



IGNITION
PARTS

Ignition Coils

CATALOGUE 2017/18



© ROBERT CLAYSON



www.ngkntk.co.uk

facebook.com/ngksparkplugsuk

twitter.com/ngk_uk

NGK UK YouTube

ngkntk.co.uk



WE'VE GOT HIS BACK

Sébastien Ogier
Four times World Rally Champion
driving the M-Sport Fiesta RS WRC



IGNITION
PARTS



VEHICLE
ELECTRONICS

SPARK PLUGS : GLOW PLUGS : COILS : SENSORS FROM THE WORLD'S NO.1

CONTENTS

TECHNICAL INFORMATION

Ignition Coil Design _____	2-3
Notes on Catalogue Use _____	4
New Ignition Coil Additions to Range _____	4
Supersessions _____	4

IGNITION COIL APPLICATIONS

Alfa Romeo _____	5-7	FSO _____	48	Mini _____	79-80	Subaru _____	120-121
Aston Martin _____	7	Honda _____	48-51	Mitsubishi _____	80-82	Suzuki _____	121-122
Audi _____	7-16	Hyundai _____	51-54	Morgan _____	83	Talbot _____	122-123
Austin/Morris (see also Rover) _____	16-17	Infiniti _____	54	Morris - (see Austin/Morris) _____	83	Toyota _____	123-126
Bentley _____	17	Isuzu _____	54	Nissan _____	83-86	Triumph _____	126-127
BMW _____	18-27	Jaguar/Daimler _____	54-56	Opel _____	86	TVR _____	128
Cadillac _____	27	Jeep _____	57	Peugeot _____	87-93	Vauxhall/Opel _____	128-138
Chevrolet _____	27-28	Kia _____	58-59	Porsche _____	93-94	Volkswagen _____	138-149
Chrysler _____	28	Lada _____	59-60	Proton _____	94	Volvo _____	149-156
Citroen _____	28-34	Lamborghini _____	60	Reliant _____	95	Yugo _____	156
Dacia _____	34	Lancia _____	60	Renault _____	95-106		
Daewoo _____	34-35	Land Rover _____	60-62	Rolls Royce _____	106		
Daihatsu _____	35-36	LDV _____	62	Rover _____	106-110		
Dodge _____	36	Lexus _____	62	Saab _____	110-112		
Ferrari _____	36	Lotus _____	62-63	Seat _____	112-115		
Fiat _____	37-40	Mazda _____	63-65	Skoda _____	115-119		
Ford _____	40-48	Mercedes Benz _____	65-77	Smart _____	119		
		MG _____	77-79	Ssangyong _____	119-120		

PRODUCT INFORMATION

Ignition Coil Images _____	158 - 193
Conversion Chart _____	194 - 215

This catalogue is intended for vehicles/engines officially imported or manufactured in the UK and supersedes all previous versions, which should be disposed of. Whilst every care is taken in compiling these lists of applications, they are given for general guidance only, and do not constitute any contractual term, representation or warranty and as such NGK Spark Plugs (UK) Ltd. do not accept any responsibility in respect of any claim whatsoever and howsoever caused arising from the publication of this catalogue.

NGK and NTK products are designed solely for use in automotive, motorcycle, marine, horticultural, agricultural, commercial, industrial, and stationary engines.

NGK and NTK products should not be used in aircraft engines.

Resistor spark plugs should always be used where they are recommended by the manufacturer. The use of non-resistor plugs could, in some cases, result in interference with and/or damage to electronic components.

NGK and NTK products listed in the application guides do not apply to racing or modified engines, except where explicitly stated.

IGNITION COIL DESIGN

Various types of ignition coil are used depending on the technology used on a vehicle. The range of NGK ignition coil types are described below along with an explanation of the NGK ignition coil part number. Please note that diagrams are for illustrative purposes only. Ignition cables are not included unless specified.

DISTRIBUTOR COILS U1000

NGK **U1** type ignition coils supply the spark plugs with the high voltage via a mechanical ignition distributor. Usually one ignition coil per vehicle is fitted of this design.

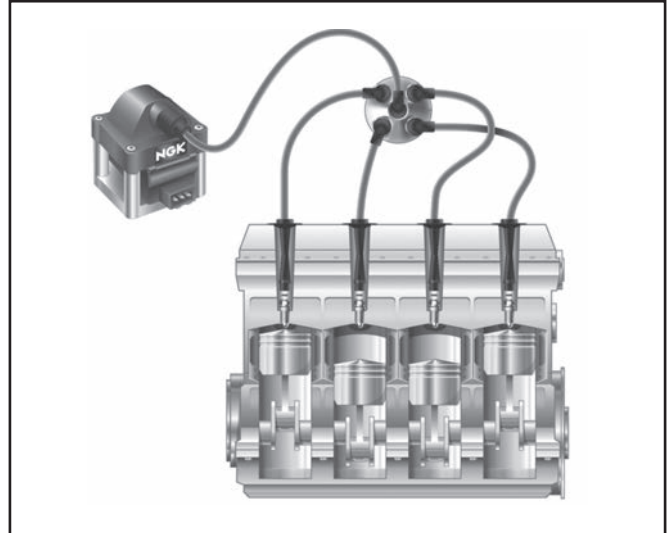

BLOCK IGNITION COILS U2000

NGK **U2** ignition coils are often referred to as block ignition coils. This type of coil supplies multiple spark plugs with high voltage through ignition cables connected directly to the coil. No mechanical distributor is required.

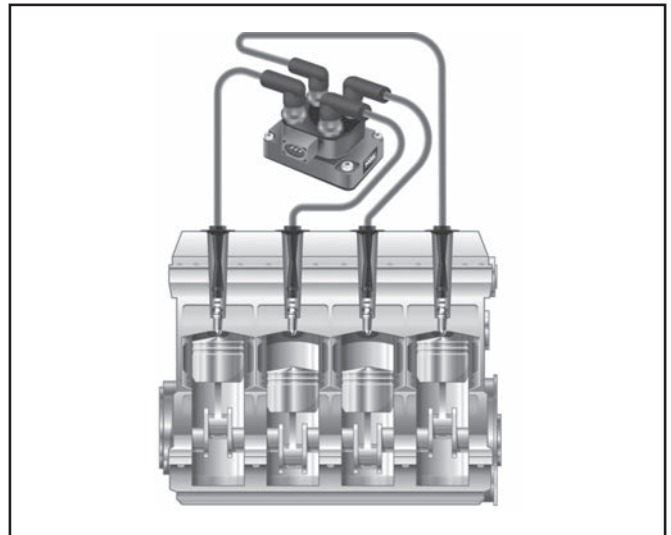

BLOCK IGNITION COILS (PAIRED) U3000

As with the U2 type, NGK **U3** type ignition coils are block type but supply only two spark plugs per coil therefore several of these coils may be required depending on the quantity of spark plugs present. Spark plugs are connected via ignition cables.

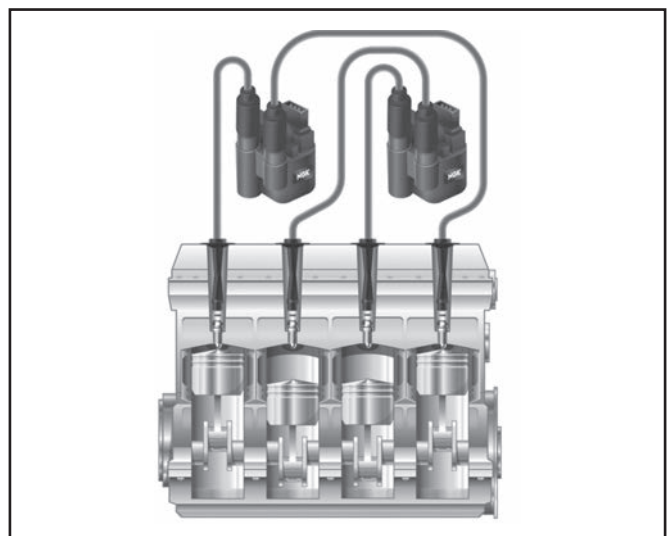

PLUG TOP COILS (PAIRED) U4000

NGK **U4** ignition coils are fitted directly on to the spark plug (commonly referred to as a plug top coil) but also supply an additional spark plug via an ignition cable.

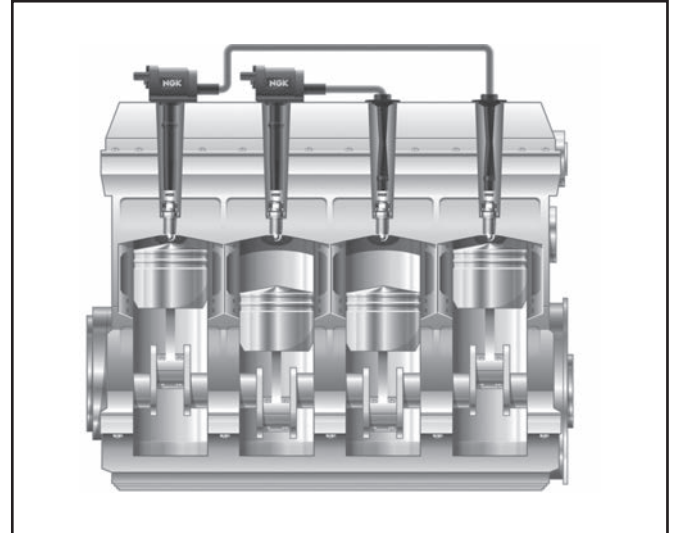

PLUG TOP COILS U5000

As with NGK **U4** type ignition coils, the U5 type fits directly on to the spark plug. With this type, one ignition coil is used per spark plug therefore no ignition cables are used.

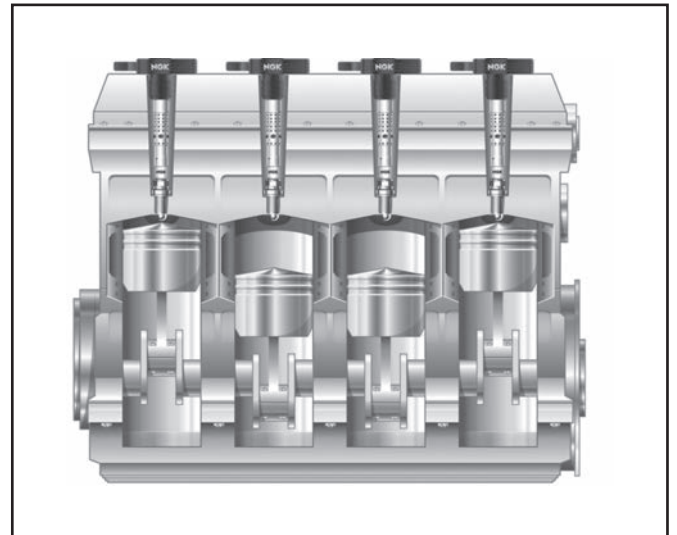

IGNITION COIL RAIL U6000

The NGK **U6** type of coil supplies multiple spark plugs with high voltage via an ignition rail. Usually no ignition cables are used as the coil connects directly to the spark plugs similar to the plug top design, however exceptions include U6036 and U6037 (please refer to images at the rear of the catalogue for more information).

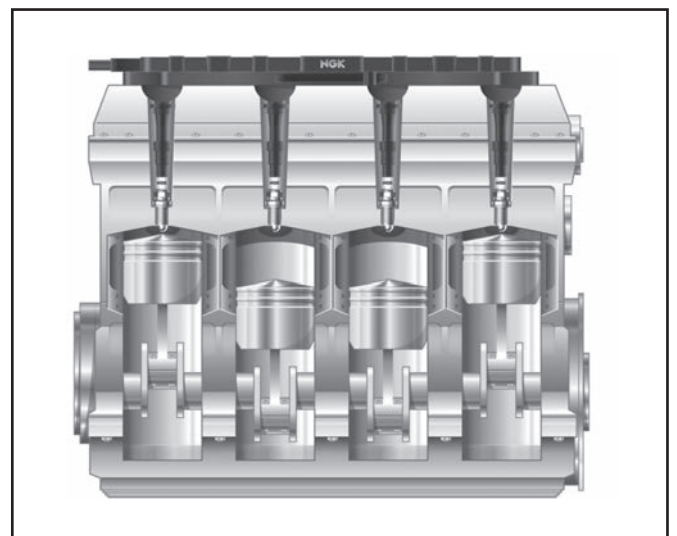

NOTES ON CATALOGUE USE

Always refer to fitting instructions if provided with component and adhere to the vehicle manufacturers repair procedure when replacing parts.

The application data within this catalogue contains a column headed 'Number of Pins'. This detail refers to the number of pins in the connector as illustrated below.



The number of pins within a connector block are shown here.
This plug top coil has 4 pins.



This block ignition coil has 3 pins
in the connector.

NEW IGNITION COIL ADDITIONS TO RANGE

These are new additions to this catalogue that have new part numbers not previously stocked by NGK Spark Plugs (UK) Ltd.

STOCK NO.	NTK PART NO.	MANUFACTURER
U5130	49072	VAUXHALL / OPEL
U5134	49073	HONDA
U5210	49060	MITSUBISHI
U5225	49070	HONDA
U5244	49066	VAUXHALL / SAAB
U5309	49047	FIAT / VAUXHALL / OPEL
U5310	49048	HYUNDAI
U5314	49052	HYUNDAI
U5315	49053	VAUXHALL / OPEL

STOCK NO.	NTK PART NO.	MANUFACTURER
U5316	49054	HYUNDAI
U5317	49055	HYUNDAI
U5319	49057	SUBARU
U5320	49058	FORD
U5322	49061	BMW
U5323	49062	FORD
U6052	49075	RENAULT
U6053	49076	CHEVROLET
U6054	49077	VAUXHALL / OPEL

SUPERSESSIONS

Original Part No.	Stock Number	Replaced By	Replacement Part No.	Stock Number
U2038	48169	→	U6055	49086
U3013	48175	→	Obsolete	
U5009	48033	→	U5050	48026
U5059	48221	→	U5181	48562

LITRE / MODEL	BODY	ENGINE TYPE	DATE	ADDITIONAL INFORMATION	FITMENT INFORMATION	NO. OF COILS	NO. OF PINS	PART NO.	STOCK NO.
ALFA ROMEO									
33 (83→90)									
1.3		AR30168, AR30587	02/86→05/87		For Vehicles Without Distributor	2	2	U3001	48013
1.3		AR30502	06/83→02/86		For Vehicles Without Distributor	2	2	U3001	48013
75 (86→92)									
3.0		AR06120, AR06124	10/87→06/90		Without CAT, With Distributor	1	2	U1076	48339
3.0		AR61503	06/90→02/92		For Vehicles With Distributor	1	2	U1076	48339
145 (94→01)									
1.6		AR38201, AR67601	02/99→01/01	Oval Connector, From Ch. No.: 3174688		4	2	U4007	48149
1.6		AR67601	03/97→02/99	Angular Connector, To Ch. No.: 3174687		4	2	U4003	48103
1.8		AR32201, AR38401, AR67106	03/97→12/98	Angular Connector		4	2	U4003	48103
1.8		AR32201, AR38401, AR67106	03/98→01/01	Oval Connector		4	2	U4007	48149
2.0		AR32301	05/99→01/01	Oval Connector		4	2	U4007	48149
2.0		AR67204	02/96→05/99	Angular Connector		4	2	U4003	48103
146 (95→01)									
1.6		AR33201	06/95→12/96		For Vehicles Without Distributor	1	3	U2006	48025
1.6		AR38201, AR67601	02/99→01/01	Oval Connector, From Ch. No.: 0165089		4	2	U4007	48149
1.6		AR67601	03/97→02/99	Angular Connector, To Ch. No.: 0165088		4	2	U4003	48103
1.7		AR33401	06/95→12/96		For Vehicles Without Distributor	1	3	U2006	48025
1.8		AR32201, AR38401, AR67106	03/97→01/01	Angular Connector		4	2	U4003	48103
1.8		AR32201, AR38401, AR67106	03/98→01/01	Oval Connector		4	2	U4007	48149
2.0		AR32301	05/99→01/01	Oval Connector		4	2	U4007	48149
2.0		AR67204	02/96→05/99	Angular Connector		4	2	U4003	48103
147 (01→09)									
1.6		AR32104	02/01→12/09	Oval Connector		4	2	U4004	48104
1.6		AR37203	01/04→09/06	Oval Connector		4	2	U4004	48104
2.0		AR32310	06/01→12/09	Oval Connector		4	2	U4004	48104
3.2, GTA		932A.000	03/03→11/05			6	3	U5040	48154
155 (92→98)									
1.8		AR67101	07/92→06/93		For Vehicles Without Distributor	1	3	U2006	48025
1.8		AR67101, AR67102	06/95→07/96		For Vehicles Without Distributor	1	3	U2006	48025
1.8		AR67106	07/96→12/97	Angular Connector		4	2	U4003	48103
2.0		AR67201	07/93→06/95		For Vehicles Without Distributor	1	3	U2006	48025
2.0		AR67204	06/95→12/97	Angular Connector		4	2	U4003	48103
2.0, Cloverleaf 4		AR67203	01/94→06/95		For Vehicles Without Distributor	2	2	U3001	48013
2.5		AR67301	07/92→09/96			1	4	U2046	48197
156 (98→06)									
1.6	Est	AR32102, AR67601	06/00→12/03	Oval Connector		4	2	U4007	48149
1.6	Est	AR32103, AR32104	06/00→12/03	Oval Connector		4	2	U4004	48104
1.6	Est	AR67601	06/00→12/03	Angular Connector		4	2	U4003	48103
1.6	Sal	AR32102, AR67601	04/00→09/05	Oval Connector		4	2	U4007	48149
1.6	Sal	AR32103, AR32104	04/00→09/05	Oval Connector		4	2	U4004	48104
1.6	Sal	AR67601	04/00→09/05	Angular Connector		4	2	U4003	48103
1.8	Est	AR32201	06/00→10/00	Oval Connector		4	2	U4004	48104
1.8	Est	AR32205	05/02→03/06	Oval Connector		4	2	U4004	48104
1.8	Sal	AR32201	01/98→10/00	Oval Connector		4	2	U4007	48149
1.8	Sal	AR32205	05/02→09/05	Oval Connector		4	2	U4004	48104
2.0	Est	937A1.000	06/00→03/06			4	4	U5042	48161
2.0	Est	AR32310	06/00→06/02	Oval Connector		4	2	U4004	48104
2.0	Sal	937A1.000	05/02→09/05			4	4	U5042	48161
2.0	Sal	AR32301	01/98→10/00	Oval Connector		4	2	U4007	48149
2.0, Selespeed	Est	AR32301	06/00→10/00	Oval Connector		4	2	U4004	48104
2.5	Est, Sal	AR32405	10/00→10/03			6	3	U5040	48154
3.2, GTA	Est	932A.000	05/02→12/05			6	3	U5040	48154
3.2, GTA	Sal	932A.000	05/02→09/05			6	3	U5040	48154

LITRE / MODEL	BODY	ENGINE TYPE	DATE	ADDITIONAL INFORMATION	FITMENT INFORMATION	NO. OF COILS	NO. OF PINS	PART NO.	STOCK NO.
ALFA ROMEO (continued)									
159 (06→12)									
1.7, 1750 TBi	Est, Sal	939B1.000	08/09→11/11			1	6	U6001	48004
1.8, MPI	Est, Sal	939A4.000	01/08→04/10			1	6	U6001	48004
1.9, JTS	Est	939A6.000	06/06→04/08			4	4	U5042	48161
1.9, JTS	Sal	939A6.000	01/06→04/08			4	4	U5042	48161
2.2, JTS	Est	939A5.000	06/06→03/11			1	6	U6027	48151
2.2, JTS	Sal	939A5.000	01/06→03/11			1	6	U6027	48151
3.2, JTS Q4	Est	939A.000	06/06→06/10			6	4	U5049	48174
3.2, JTS Q4	Sal	939A.000	01/06→06/10			6	4	U5049	48174
164 (88→98)									
2.0		AR64103	05/93→04/98		For Vehicles Without Distributor	1	3	U2006	48025
3.0		AR66301, AR66302	05/93→04/98			6	3	U5040	48154
3.0, Cloverleaf		AR64304	05/93→04/98			1	4	U2046	48197
3.0, Cloverleaf		AR64304	05/93→04/98			6	3	U5040	48154
3.0, Cloverleaf			10/90→10/92			6	3	U5040	48154
166 (99→03)									
2.0		AR34103	01/99→10/00	Oval Connector		2	2	U4007	48149
2.5		AR34201	01/99→10/00			6	3	U5040	48154
3.0		AR34301	01/99→10/00			6	3	U5040	48154
166 (03→05)									
3.2		936A.000	04/04→12/05			6	3	U5040	48154
Alfetta									
2.0		AR01655, AR01713, AR10520	01/80→10/83		For Vehicles With Distributor	1	2	U1065	48302
2.0, Gold Cloverleaf		AR01655, AR01713, AR10520	02/84→12/84		For Vehicles With Distributor	1	2	U1065	48302
Arna									
1.2		AR30102	11/84→05/86		For Vehicles With Distributor	1	2	U1079	48342
1.5, Ti		AR30182	05/85→05/86		For Vehicles With Distributor	1	2	U1079	48342
Brera (06→11)									
2.2, Brera S JTS		939A5.000	05/08→12/09			1	6	U6027	48151
2.2, JTS		939A5.000	04/06→03/11			1	6	U6027	48151
3.2, JTS Q4		939A.000	04/06→03/11			6	4	U5049	48174
Giulietta									
1.6		AR01600	01/80→04/85		For Vehicles With Distributor	1	2	U1079	48342
1.8		AR01678	01/80→04/85		For Vehicles With Distributor	1	2	U1079	48342
2.0		AR01655, AR11671	07/80→04/85		For Vehicles With Distributor	1	2	U1065	48302
Giulietta (10→)									
1.4, TB 120		198A4.000	05/10→			4	3	U5096	48286
GT (04→11)									
1.8 TS		AR32205	09/07→04/08	Oval Connector		2	2	U4004	48104
1.8 TS Cloverleaf		AR32205	08/09→08/10	Oval Connector		2	2	U4004	48104
2.0		932A2.000, 937A1.000	03/04→09/10			4	4	U5042	48161
3.2		936A.000	04/04→10/08			6	3	U5040	48154
GTV (80→87)									
2.0		AR01655, AR06212	01/80→01/86		For Vehicles With Distributor	1	2	U1065	48302
GTV (96→05)									
2.0		AR16201	04/96→08/98	Angular Connector		4	2	U4003	48103
2.0		AR16201	04/96→09/98	Oval Connector		4	2	U4007	48149
2.0		AR32301	09/98→08/00	Oval Connector		2	2	U4007	48149
2.0		AR32310	04/96→09/98	Oval Connector		4	2	U4004	48104
2.0, JTS		937A1.000	09/03→10/05			4	4	U5042	48161
2.0, T Spark		AR32310	02/04→10/05	Oval Connector		4	2	U4004	48104
3.0		AR16102	09/98→10/00			6	3	U5040	48154
3.2		936A6.000	09/03→10/05			6	3	U5040	48154
MiTo (09→)									
0.9		312A2.000	03/12→			2	3	U5156	48411
1.4		199A6.000	01/09→12/11			4	3	U5115	48335
1.4, Junior		955A1.000	03/11→12/11			4	3	U5018	48061

LITRE / MODEL	BODY	ENGINE TYPE	DATE	ADDITIONAL INFORMATION	FITMENT INFORMATION	NO. OF COILS	NO. OF PINS	PART NO.	STOCK NO.
ALFA ROMEO (continued)									
MiTo (09→)									
1.4, Multiair		955A6.000	08/10→			4	3	U5115	48335
1.4, TB 120		198A4.000	01/09→08/10			4	3	U5096	48286
1.4, TB 155		199A8.000	01/09→08/10			4	3	U5096	48286
Spider (96→05)									
2.0		AR16201, AR16201	04/96→09/98	Oval Connector		4	2	U4007	48149
2.0		AR32301	09/98→08/00	Oval Connector		2	2	U4007	48149
2.0, JTS		937A1.000	09/03→12/04			4	4	U5042	48161
2.0, T Spark		AR23210	02/04→12/04	Oval Connector		4	2	U4004	48104
2.2, JTS		939A5.000	09/06→03/11			1	6	U6027	48151
3.0		AR16105	04/01→10/03			6	3	U5040	48154
3.2		936A6.000	09/03→12/04			6	3	U5040	48154
3.2, JTS Q4		939A.000	09/06→03/11			6	4	U5049	48174

ASTON MARTIN									
V8/Vantage/Volante Series 4									
5.3, V8 Oscar india		40HCA	01/80→12/86		For Vehicles With Distributor	1	2	U1076	48339

AUDI									
80 (79→86)									
1.6		DT	06/84→07/85	To Ch. No.: 81-F-220000		1	2	U1080	48343
1.6		DT	08/85→06/86	From Ch. No.: 81-G-000001		1	2	U1081	48344
1.6		DT	10/83→05/84			1	2	U1078	48341
1.6		YP	01/80→02/83			1	2	U1078	48341
1.8		DZ	08/85→07/86	From Ch. No.: 81-G-000001		1	2	U1081	48344
1.8		DZ	10/84→07/85	To Ch. No.: 81-F-220000		1	2	U1080	48343
1.8, Quattro		DZ	07/85→07/85	To Ch. No.: 85-F-220000		1	2	U1080	48343
1.8, Quattro		DZ	08/85→07/86	From Ch. No.: 85-G-000001		1	2	U1081	48344
2.0		HP, JS	10/83→05/84			1	2	U1078	48341
80 (86→91)									
1.6		RN	09/86→11/87			1	2	U1081	48344
1.8		RU	01/88→09/89			1	2	U1081	48344
1.8, Carburettor		JN, NE, PM	10/86→09/89			1	2	U1081	48344
1.8, Injection		DZ	10/86→08/91			1	2	U1081	48344
2.0		3A	09/89→10/90			1	2	U1081	48344
80 (91→95)									
2.0	Sal	ABK	10/91→12/94		Incl. Control Unit, For Vehicles With Distributor	1	3	U1001	48000
2.0	Sal	ABK	10/91→12/94		Incl. Control Unit, For Vehicles With Distributor	1	6	U1003	48039
2.0	Sal	ABT	10/91→07/92		Incl. Control Unit, For Vehicles With Distributor	1	3	U1001	48000
2.0, Avant	Est	ABK	01/93→03/95		Incl. Control Unit, For Vehicles With Distributor	1	3	U1001	48000
2.0, Avant	Est	ABK	01/93→03/95		Incl. Control Unit, For Vehicles With Distributor	1	6	U1003	48039
2.6	Sal	ABC	09/92→12/94			1	5	U2010	48037
2.6, Avant	Est	ABC	09/92→03/95			1	5	U2010	48037
2.6, Quattro	Sal	ABC	09/93→12/94			1	5	U2010	48037
2.6, Quattro Avant	Est	ABC	09/93→03/95			1	5	U2010	48037
2.8	Sal	AAH	10/91→12/92			1	5	U2010	48037
2.8, Quattro	Sal	AAH	10/91→12/93			1	5	U2010	48037
90 (84→86)									
2.0		HP, JS	08/85→08/86	From Ch. No.: 81-G-000001		1	2	U1081	48344
2.0		HP, JS	10/84→07/85	To Ch. No.: 81-F-220000		1	2	U1080	48343
2.2, Quattro		KV	08/85→08/86	From Ch. No.: 85-G-000001		1	2	U1081	48344
2.2, Quattro		KV	11/84→07/85	To Ch. No.: 85-F-220000		1	2	U1080	48343

LITRE / MODEL	BODY	ENGINE TYPE	DATE	ADDITIONAL INFORMATION	FITMENT INFORMATION	NO. OF COILS	NO. OF PINS	PART NO.	STOCK NO.
AUDI (continued)									
90 (87→91)									
2.0		PS	07/88→08/89			1	2	U1081	48344
2.2		KV	07/87→09/89			1	2	U1081	48344
2.2, Quattro		KV	07/87→09/89			1	2	U1081	48344
100 (76→84)									
2.1, Carburettor CL-5S		WB, WE	01/80→07/82			1	2	U1078	48341
2.1, Injection CL-5E		WC, WG	01/80→07/82			1	2	U1078	48341
100 (83→91)									
1.8	Sal	4B, PH, DS, JW, NP	03/85→08/86	From Ch. No.: 44-G-000001		1	2	U1081	48344
1.8	Sal	DS, JW	06/84→07/85	From Ch. No.: 44-E-220001, To Ch. No.: 44-F-300000		1	2	U1080	48343
1.8	Sal	DS, JW	08/83→05/84			1	2	U1078	48341
1.8, Avant	Est	4B, PH, DS, JW, NP	03/85→10/86	From Ch. No.: 44-G-000001		1	2	U1081	48344
1.8, Avant	Est	DS, JW	06/84→07/85	From Ch. No.: 44-E-220001, To Ch. No.: 44-F-300000		1	2	U1080	48343
1.8, Avant	Est	DS, JW	08/83→05/84			1	2	U1078	48341
2.0	Sal	KP, RT	01/88→11/90			1	2	U1081	48344
2.0	Sal	KP, RT	03/85→07/85	To Ch. No.: 44-F-300000		1	2	U1080	48343
2.0	Sal	KP, RT	08/85→12/87	From Ch. No.: 44-G-000001		1	2	U1081	48344
2.0, Avant	Est	KP, RT	10/86→11/90			1	2	U1081	48344
2.1, Avant	Est	WC	05/83→07/84			1	2	U1078	48341
2.2	Sal	KU	01/85→07/85	To Ch. No.: 44-F-300000		1	2	U1080	48343
2.2	Sal	KU	08/85→12/88	From Ch. No.: 44-G-000001		1	2	U1081	48344
2.2, Avant	Est	KU	01/85→07/85	To Ch. No.: 44-F-300000		1	2	U1080	48343
2.2, Avant	Est	KU	08/85→12/88	From Ch. No.: 85-G-000001		1	2	U1081	48344
2.2, Quattro	Sal	KU	08/84→07/85			1	2	U1080	48343
2.2, Quattro	Sal	KU	08/85→12/88			1	2	U1081	48344
2.2, Turbo	Sal	MC	09/89→11/90	From Ch. No.: 44-J-250001	Incl. Control Unit, For Vehicles With Distributor	1	3	U1001	48000
2.2, Turbo Quattro	Sal	MC	09/89→11/90	From Ch. No.: 44-J-250001	Incl. Control Unit, For Vehicles With Distributor	1	3	U1001	48000
2.3	Sal	NF	09/89→11/90		Incl. Control Unit, For Vehicles With Distributor	1	3	U1001	48000
2.3, Quattro	Sal	NF	09/89→11/90	From Ch. No.: 44-J-200100	Incl. Control Unit, For Vehicles With Distributor	1	3	U1001	48000
100 (91→94)									
2.0	Sal	AAD, ABK	05/91→06/94		Incl. Control Unit, For Vehicles With Distributor	1	3	U1001	48000
2.0	Sal	AAD, ABK	05/91→06/94			1	2	U1081	48344
2.0, Avant	Est	AAD, ABK	10/91→06/94		Incl. Control Unit, For Vehicles With Distributor	1	3	U1001	48000
2.0, Avant	Est	AAD, ABK	10/91→06/94			1	2	U1081	48344
2.6	Sal	ABC	10/92→06/94			1	5	U2010	48037
2.6, Avant	Est	ABC	10/92→06/94			1	5	U2010	48037
2.8	Sal	AAH	05/91→12/92			1	5	U2010	48037
2.8, Avant	Est	AAH	10/91→12/92			1	5	U2010	48037
2.8, Quattro	Sal	AAH	05/91→06/94			1	5	U2010	48037
2.8, Quattro Avant	Est	AAH	10/91→06/94			1	5	U2010	48037
A1 (10→)									
1.2, TFSI		CBZA	08/10→		For Vehicles Without Distributor	1	4	U2003	48010
1.4, TFSI		CPTA	01/13→			4	4	U5153	48408
1.4, TFSI		CAVG, CTHG, CTJA	01/11→			4	4	U5002	48003
1.4, TFSI		CAXA	08/10→			4	4	U5002	48003
2.0, quattro		CDLH	06/12→03/13			4	4	U5015	48042
A2 (00→05)									
1.4		AUA	08/00→04/02		For Vehicles Without Distributor	1	4	U2003	48010
1.4		BBY	11/01→08/05			4	4	U5002	48003
1.6, FSI		BAD	07/02→02/05			4	4	U5002	48003
A3 (96→03)									
1.6		AEH, AKL, APF, AVU, BFQ	09/96→06/03		For Vehicles Without Distributor	1	4	U2003	48010

LITRE / MODEL	BODY	ENGINE TYPE	DATE	ADDITIONAL INFORMATION	FITMENT INFORMATION	NO. OF COILS	NO. OF PINS	PART NO.	STOCK NO.
AUDI (continued)									
A3 (96→03)									
1.8		AGN, APG	09/96→06/03		For Vehicles Without Distributor	1	4	U2003	48010
1.8, T		AGU	12/96→04/01			4	3	U5004	48008
1.8, T		AGU, AUM	05/01→08/03			4	4	U5003	48005
1.8, T		AQA, ARZ	12/96→08/03			4	4	U5022	48082
1.8, T Quattro		AJQ	06/99→12/02			4	4	U5022	48082
1.8, T Quattro		ARY	06/99→12/02			4	4	U5003	48005
A3 (03→13)									
1.2, TFSI	Cnv, Hbk	CBZB	04/10→		For Vehicles Without Distributor	1	4	U2003	48010
1.4, TFSi	Hbk	CAXC, CMSA	09/07→			4	4	U5002	48003
1.6	Cnv	BSE	09/08→12/10		For Vehicles Without Distributor	1	4	U2003	48010
1.6	Hbk	BGU, BSE, BSF, CCSA, CMXA	06/03→		For Vehicles Without Distributor	1	4	U2003	48010
1.6, FSI	Hbk	BAG, BLF, BLP	08/03→12/07			4	4	U5002	48003
1.8, TFSi	Cnv	BZB, CDAA	04/08→			4	4	U5015	48042
1.8, TFSi	Hbk	BYT, BZB, CDAA	01/07→			4	4	U5015	48042
2.0, FSi	Hbk	AXW, BLR, BLX, BLY, BMB, BVY, BVZ	06/03→08/07			4	4	U5015	48042
2.0, TFSi	Cnv	CAWB, CCZA	04/08→			4	4	U5015	48042
2.0, TFSi	Hbk	AXX, BPY, BWA, CAWB, CBFA, CCZA	09/04→	To Ch. No.: 8P6A030000, 8P6B003500		4	4	U5015	48042
2.0, TFSi Quattro	Hbk	AXX, BWA, CCZA	09/04→	To Ch. No.: 8P6A030000, 8P6B003500		4	4	U5015	48042
3.2, Quattro	Hbk	BDB, BMJ, BUB	07/03→10/08			6	4	U5020	48065
A3 (12→)									
1.2, TFSI	Hbk	CJZA	12/12→			4	4	U5153	48408
1.4, TFSI	Hbk, Sal, Cnv	CPTA	12/12→			4	4	U5153	48408
1.8, TFSI		CJSA, CJSB	05/12→			4	4	U5154	48409
1.8, TFSI Quattro		CJSA, CJSB	05/12→			4	4	U5154	48409
2.0	Hbk, Cnv	CJXC	04/14→			4	4	U5154	48409
A4 (95→01)									
1.6	Sal	ADP, AHL, ALZ, ANA, ARM	03/95→11/00		For Vehicles Without Distributor	1	4	U2003	48010
1.6, Avant	Est	ADP, AHL, ALZ, ANA, ARM	03/96→06/01		For Vehicles Without Distributor	1	4	U2003	48010
1.8	Sal	ADR, APT, ARG, AVV	03/95→11/00		Incl. Control Unit	1	3	U6037	48048
1.8, Avant	Est	ADR, APT, ARG, AVV	03/96→06/01		Incl. Control Unit	1	3	U6037	48048
1.8, T	Sal	AEB, ANB, APU, ARK	03/95→11/00			4	3	U5004	48008
1.8, T	Sal	AWT	03/95→11/00			4	4	U5003	48005
1.8, T Avant	Est	AEB, ANB, APU	03/96→06/01			4	3	U5004	48008
1.8, T Avant	Est	AWT	03/96→06/01			4	4	U5003	48005
1.8, T Avant Quattro	Est	AJL	05/99→06/01			4	3	U5004	48008
1.8, T Quattro	Sal	AJL	05/99→11/00			4	3	U5004	48008
2.4	Sal	AGA, ALF, AML, APS, ARJ	09/97→11/00			1	5	U2010	48037
2.4, Avant	Est	AGA, ALF, AML, APS, ARJ	09/97→06/01			1	5	U2010	48037
2.6	Sal	ABC	03/95→09/97	With Bracket		1	6	U2013	48049
2.6, Avant	Est	ABC	03/96→09/97	With Bracket		1	6	U2013	48049
2.6, Quattro	Sal	ABC	03/95→12/96	With Bracket		1	6	U2013	48049
2.8	Sal	ACK, ALG, AMX, APR, AQD	10/96→11/99			1	5	U2010	48037
2.8, Avant	Est	ACK, ALG, AMX, APR, AQD	10/96→11/99			1	5	U2010	48037
2.8, Avant Quattro	Est	ACK, ALG, AMX, APR, AQD	10/96→06/01			1	5	U2010	48037
2.8, Quattro	Sal	ACK, ALG, AMX, APR, AQD	10/96→11/00			1	5	U2010	48037
A4 (01→04)									
1.6	Sal	ALZ	06/01→12/04		For Vehicles Without Distributor	1	4	U2003	48010
1.6, Avant	Est	ALZ	09/01→12/04		For Vehicles Without Distributor	1	4	U2003	48010
1.8	Sal	AVJ	12/00→06/02			4	4	U5003	48005
1.8	Sal	BFB	07/02→10/03			4	4	U5003	48005
1.8, Avant	Est	AVJ	09/01→06/02			4	4	U5003	48005
1.8, Avant	Est	BFB	07/02→10/03			4	4	U5003	48005
1.8, Quattro	Sal	AVJ	12/00→06/02			4	4	U5003	48005
1.8, Quattro	Sal	BFB	07/02→10/03			4	4	U5003	48005

LITRE / MODEL	BODY	ENGINE TYPE	DATE	ADDITIONAL INFORMATION	FITMENT INFORMATION	NO. OF COILS	NO. OF PINS	PART NO.	STOCK NO.
AUDI (continued)									
A4 (01→04)									
1.8, Quattro Avant	Est	AVJ	09/01→06/02			4	4	U5003	48005
1.8, Quattro Avant	Est	BFB	07/02→10/03			4	4	U5003	48005
1.8, T	Sal	BEX	09/03→12/04			4	4	U5003	48005
1.8, T Avant	Est	BEX	09/03→12/04			4	4	U5003	48005
1.8, T Quattro	Sal	BEX	09/03→12/04			4	4	U5003	48005
1.8, T Quattro Avant	Est	BEX	09/03→12/04			4	4	U5003	48005
2.0	Sal	ALT	12/00→12/04			4	4	U5013	48040
2.0, Avant	Est	ALT	09/01→12/04			4	4	U5013	48040
2.0, FSi	Sal		07/02→12/04			4	4	U5014	48041
2.0, FSi Avant	Est		07/02→12/04			4	4	U5014	48041
2.4	Sal	BDV	09/01→12/04			1	5	U2010	48037
2.4, Avant	Est	BDV	09/01→12/04			1	5	U2010	48037
3.0, Quattro	Sal	ASN, AVK	12/00→12/04			6	4	U5013	48040
3.0, Quattro Avant	Est	ASN, AVK	09/01→12/04			6	4	U5013	48040
A4 (01→06)									
1.8	Cnv	BFB	12/02→05/06			4	4	U5003	48005
1.8, Quattro	Cnv	BFB	10/03→05/06			4	4	U5003	48005
2.4	Cnv	BDV	07/02→12/05			1	5	U2010	48037
3.0	Cnv	ASN	07/02→12/05			6	4	U5013	48040
3.0, Quattro	Cnv	ASN	10/03→12/05			6	4	U5013	48040
A4 (04→08)									
1.6	Sal	ALZ	11/04→09/06		For Vehicles Without Distributor	1	4	U2003	48010
1.6, Avant	Est	ALZ	11/04→09/06		For Vehicles Without Distributor	1	4	U2003	48010
1.8, T	Sal	BFB	11/04→06/08			4	4	U5003	48005
1.8, T Avant	Est	BFB	11/04→06/08			4	4	U5003	48005
1.8, T Quattro	Sal	BFB	11/04→06/08			4	4	U5003	48005
1.8, T Quattro Avant	Est	BFB	11/04→06/08			4	4	U5003	48005
2.0	Sal	ALT	11/04→06/08			4	4	U5003	48005
2.0, Avant	Est	ALT	11/04→06/08			4	4	U5003	48005
2.0, DTM Quattro	Sal	BUL	09/05→04/07			4	4	U5015	48042
2.0, TFSi	Sal	BGB, BPG, BWE, BWT	11/04→06/08			4	4	U5015	48042
2.0, TFSi Avant	Est	BGB, BWE	11/04→06/08			4	4	U5015	48042
2.0, TFSi Avant S Line	Est	BUL	12/05→06/08			4	4	U5015	48042
2.0, TFSi Quattro	Sal	BGB, BPG, BWE, BWT	11/04→06/08			4	4	U5015	48042
2.0, TFSi Quattro Avant	Est	BGB, BWE	11/04→06/08			4	4	U5015	48042
2.0, TFSi Quattro Avant S Line	Est	BUL	12/05→06/08			4	4	U5015	48042
2.0, TFSi S Line	Sal	BUL	12/05→06/08			4	4	U5015	48042
3.2 FSI	Sal	AUK	01/05→06/08			6	4	U5014	48041
3.2 FSI Avant	Est	AUK	01/05→06/08			6	4	U5014	48041
3.2 FSI Quattro	Sal	AUK, BKH	01/05→06/08			6	4	U5014	48041
3.2 FSI Quattro Avant	Est	AUK	01/05→06/08			6	4	U5014	48041
A4 (06→12)									
1.8, T		BFB	04/06→03/09			4	4	U5003	48005
1.8, TFSi 120	Sal	CABA	04/08→08/12			4	4	U5015	48042
1.8, TFSi 120	Sal	CDHA	04/08→08/12			4	4	U5014	48041
1.8, TFSi 120 Avant	Est	CDHA	02/09→08/12			4	4	U5014	48041
1.8, TFSi 160	Sal	CABB, CCUA, CDHB	04/08→08/12			4	4	U5015	48042
1.8, TFSi 160 Avant	Est	CABB, CCUA, CDHB	04/08→08/12			4	4	U5015	48042
2.0, ALLROAD TFSi	Est	CDNC, CPMA	04/09→08/12			4	4	U5015	48042
2.0, TFSi		BWE, BWT	04/06→03/09			4	4	U5015	48042
2.0, TFSi 211	Sal	CADA, CAEB, CDNC	07/08→08/12			4	4	U5015	48042
2.0, TFSi 211 Avant	Est	CADA, CDNC	07/08→08/12			4	4	U5015	48042
2.0, TFSi 211 Quattro	Sal	CAEB, CDNC, CPMA	07/08→08/12			4	4	U5015	48042
2.0, TFSi 211 Quattro Avant	Est	CDNC	07/08→08/12			4	4	U5015	48042
3.2, FSI	Sal	CALA	02/09→08/12			6	4	U5014	48041
3.2, FSI Avant	Est	CALA	02/09→08/12			6	4	U5014	48041

LITRE / MODEL	BODY	ENGINE TYPE	DATE	ADDITIONAL INFORMATION	FITMENT INFORMATION	NO. OF COILS	NO. OF PINS	PART NO.	STOCK NO.
AUDI (continued)									
A4 (06→10)									
3.2, FSI Quattro	Sal	CALA	04/08→08/12			6	4	U5014	48041
3.2, FSI Quattro		AUK	04/06→03/09			6	4	U5014	48041
3.2, FSI Quattro Avant	Est	CALA	04/08→08/12			6	4	U5014	48041
A4 (11→)									
1.8, TFSI	Sal	CABA	12/11→			4	4	U5015	48042
1.8, TFSI	Sal	CDHA	12/11→			4	4	U5014	48041
1.8, TFSI	Est	CJEB	12/11→			4	4	U5154	48409
1.8, TFSI	Hbk	CJEB	12/11→			4	4	U5154	48409
1.8, TFSI Avant	Est	CDHA	12/11→			4	4	U5014	48041
2.0, Allroad TFSI	Est	CDNC, CPMA	12/11→			4	4	U5015	48042
2.0, TFSI	Sal	CADA, CAEB, CDNC	12/11→			4	4	U5015	48042
2.0, TFSI Avant	Est	CADA, CDNC	12/11→			4	4	U5015	48042
2.0, TFSI Quattro	Sal	CAEB, CDNC, CPMA	12/11→			4	4	U5015	48042
2.0, TFSI Quattro Avant	Est	CDNC	12/11→			4	4	U5015	48042
A5 (07→)									
1.8, TFSI 160	Cnv, Cpe	CDHB	12/09→03/12			4	4	U5015	48042
1.8, TFSI 170	Cpe	CABD	11/07→10/08			4	4	U5015	48042
1.8, TFSI 170	Cpe	CJEB	09/11→			4	4	U5154	48409
1.8, TFSI 170	Cnv	CJEB	09/11→			4	4	U5154	48409
2.0, TFSI 180	Cpe	CDNB	11/08→03/12			4	4	U5015	48042
2.0, TFSI 180	Hbk	CDNB	09/09→03/12			4	4	U5015	48042
2.0, TFSI 211	Cnv	CAEB, CDNC	03/09→			4	4	U5015	48042
2.0, TFSI 211	Cpe	CDNC	06/08→			4	4	U5015	48042
2.0, TFSI 211	Hbk	CDNC	09/09→			4	4	U5015	48042
2.0, TFSI 211 Quattro	Cnv	CAEB, CDNC	08/09→			4	4	U5015	48042
2.0, TFSI 211 Quattro	Cpe	CAEB, CDNC	06/08→			4	4	U5015	48042
2.0, TFSI 211 Quattro	Hbk	CDNC	09/09→			4	4	U5015	48042
3.0, TFSI 272 Quattro	Cnv	CMUA	11/11→			6	4	U5014	48041
3.0, TFSI 272 Quattro	Cpe	CMUA	12/11→			6	4	U5014	48041
3.2, FSI	Cnv	CALA	03/09→03/12			6	4	U5014	48041
3.2, FSI	Cpe	CALA	01/08→03/12			6	4	U5014	48041
3.2, FSI Quattro	Cnv	CALA	08/09→03/12			6	4	U5014	48041
3.2, FSI Quattro	Cpe	CALA	01/08→03/12			6	4	U5014	48041
3.2, FSI Quattro	Hbk	CALA	09/09→03/12			6	4	U5014	48041
A6 (94→97)									
1.8	Sal	ADR	12/95→08/97		Incl. Control Unit	1	3	U6037	48048
1.8, Avant	Est	ADR	12/95→08/97		Incl. Control Unit	1	3	U6037	48048
2.0	Sal	ABK	06/94→12/96		Incl. Control Unit, For Vehicles With Distributor	1	3	U1001	48000
2.6	Sal	ABC	06/94→05/97			1	5	U2010	48037
2.6, Avant	Est	ABC	06/94→08/97			1	5	U2010	48037
2.8	Sal	ACK	12/95→05/97			1	5	U2010	48037
2.8, Avant	Est	ACK	12/95→08/97			1	5	U2010	48037
2.8, Avant Quattro	Est	AAH, AEJ	06/94→12/95			1	5	U2010	48037
2.8, Avant Quattro	Est	ACK	12/95→08/97			1	5	U2010	48037
2.8, Quattro	Sal	AAH, AEJ	06/94→12/95			1	5	U2010	48037
2.8, Quattro	Sal	ACK	12/95→05/97			1	5	U2010	48037
A6 (97→05)									
1.8	Sal	AEB, ARK, ANB, APU	05/97→06/04			4	3	U5004	48008
1.8	Sal	APU	05/97→04/01		Incl. Control Unit	1	3	U6037	48048
1.8	Sal	AWT	05/00→06/04			4	4	U5003	48005
1.8, Avant	Est	AEB, ANB, APU	02/98→04/01			4	3	U5004	48008
1.8, Avant	Est	APU	11/98→04/01		Incl. Control Unit	1	3	U6037	48048
1.8, Avant	Est	AWT	05/00→01/05			4	4	U5003	48005
1.8, Avant Quattro	Est	AEB, ARK, ANB, APU	11/99→05/01			4	3	U5004	48008
1.8, Avant Quattro	Est	AWT	05/00→09/03			4	4	U5003	48005
1.8, Quattro	Sal	AEB, ANB, APU	11/99→05/01			4	3	U5004	48008
1.8, Quattro	Sal	APU	11/99→05/01		Incl. Control Unit	1	3	U6037	48048

LITRE / MODEL	BODY	ENGINE TYPE	DATE	ADDITIONAL INFORMATION	FITMENT INFORMATION	NO. OF COILS	NO. OF PINS	PART NO.	STOCK NO.
AUDI (continued)									
A6 (97→05)									
1.8, Quattro	Sal	AWT	05/00→09/03			4	4	U5003	48005
2.0	Sal	ALT	08/01→06/04			5	4	U5013	48040
2.0, Avant	Est	ALT	08/01→01/05			4	4	U5013	48040
2.4	Sal	AGA, ALF, AML, APS, ARJ	05/97→08/01			1	5	U2010	48037
2.4	Sal	BDV	08/01→06/04			1	5	U2010	48037
2.4, Avant	Est	AGA, ALF, AML, APS, ARJ	02/98→08/01			1	5	U2010	48037
2.4, Avant	Est	BDV	08/01→01/05			1	5	U2010	48037
2.4, Avant Quattro	Est	AGA, ALF, AML, APS, ARJ	11/99→08/01			1	5	U2010	48037
2.4, Avant Quattro	Est	BDV	08/01→09/03			1	5	U2010	48037
2.4, Quattro	Sal	AGA, ALF, AML, APS, ARJ	11/99→08/01			1	5	U2010	48037
2.4, Quattro	Sal	BDV	08/01→09/03			1	5	U2010	48037
2.7, Avant Quattro	Est	AJK, AZA	06/99→08/01			1	3	U5004	48008
2.7, Avant Quattro	Est	ARE	08/01→06/02			6	3	U5004	48008
2.7, Avant Quattro	Est	BES	07/02→09/03			6	4	U5003	48005
2.7, Quattro	Sal	AJK	06/99→08/01			1	3	U5004	48008
2.7, Quattro	Sal	ARE	08/01→06/02			6	3	U5004	48008
2.7, Quattro	Sal	BES	07/02→09/03			6	4	U5003	48005
2.8	Sal	ACK, AOD, APR	05/97→06/99			1	5	U2010	48037
2.8, Avant	Est	ACK, AOD, APR	12/97→06/99			1	5	U2010	48037
2.8, Avant Quattro	Est	ACK, ALG, AMX, APR, AOD	12/97→08/01			1	5	U2010	48037
2.8, Quattro	Sal	ACK, ALG, AMX, APR, AOD	05/97→08/01			1	5	U2010	48037
3.0, Avant Quattro	Est	ASN	08/01→01/05			6	4	U5013	48040
3.0, Quattro	Sal	ASN	08/01→06/04			6	4	U5013	48040
4.2, Avant Quattro	Est	ARS, ASG, AWN	02/99→09/03			8	4	U5022	48082
4.2, Quattro	Sal	ARS, ASG, AWN	02/99→09/03			8	4	U5022	48082
A6 (04→12)									
2.0, TFSi	Sal	BPJ, BYK	07/05→12/08			4	4	U5015	48042
2.0, TFSi Avant	Est	BPJ	07/05→12/08			4	4	U5015	48042
2.4	Sal	BDW	06/04→10/08			6	4	U5014	48041
2.4, Avant	Est	BDW	04/05→10/08			6	4	U5014	48041
2.4, Quattro	Sal	BDW	10/05→10/08			6	4	U5014	48041
2.4, Quattro Avant	Est	BDW	05/05→10/08			6	4	U5014	48041
2.8, FSi	Sal	BDX	01/07→10/08			6	4	U5014	48041
2.8, FSi	Sal	CCEA	10/08→03/11			6	4	U5014	48041
2.8, FSi Avant	Est	BDX	01/07→10/08			6	4	U5014	48041
2.8, FSi Avant	Est	CCEA	10/08→08/11			6	4	U5014	48041
2.8, FSi Quattro	Sal	BDX	03/08→10/08			6	4	U5014	48041
2.8, FSi Quattro	Sal	CCEA	10/08→03/11			6	4	U5014	48041
2.8, FSi Quattro Avant	Est	BDX	03/08→10/08			6	4	U5014	48041
2.8, FSi Quattro Avant	Est	CCEA	10/08→08/11			6	4	U5014	48041
3.0, ALLROAD TFSI	Est	CAJA	01/09→03/12			6	4	U5014	48041
3.0, TFSI Quattro	Sal	CAJA	10/08→03/11			6	4	U5014	48041
3.2 FSi	Sal	AUK	06/04→03/09	To Ch. No.: 4F-7-015 229		6	4	U5014	48041
3.2 FSi Avant	Est	AUK	06/05→10/08	To Ch. No.: 4F-7-015 229		6	4	U5014	48041
3.2 FSi Quattro	Sal	AUK	06/04→10/08	To Ch. No.: 4F-7-015 229		6	4	U5014	48041
3.2 FSi Quattro Avant	Est	AUK	04/05→10/08	To Ch. No.: 4F-7-015 229		6	4	U5014	48041
4.2, Quattro	Sal	BAT	06/04→05/06			8	4	U5024	48088
4.2, Quattro	Sal	BVJ	07/06→03/09			8	4	U5014	48041
4.2, Quattro Avant	Est	BAT	04/05→05/06			8	4	U5024	48088
4.2, Quattro Avant	Est	BVJ	07/06→03/09			8	4	U5014	48041
A6 (11→)									
3.0, Allroad TFSI		CGWD	03/12→			6	4	U5014	48041
3.0, TFSI 300 Quattro Avant		CGWB	06/11→08/12			6	4	U5014	48041
3.0, TFSI 310 Quattro Avant		CGWD	02/12→			6	4	U5014	48041
A7 (10→)									
2.8, FSi Quattro		CHVA, CNYA	10/10→			6	4	U5014	48041

LITRE / MODEL	BODY	ENGINE TYPE	DATE	ADDITIONAL INFORMATION	FITMENT INFORMATION	NO. OF COILS	NO. OF PINS	PART NO.	STOCK NO.
AUDI (continued)									
A7 (10→)									
3.0, TFSI Quattro		CGWB	10/10→08/12			6	4	U5014	48041
3.0, TFSI Quattro		CGWD, CGXB, CTTA, CTUA	02/12→			6	4	U5014	48041
A8 (94→03)									
2.8		AAH	10/94→03/96	With Bracket		1	6	U2013	48049
2.8		ACK, ALG, AMX, APR, AQD	09/96→12/00			1	5	U2010	48037
2.8, Quattro		ACK, AMX, APR, AQD	10/00→09/02			1	5	U2010	48037
3.7, Quattro		AKC, AQG	03/99→09/02			8	4	U5022	48082
4.2, Quattro		ABZ, AKG	10/94→11/98	To Ch. No.: 4D..T..000 220		8	4	U5022	48082
4.2, Quattro		AQF, AUW, AUX	03/99→09/02			8	4	U5022	48082
A8 (03→10)									
2.8, FSi		BDX	08/07→07/10			6	4	U5014	48041
3.0		ASN	01/04→05/05			6	4	U5013	48040
3.0, LWB		ASN	01/04→05/05			6	4	U5013	48040
3.2 FSi		BPK	09/05→07/10			6	4	U5014	48041
3.2 FSi LWB		BPK	09/05→07/10			6	4	U5014	48041
3.2 FSi Quattro		BPK	09/05→07/10			6	4	U5014	48041
3.7, Quattro		BFL	05/03→05/06			8	4	U5024	48088
4.2, Quattro		BFM	05/03→02/07			8	4	U5024	48088
4.2, Quattro		BVJ	03/07→07/10			8	4	U5014	48041
4.2, Quattro LWB		BFM	02/04→02/07			8	4	U5024	48088
4.2, Quattro LWB		BVJ	03/07→07/10			8	4	U5014	48041
6.0, W12		BHT, BSB, BTE	04/04→12/06			12	4	U5017	48047
6.0, W12 LWB		BHT, BSB, BTE	02/04→07/10			12	4	U5017	48047
A8 (10→)									
3.0, TFSI Quattro		CGWA, CGXA	07/10→			6	4	U5014	48041
4.2, FSi Quattro		CDRA	03/10→03/12			8	4	U5014	48041
Allroad (97→05)									
2.7		ARE	05/00→06/02			6	3	U5004	48008
2.7		BES	07/02→08/05			6	4	U5003	48005
Allroad (04→12)									
3.0, TFSI		CAJA	10/08→06/09			6	4	U5014	48041
3.2 FSi		AUK	02/07→06/09	To Ch. No.: 4F-7-015 229		6	4	U5014	48041
4.2		BVJ	02/07→06/09			8	4	U5014	48041
Cabriolet (92→00)									
1.8		ADR	01/97→08/00		Incl. Control Unit	1	3	U6037	48048
2.0		ABK	07/93→12/96		Incl. Control Unit, For Vehicles With Distributor	1	3	U1001	48000
2.6		ABC	05/94→09/99			1	5	U2010	48037
2.8		AAH	05/96→08/00			1	5	U2010	48037
Convertible (97→99)									
1.8		ADR	10/97→09/99		Incl. Control Unit	1	3	U6037	48048
2.6		ABC	10/97→09/99			1	5	U2010	48037
2.8		AAH	10/97→09/99			1	5	U2010	48037
Coupe (81→88)									
1.8, Carburettor		DS, JV	10/84→07/86			1	2	U1081	48344
1.8, Injection		DZ	08/86→01/88			1	2	U1081	48344
2.0		HP, JS	09/83→07/86			1	2	U1081	48344
2.2		HY, KV	04/86→09/87	From Ch. No.: 85-G-000001		1	2	U1081	48344
Coupe (88→92)									
2.0		3A, AAD, ABK	09/89→10/92		Incl. Control Unit, For Vehicles With Distributor	1	3	U1001	48000
2.2, Quattro		KV	11/88→09/89			1	2	U1081	48344
2.3, Quattro		NG	09/89→12/91			1	2	U1081	48344
Coupe (91→96)									
2.0		AAH, ABK	11/94→12/95		Incl. Control Unit, For Vehicles With Distributor	1	3	U1001	48000
2.6		ABC	09/92→09/96			1	5	U2010	48037

LITRE / MODEL	BODY	ENGINE TYPE	DATE	ADDITIONAL INFORMATION	FITMENT INFORMATION	NO. OF COILS	NO. OF PINS	PART NO.	STOCK NO.
AUDI (continued)									
Coupe (91→96)									
2.8, Quattro		AAH	10/91→12/95			1	5	U2010	48037
Q3 (11→)									
2.0, TFSI 170 Quattro		CCZC	07/11→			4	4	U5015	48042
2.0, TFSI 211 Quattro		CPSA	07/11→			4	4	U5015	48042
Q5 (08→12)									
2.0, TFSI 180		CDNB, CNCB	12/09→10/12			4	4	U5015	48042
2.0, TFSI 211		CAEB, CDNC, CPMA	11/08→10/12			4	4	U5015	48042
3.2, FSI		CALB	04/09→10/12			6	4	U5015	48042
Q5 (12→)									
2.0, TFSI		CDNB, CNCB	10/12→			4	4	U5015	48042
3.0, TFSI		CTUC, CTVA	06/12→			6	4	U5014	48041
Q7 (06→)									
3.0, TFSI 272		CJTC, CJWC	05/10→			6	4	U5014	48041
3.0, TFSI 333		CJTB, CJWB, CNA, CTWA	05/10→			6	4	U5014	48041
3.6, FSi		BHK	01/07→05/10	To Ch. No.: 4L-7-057 000		6	4	U5020	48065
4.2		BAR	05/06→05/10			8	4	U5014	48041
Quattro (80→91)									
2.1		GV, WR	11/80→07/87		For Vehicles With Distributor	1	2	U1076	48339
2.2		1B, MB	12/87→07/89		Incl. Control Unit, For Vehicles With Distributor	1	3	U1001	48000
2.2		RR	08/89→04/91		Incl. Control Unit, For Vehicles With Distributor	1	3	U1001	48000
R8 (07→13)									
4.2	Cpe	BYH	07/07→09/10			8	4	U5014	48041
4.2, FSI	Cpe	CNDA	07/10→05/13			8	4	U5014	48041
4.2, FSI Spyder	Cnv	CNDA	10/10→05/13			8	4	U5014	48041
5.2	Cpe	BUJ	04/09→05/12			10	4	U5014	48041
5.2, GT	Cpe	CMPA	03/11→05/13			10	4	U5015	48042
5.2, GT Spyder	Cnv	CMPA	11/11→05/13			10	4	U5015	48042
5.2, Spyder	Cnv	BUJ	02/10→05/12			10	4	U5014	48041
R8 (12→)									
4.2	Cpe	CNDA	12/12→			8	4	U5014	48041
4.2, Spyder	Cnv	CNDA	12/12→			8	4	U5014	48041
5.2	Cpe	CTPA	12/12→			10	4	U5014	48041
5.2, Plus	Cpe	CTPA	12/12→			10	4	U5014	48041
5.2, Spyder	Cnv	CTPA	12/12→			10	4	U5014	48041
RS3 (11→)									
2.5		CEPA	04/11→04/13			5	4	U5015	48042
RS4 (95→01)									
2.7, Avant Quattro		ASJ, AZR	05/00→09/01			6	3	U5004	48008
4.2	Cnv	BNS	09/06→12/08			8	4	U5015	48042
4.2	Sal	BNS	10/05→12/07			8	4	U5015	48042
4.2, Avant Quattro	Est	BNS	09/06→06/08			8	4	U5015	48042
RS4 (11→)									
4.2, Avant Quattro		CFSA	07/12→			8	4	U5015	48042
RS5 (07→)									
4.2, Quattro		CFSA	03/10→			8	4	U5015	48042
RS6 (97→05)									
4.2, Avant Plus Quattro	Est	BRV	06/04→01/05			8	4	U5022	48082
4.2, Avant Quattro	Est	BCY	09/02→01/05			8	4	U5022	48082
4.2, Quattro	Sal	BCY	09/02→06/04			8	4	U5022	48082
RS6 (04→12)									
5.0, Avant Quattro	Est	BUH	04/08→08/10			10	4	U5014	48041
5.0, Quattro	Sal	BUH	09/08→08/10			10	4	U5014	48041
S3 (96→03)									
1.8, Quattro		APY, AMK	05/99→10/01	From Ch. No.: 8LY200000		4	4	U5022	48082

LITRE / MODEL	BODY	ENGINE TYPE	DATE	ADDITIONAL INFORMATION	FITMENT INFORMATION	NO. OF COILS	NO. OF PINS	PART NO.	STOCK NO.
AUDI (continued)									
S3 (96→03)									
1.8, Quattro		AUL, AMK	05/99→10/01	From Ch. No.: 8L1000001		4	4	U5003	48005
1.8, Quattro		BAM	10/01→08/03			4	4	U5003	48005
S3 (03→)									
2.0, TFSi Quattro		BHZ, CDLA	11/06→			4	4	U5015	48042
S4 (95→01)									
2.7, Avant Quattro	Est	AGB, AZB	08/98→06/01			6	3	U5004	48008
2.7, Quattro	Sal	AGB, AZB	08/98→11/00			6	3	U5004	48008
S4 (01→04)									
4.2, Avant Quattro	Est	BBK	08/03→12/04			8	4	U5024	48088
4.2, Quattro	Cnv	BBK	03/04→03/05			8	4	U5024	48088
4.2, Quattro	Sal	BBK	08/03→12/04			8	4	U5024	48088
S4 (04→08)									
4.2, Quattro	Sal	BBK, BHF	11/04→06/08			8	4	U5024	48088
4.2, Quattro Avant	Est	BBK	11/04→06/08			8	4	U5024	48088
S4 (06→10)									
4.2, Quattro		BBK	03/05→03/09			8	4	U5024	48088
S4 (08→12)									
3.0, Avant Quattro	Est	CAKA, CGWC	03/09→05/12			6	4	U5014	48041
3.0, Quattro	Sal	CAKA, CCBA, CGWC, CGXC	03/09→05/12			6	4	U5014	48041
S4 (11→)									
3.0, Avant Quattro	Est	CAKA, CGWC	12/11→			6	4	U5014	48041
3.0, Quattro	Sal	CAKA, CCBA, CGWC, CGXC	12/11→			6	4	U5014	48041
S5 (07→)									
3.0, Quattro	Cnv	CAKA, CCBA	06/09→			6	4	U5014	48041
3.0, Quattro	Cpe	CAKA, CGWC	10/11→			6	4	U5014	48041
3.0, Quattro	Hbk	CAKA, CGWC	01/10→			6	4	U5014	48041
4.2, Quattro	Cpe	CAUA	07/07→03/12			8	4	U5014	48041
S6 (97→05)									
4.2	Sal	ANK, AQJ	09/99→06/04			8	4	U5022	48082
4.2, Avant	Est	ANK, AQJ	09/99→12/04			8	4	U5022	48082
S6 (04→12)									
5.2	Sal	BXA	06/06→03/11			10	4	U5014	48041
5.2, Avant	Est	BXA	06/06→08/11			10	4	U5014	48041
S8 (94→03)									
4.2, Quattro		AHC, AKH	09/97→02/99			8	3	U5004	48008
4.2, Quattro		AQH, AVP	06/99→09/02			8	4	U5022	48082
S8 (03→10)									
5.2, FSi Quattro		BSM	06/06→07/10			10	4	U5014	48041
TT (99→06)									
1.8	Cnv	AJQ	02/00→10/05	To Ch. No.: 8N..1..010 000		4	4	U5022	48082
1.8	Cnv	APX, BAM	10/99→10/05			4	4	U5003	48005
1.8	Cnv	APX, BAM	10/99→10/05			4	4	U5022	48082
1.8	Cnv	ARY, AWP	02/00→10/05			4	4	U5003	48005
1.8	Cnv	AUM	03/03→10/05	From Ch. No.: 8N..1..010 001		4	4	U5003	48005
1.8	Cnv	AUM	03/03→10/05	To Ch. No.: 8N..1..010 000		4	4	U5022	48082
1.8	Cnv	BVP	10/05→06/06			4	4	U5003	48005
1.8	Cnv, Cpe	BVR	10/05→06/06			4	4	U5003	48005
1.8	Cpe	AJQ	02/99→10/05	To Ch. No.: 8N..1..010 000		4	4	U5022	48082
1.8	Cpe	APX, BAM	02/99→10/05	From Ch. No.: 8N1010001	Bremi	4	4	U5003	48005
1.8	Cpe	APX, BAM	09/00→10/05	To Ch. No.: 8N1010000	Hitachi	4	4	U5022	48082
1.8	Cpe	ARY	02/99→10/05			4	4	U5003	48005
1.8	Cpe	BAM	01/03→10/05	From Ch. No.: 8N1010001		4	4	U5003	48005
1.8, Sport	Cpe	BFV	10/05→06/06			4	4	U5003	48005
3.2	Cnv	BHE, BPF	11/03→06/06			6	4	U5020	48065
3.2	Cpe	BHE, BPF	09/03→06/06			6	4	U5020	48065

LITRE / MODEL	BODY	ENGINE TYPE	DATE	ADDITIONAL INFORMATION	FITMENT INFORMATION	NO. OF COILS	NO. OF PINS	PART NO.	STOCK NO.
AUDI (continued)									
TT (06→15)									
1.8, TFSI	Cnv	CDAA	03/09→			4	4	U5014	48041
1.8, TFSI	Cnv	CDAA	03/09→			4	4	U5015	48042
1.8, TFSI	Cpe	CDAA	09/11→			4	4	U5014	48041
1.8, TFSI	Cpe	CDAA	09/11→			4	4	U5015	48042
2.0, TFSI 200	Cnv	BPY, BWA, CCTA	03/07→06/10			4	4	U5015	48042
2.0, TFSI 200	Cpe	BPY, BWA, CCTA	09/06→06/10			4	4	U5015	48042
2.0, TFSI 200 Quattro	Cnv, Cpe	CCZA	03/09→06/10			4	4	U5015	48042
2.0, TFSI 211	Cnv, Cpe	CESA	05/10→			4	4	U5015	48042
2.0, TFSI 211 Quattro	Cnv, Cpe	CESA, CETA	05/10→			4	4	U5015	48042
2.0, TT S	Cnv, Cpe	CDLB	05/08→			4	4	U5015	48042
2.5, TT RS	Cnv, Cpe	CEPA	07/09→			5	4	U5015	48042
2.5, TT RS Plus	Cnv	CEPB	04/12→			5	4	U5015	48042
2.5, TT RS Plus	Cpe	CEPB	07/12→			5	4	U5015	48042
3.2	Cnv	BUB	03/07→06/10			6	4	U5020	48065
3.2	Cpe	BUB	09/06→06/10			6	4	U5020	48065

AUSTIN/MORRIS (SEE ALSO ROVER)									
Allegro (73→83)									
1.1	Sal	10H	01/80→10/81		For Vehicles With Distributor	1	2	U1079	48342
1.3	Est	12L	01/80→12/83		For Vehicles With Distributor	1	2	U1079	48342
Ambassador (82→84)									
1.7		17HL	03/82→02/84		For Vehicles With Distributor	1	2	U1056	48236
2.0, HLS			03/82→07/84		For Vehicles With Distributor	1	2	U1056	48236
2.0, L/HL		20H	03/82→07/84		For Vehicles With Distributor	1	2	U1056	48236
Ital MK 1 (80→82)									
1.3	Est, Sal		07/80→09/82		For Vehicles With Distributor	1	2	U1056	48236
1.7	Est, Sal		07/80→09/82		For Vehicles With Distributor	1	2	U1056	48236
2.0	Est, Sal		07/80→12/82		For Vehicles With Distributor	1	2	U1056	48236
Ital MK 2 (82→84)									
1.3	Est, Sal		09/82→03/84		For Vehicles With Distributor	1	2	U1056	48236
1.7	Est, Sal		09/82→03/84		For Vehicles With Distributor	1	2	U1056	48236
Maestro (83→94)									
1.3		12H, 12HE	03/83→12/92		For Vehicles With Distributor	1	2	U1076	48339
1.3, HLE/LE (Economy tuned)		12H	03/83→04/87		For Vehicles With Distributor	1	2	U1076	48339
1.3, With Catalyst		12HE	09/92→12/94		For Vehicles With Distributor	1	2	U1076	48339
1.6		16HC37	03/83→07/92		For Vehicles With Distributor	1	2	U1076	48339
Marina (72→80)									
1.3	Est, Sal		01/80→10/80		For Vehicles With Distributor	1	2	U1056	48236
1.3	Est, Sal		01/80→10/80		For Vehicles With Distributor	1	2	U1079	48342
Maxi MK 1 (69→80)									
1.5		14H	01/80→07/80		For Vehicles With Distributor	1	2	U1079	48342
1.7, 1750 HLS		17LA	01/80→08/80		For Vehicles With Distributor	1	2	U1079	48342
1.7, 1750 L/HL		17H	01/80→08/80		For Vehicles With Distributor	1	2	U1079	48342
Metro (80→90)									
1.0, High compression engine		99H	10/80→04/90		For Vehicles With Distributor	1	2	U1056	48236
1.0, Low compression engine		99H	10/80→04/90		For Vehicles With Distributor	1	2	U1056	48236
1.3		12H, 12HL	10/80→09/84		For Vehicles With Distributor	1	2	U1056	48236
1.3		12H, 12HL	10/84→04/90		For Vehicles With Distributor	1	2	U1076	48339
Mini									
0.8, 850	Sal	BMCSerieA	08/69→08/79		For Vehicles With Distributor	1	2	U1079	48342
0.8, MK 1	Sal	BMCSerieA	01/67→12/67		For Vehicles With Distributor	1	2	U1061	48298
0.8, MK 1 Countryman	Est	BMCSerieA	01/67→12/67		For Vehicles With Distributor	1	2	U1061	48298
0.8, MK 2 850		BMCSerieA	10/67→01/69		For Vehicles With Distributor	1	2	U1061	48298
0.8, MK 2 850		BMCSerieA	01/69→12/69		For Vehicles With Distributor	1	2	U1079	48342

LITRE / MODEL	BODY	ENGINE TYPE	DATE	ADDITIONAL INFORMATION	FITMENT INFORMATION	NO. OF COILS	NO. OF PINS	PART NO.	STOCK NO.
AUSTIN/MORRIS (SEE ALSO ROVER) (continued)									
Mini									
0.8, Morris Mini Minor	Sal	BMCSerieA	01/67→12/67		For Vehicles With Distributor	1	2	U1061	48298
0.8, Morris Mini Minor Traveller	Est	BMCSerieA	01/67→12/67		For Vehicles With Distributor	1	2	U1061	48298
1.0	Sal	99H997P, 99HA53P, 99HC20P	08/82→12/92		For Vehicles With Distributor	1	2	U1056	48236
1.0	Sal	99H997P, 99HA53P, 99HC20P	08/82→12/92		For Vehicles With Distributor	1	2	U1079	48342
1.1, Clubman Manual	Est	10H	01/76→08/81		For Vehicles With Distributor	1	2	U1079	48342
1.1, Clubman Manual	Sal	10H	01/76→12/80		For Vehicles With Distributor	1	2	U1079	48342
1.3, Cooper S 1275cc	Sal		02/64→12/67		For Vehicles With Distributor	1	2	U1079	48342
1.3, MK 2 Cooper S 1275cc			10/67→08/69		For Vehicles With Distributor	1	2	U1079	48342
Minor Series 3									
0.9, Morris Minor 1000	Sal		10/56→12/61		For Vehicles With Distributor	1	2	U1061	48298
0.9, Morris Minor 1000 Pickup	Pck		10/56→12/62		For Vehicles With Distributor	1	2	U1061	48298
0.9, Morris Minor 1000 Tourer	Cnv		10/56→12/62		For Vehicles With Distributor	1	2	U1061	48298
0.9, Morris Minor 1000 Traveller	Est		10/56→12/61		For Vehicles With Distributor	1	2	U1061	48298
0.9, Morris Minor 1000 Van	Van		10/56→12/62		For Vehicles With Distributor	1	2	U1061	48298
Minor Series 5									
1.1, Morris Minor 1000	Sal		10/62→12/70		For Vehicles With Distributor	1	2	U1079	48342
1.1, Morris Minor 1000 Pickup	Pck		10/62→10/71		For Vehicles With Distributor	1	2	U1079	48342
1.1, Morris Minor 1000 Tourer	Cnv		10/62→08/69		For Vehicles With Distributor	1	2	U1079	48342
1.1, Morris Minor 1000 Traveller	Est		10/62→10/71		For Vehicles With Distributor	1	2	U1079	48342
1.1, Morris Minor 1000 Van	Van		10/62→12/72		For Vehicles With Distributor	1	2	U1079	48342
Montego (84→94)									
1.3	Sal	12HL	10/84→08/88		For Vehicles With Distributor	1	2	U1076	48339
1.6	Est	16HC37, 16HL	10/84→08/88		For Vehicles With Distributor	1	2	U1076	48339
1.6	Est	16HC37, 16HL	10/90→09/92		For Vehicles With Distributor	1	2	U1076	48339
1.6	Sal	16HC37, 16HL	04/84→08/88		For Vehicles With Distributor	1	2	U1076	48339
2.0, Carburettor	Est	20H, 20HSC	10/84→08/91		For Vehicles With Distributor	1	2	U1076	48339
2.0, Carburettor	Sal	20H, 20HSC	04/84→08/88		For Vehicles With Distributor	1	2	U1076	48339
2.0, Injection	Est	20H	02/85→08/88		For Vehicles With Distributor	1	2	U1076	48339
2.0, Injection	Sal	20H	02/87→09/90		For Vehicles With Distributor	1	2	U1076	48339
2.0, Injection	Sal		02/85→10/88		For Vehicles With Distributor	1	2	U1076	48339
2.0, Injection (with catalyst)	Est	20H, 20HSC	01/91→08/91		For Vehicles With Distributor	1	2	U1076	48339
2.0, Injection (with catalyst)	Sal	20H	01/91→07/93		For Vehicles With Distributor	1	2	U1076	48339
2.0, MG Turbo	Sal	20HC85, 20HT	04/85→09/90		For Vehicles With Distributor	1	2	U1076	48339
Princess (75→82)									
2.0		20H	01/80→10/82		For Vehicles With Distributor	1	2	U1056	48236

BENTLEY									
Continental									
6.0, Flying Spur	Sal	MTBHT	05/05→			12	4	U5017	48047
6.0, Flying Spur Speed	Sal		09/08→			12	4	U5017	48047
6.0, GT	Cpe		09/03→12/11			12	4	U5017	48047
6.0, GTC	Cnv	MTBHT	12/06→			12	4	U5017	48047
6.0, GTC Speed	Cnv	MTBHT	03/10→04/12			12	4	U5017	48047
6.0, GT Speed	Cpe		03/12→			12	4	U5017	48047
6.0, GT Speed	Cpe		09/07→03/11			12	4	U5017	48047
6.0, Supersports	Cnv		03/11→04/12			12	4	U5017	48047
6.0, Supersports	Cpe		03/10→			12	4	U5017	48047
6.0, Supersports ISR	Cnv		04/11→			12	4	U5017	48047

LITRE / MODEL	BODY	ENGINE TYPE	DATE	ADDITIONAL INFORMATION	FITMENT INFORMATION	NO. OF COILS	NO. OF PINS	PART NO.	STOCK NO.
BMW									
1 Series 116 E81									
1.6, i		N43B16A	02/07→10/07			4	3	U5039	48147
1.6, i		N45B16, N45B16A, N45B16TU2	02/07→10/07	Triangular Connector		4	3	U5055	48026
1.6, i			09/07→05/09			4	3	U5039	48147
2.0, i		N43B20A	01/09→07/12			4	3	U5039	48147
1 Series 116 E87									
1.6, i		N43B16A	09/04→05/09			4	3	U5039	48147
1.6, i		N45B16, N45B16A	09/04→06/09	Triangular Connector		4	3	U5055	48026
1.6, i		N45B16TU2	09/07→05/09	Triangular Connector		4	3	U5055	48026
2.0, i		N43B20B, N43B20A, N42B20B, N42B20A	01/09→07/12			4	3	U5039	48147
1 Series 118 E81									
2.0, i		N43B20A, N46B20B	04/07→07/12			4	3	U5039	48147
1 Series 118 E87									
2.0, i		N43B20A, N46B20B	02/05→03/07	Triangular Connector		4	3	U5055	48026
2.0, i		N43B20A, N46B20B	04/07→07/12			4	3	U5039	48147
1 Series 118 E88									
2.0, i		N43B20A	04/08→			4	3	U5039	48147
1 Series 120 E81									
2.0, i		N43B20A	04/07→12/10			4	3	U5039	48147
1 Series 120 E82									
2.0, i		N43B20A	10/09→			4	3	U5039	48147
1 Series 120 E87									
2.0, i		N43 B20A	09/04→12/10			4	3	U5039	48147
2.0, i		N42B20A, N46B20	09/04→03/07	Triangular Connector		4	3	U5055	48026
1 Series 120 E88									
2.0, i		N43B20A	04/08→			4	3	U5039	48147
1 Series 125 E82									
3.0, i		N53B30A	04/08→			6	3	U5055	48206
1 Series 125 E88									
3.0, i		N52B30A	04/08→			6	3	U5055	48206
1 Series 130 E81									
3.0, i		N52B30, N52B30A	02/07→10/07	Triangular Connector		6	3	U5058	48216
3.0, i		N52B30, N52B30A	11/07→05/10			6	3	U5055	48206
1 Series 130 E87									
3.0, i		N52B30, N52B30A	02/07→05/10	Triangular Connector		6	3	U5058	48216
3.0, i		N52B30, N52B30A	04/06→05/10			6	3	U5055	48206
3.0, i		N52B30, N52B30A	09/05→03/07			6	3	U5055	48206
1 Series 135 E82									
3.0, i		N54B30A, N55B30A	10/07→			6	3	U5055	48206
1 Series 135 E88									
3.0, i		N54B30A, N55B30A	04/08→			6	3	U5055	48206
1 Series M Coupe E82									
3.0		N54B30A	04/11→06/12			6	3	U5055	48206
3 Series 316 E21									
1.6			01/80→12/80		For Vehicles With Distributor	1	2	U1082	48345
1.8		M10B18	09/80→08/82		For Vehicles With Distributor	1	2	U1082	48345
3 Series 316 E30									
1.6, i	Sal	M40B16	09/88→06/91		For Vehicles With Distributor	1	2	U1082	48345
1.6, i Touring	Est	M40B16	09/91→06/94			1	6	U2030	48133
1.8	Sal	M10B18	03/83→09/88		For Vehicles With Distributor	1	2	U1082	48345
1.8, Baur cabriolet	Cnv		01/84→09/88		For Vehicles With Distributor	1	2	U1082	48345
3 Series 316 E36									
1.6, i	Cpe	M43B16	01/94→04/99			1	6	U2030	48133
1.6, i	Sal	M40B16, M43B16	09/93→02/98			1	6	U2030	48133
1.6, i Compact	Hbk	M43B16	09/94→01/99			1	6	U2030	48133
1.6, i Touring	Est	M43B16	04/97→10/99			1	6	U2030	48133

LITRE / MODEL	BODY	ENGINE TYPE	DATE	ADDITIONAL INFORMATION	FITMENT INFORMATION	NO. OF COILS	NO. OF PINS	PART NO.	STOCK NO.
BMW (continued)									
3 Series 316 E36									
1.9, i Compact	Hbk	M43164E3, M43B19TU	01/99→08/00			1	6	U2030	48133
3 Series 316 E46									
1.8, i	Sal	N42B18, N46B18, N46B18A	02/02→02/05	Triangular Connector		4	3	U5055	48026
1.8, i Touring	Est	N42B18, N46B18, N46B18A	03/02→02/05	Triangular Connector		4	3	U5055	48026
1.8, ti Compact	Hbk	N42B18, N46B18A	09/01→02/05	Triangular Connector		4	3	U5055	48026
1.9, i	Sal	M43164E3, M43B19TU	03/99→01/02			1	6	U2030	48133
3 Series 318 E30									
1.8, i	Cnv	M40B18	01/91→07/93		For Vehicles With Distributor	1	2	U1082	48345
1.8, i	Sal	M10B18	09/83→08/87		For Vehicles With Distributor	1	2	U1082	48345
1.8, i	Sal	M40B18	10/87→06/91		For Vehicles With Distributor	1	2	U1082	48345
1.8, i Baur cabriolet	Cnv		09/83→10/87		For Vehicles With Distributor	1	2	U1082	48345
1.8, i Touring	Est	M40B18	04/89→06/91			1	6	U2030	48133
1.8, iS	Sal	M42B18	06/90→07/91			4	3	U5012	48036
3 Series 318 E36									
1.8, i	Cnv	M43B18	05/94→04/99			1	6	U2030	48133
1.8, i	Sal	M40B18	04/91→10/93			1	6	U2030	48133
1.8, i	Sal	M43B18	01/94→02/98			1	6	U2030	48133
1.8, i Touring	Est	M43B18	01/96→10/99			1	6	U2030	48133
1.8, iS	Cpe	M42B18	04/92→09/93			4	3	U5012	48036
1.8, iS	Cpe	M42B18	10/93→10/95			1	6	U2030	48133
1.8, ti Compact	Hbk	M42B18	11/94→08/95			1	6	U2030	48133
1.9, iS	Cpe	M44B19	09/95→04/99			1	6	U2030	48133
1.9, iS	Sal		02/98→03/99			1	6	U2030	48133
1.9, ti Compact	Hbk	M44B19	04/96→08/00			1	6	U2030	48133
3 Series 318 E46									
1.9, Ci	Cpe	M43B19	11/99→09/01			1	6	U2030	48133
1.9, i	Sal	M43B19, M43B19TU	09/98→09/01			1	6	U2030	48133
1.9, i Touring	Est	M43B19, M43B19TU	10/99→09/01			1	6	U2030	48133
2.0, Ci	Cnv, Cpe	N42B20, N46B20	09/01→03/04	Triangular Connector		4	3	U5055	48026
2.0, i	Sal	N42B20, N46B20, N46B20A	09/01→02/05	Triangular Connector		4	3	U5055	48026
2.0, i Touring	Est	N42B20, N46B20, N46B20A	09/01→02/05	Triangular Connector		4	3	U5055	48026
2.0, ti Compact	Hbk	N42B20, N46B20A	09/01→02/05	Triangular Connector		4	3	U5055	48026
3 Series 318 E90									
2.0, i		N43B20A	09/07→07/12			4	3	U5039	48147
2.0, i		N46B20, N46B20B	09/05→03/07	Triangular Connector		4	3	U5055	48026
3 Series 318 E91									
2.0, i Touring		N43B20A	09/07→			4	3	U5039	48147
2.0, i Touring		N46B20, N46B20B	04/06→09/07	Triangular Connector		4	3	U5055	48026
3 Series 318 E92									
2.0, i		N43B20A	02/11→			4	3	U5039	48147
3 Series 320 E21									
2.0		M20B20	01/80→08/82		For Vehicles With Distributor	1	2	U1065	48302
3 Series 320 E30									
2.0, i		M20B20	03/83→12/85		For Vehicles With Distributor	1	2	U1082	48345
3 Series 320 E36									
2.0, i	Cnv	M50B(206S2)Vanos, M50B20TU, M50B20	05/94→12/95			6	3	U5012	48036
2.0, i	Cnv	M50B(206S2)Vanos, M50B20TU, M50B20, M52B(206S3)Vanos	05/94→01/97			6	3	U5005	48009
2.0, i	Cpe	M50B(206S1), M50B(206S2)Vanos, M50B20TU	04/92→09/95			6	3	U5012	48036
2.0, i	Cpe	M52B(206S3)Vanos	09/94→09/95			6	3	U5005	48009
2.0, i	Sal	M50B(206S1), M50B(206S2)Vanos, M50B20, M50B20TU, M52B(206S3)Vanos, M52B20	01/96→09/96			6	3	U5005	48009

LITRE / MODEL	BODY	ENGINE TYPE	DATE	ADDITIONAL INFORMATION	FITMENT INFORMATION	NO. OF COILS	NO. OF PINS	PART NO.	STOCK NO.
BMW (continued)									
3 Series 320 E36									
2.0, i	Sal	M50B(206S1), M50B(206S2)Vanos, M50B20, M50B20TU, M52B(206S3)Vanos, M52B20	04/91→12/95			6	3	U5012	48036
2.0, i Touring	Est	M50B20, M50B20TU, M52B(206S3)Vanos, M52B20	03/95→01/97			6	3	U5005	48009
3 Series 320 E46									
2.2, Ci	Cnv	M54226S1, M54B22	10/02→08/06	Triangular Connector		6	3	U5055	48026
2.2, Ci	Cnv, Cpe	M54226S1, M54B22	09/00→09/02			6	3	U5005	48009
2.2, Ci	Cpe	M54226S1, M54B22	10/02→05/06	Triangular Connector		6	3	U5055	48026
2.2, i	Sal	M54226S1, M54B22	09/00→09/02			6	3	U5005	48009
2.2, i	Sal	M54226S1, M54B22	10/02→02/05	Triangular Connector		6	3	U5055	48026
2.2, i Touring	Est	M54226S1, M54B22	09/00→09/02			6	3	U5005	48009
2.2, i Touring	Est	M54226S1, M54B22	10/02→02/05	Triangular Connector		6	3	U5055	48026
3 Series 320 E90									
2.0, i		N43B20A	09/07→07/12			4	3	U5039	48147
2.0, i		N46B20, N46B20A, N46B20C	03/05→03/07	Triangular Connector		4	3	U5055	48026
2.0, si		N45B20A	05/06→10/06	Triangular Connector		4	3	U5055	48026
3 Series 320 E91									
2.0, i Touring		N43B20A	09/07→			4	3	U5039	48147
2.0, i Touring		N46B20, N46B20A, N46B20C	09/05→09/07	Triangular Connector		4	3	U5055	48026
3 Series 320 E92									
2.0, i		N43B20A	03/07→			4	3	U5039	48147
3 Series 320 E93									
2.0, i		N43B20A	03/07→			4	3	U5039	48147
3 Series 323 E21									
2.3, i		M20B23	01/80→08/82		For Vehicles With Distributor	1	2	U1082	48345
3 Series 323 E30									
2.3, i		M20B23	03/83→07/85		For Vehicles With Distributor	1	2	U1082	48345
3 Series 323 E36									
2.5, i	Cnv	M52B25(Vanos)	01/97→04/99			6	3	U5005	48009
2.5, i	Cpe	M52B25(Vanos)	03/95→04/99			6	3	U5005	48009
2.5, i	Sal	M52B25(Vanos)	09/96→02/98			6	3	U5005	48009
2.5, i Touring	Est	M52B25(Vanos)	01/97→10/99			6	3	U5005	48009
3 Series 323 E46									
2.5, Ci	Cnv	M52B25(Vanos)	05/00→09/00			6	3	U5005	48009
2.5, Ci	Cpe	M52B25(Vanos)	04/99→09/00			6	3	U5005	48009
2.5, i	Sal	M52B25(Vanos), M52B25TU	09/98→09/00			6	3	U5005	48009
3 Series 325 E36									
2.5, i	Cnv	M50B25, M50B25TU	07/93→03/95			6	3	U5012	48036
2.5, i	Cpe	M50B25, M50B25(Vanos), M50B25TU	04/92→09/95			6	3	U5012	48036
2.5, i	Sal	M50B25, M50B25(Vanos), M50B25TU	04/91→09/95			6	3	U5012	48036
3 Series 325 E46									
2.5, Ci	Cnv	M54256S5	10/02→08/06	Triangular Connector		6	3	U5055	48026
2.5, Ci	Cnv, Cpe	M54256S5	09/00→09/02			6	3	U5005	48009
2.5, Ci	Cpe	M54256S5	10/02→05/06	Triangular Connector		6	3	U5055	48026
2.5, i	Sal	M54256S5, M54B25	09/00→09/02			6	3	U5005	48009
2.5, i	Sal	M54256S5, M54B25	10/02→02/05	Triangular Connector		6	3	U5055	48026
2.5, i Touring	Est	M54256S5, M54B25	09/00→09/02			6	3	U5005	48009
2.5, i Touring	Est	M54256S5, M54B25	10/02→02/05	Triangular Connector		6	3	U5055	48026
2.5, ti Compact	Hbk	M54256S5, M54B25	09/01→09/02			6	3	U5005	48009
2.5, ti Compact	Hbk	M54256S5, M54B25	10/02→02/05	Triangular Connector		6	3	U5055	48026
3 Series 325 E90									
2.5, i		N52B25, N52B25A	03/05→04/06	Triangular Connector		6	3	U5058	48216
2.5, i		N52B25, N52B25A	05/06→12/07			6	3	U5055	48206
3.0, i		N53B30, N53B30A	09/07→07/12			6	3	U5039	48147

LITRE / MODEL	BODY	ENGINE TYPE	DATE	ADDITIONAL INFORMATION	FITMENT INFORMATION	NO. OF COILS	NO. OF PINS	PART NO.	STOCK NO.
BMW (continued)									
3 Series 325 E91									
2.5, i Touring		N52B25, N52B25A, N52B25C	04/06→12/07			6	3	U5055	48206
2.5, i Touring		N52B25, N52B25A, N52B25C	09/05→04/06	Triangular Connector		6	3	U5058	48216
3.0, i Touring		N53B30, N53B30A	09/07→			6	3	U5039	48147
3 Series 325 E92									
2.5, i		N52B25, N52B25A, N52B25C	09/06→12/07			6	3	U5055	48206
3.0, i		N53B30, N53B30A	09/07→			6	3	U5039	48147
3 Series 325 E93									
3.0, i		N53B30, N53B30A	03/07→			6	3	U5039	48147
3 Series 328 E36									
2.8, i	Cnv, Cpe	M52B28, M52B28TU	03/95→04/99			6	3	U5005	48009
2.8, i	Sal	M52B28, M52B28TU	03/95→02/98			6	3	U5005	48009
2.8, i Touring	Est	M52B28, M52B28TU	03/95→10/99			6	3	U5005	48009
3 Series 328 E46									
2.8, Ci	Cpe	M52B28	06/99→06/00			6	3	U5005	48009
2.8, i	Sal	M52B28	09/98→06/00			6	3	U5005	48009
2.8, i Touring	Est	M52B28	10/99→06/00			6	3	U5005	48009
3 Series 330 E46									
3.0, Ci	Cnv	M54306S3	10/02→08/06	Triangular Connector		6	3	U5055	48026
3.0, Ci	Cnv, Cpe	M54306S3	06/00→09/02			6	3	U5005	48009
3.0, Ci	Cpe	M54306S3	10/02→05/06	Triangular Connector		6	3	U5055	48026
3.0, i	Sal	M54306S3, M54B30	06/00→09/02			6	3	U5005	48009
3.0, i	Sal	M54306S3, M54B30	10/02→02/05	Triangular Connector		6	3	U5055	48026
3.0, i Touring	Est	M54306S3, M54B30	06/00→09/02			6	3	U5005	48009
3.0, i Touring	Est	M54306S3, M54B30	10/02→02/05	Triangular Connector		6	3	U5055	48026
3 Series 330 E90									
3.0, i		N52B30, N52B30A	03/05→04/06	Triangular Connector		6	3	U5058	48216
3.0, i		N52B30, N52B30A	05/06→09/07			6	3	U5055	48206
3.0, i		N53B30, N53B30A	09/07→12/10			6	3	U5039	48147
3 Series 330 E91									
3.0, i Touring		N52B30, N52B30A	04/06→09/07			6	3	U5055	48206
3.0, i Touring		N52B30, N52B30A	09/05→04/06	Triangular Connector		6	3	U5058	48216
3.0, i Touring		N53B30	09/07→12/10			6	3	U5039	48147
3 Series 330 E92									
3.0, i		N52B30A	09/06→			6	3	U5055	48206
3.0, i		N53B30, N53B30A	09/06→			6	3	U5039	48147
3 Series 330 E93									
3.0, i		N52B30A	03/07→			6	3	U5055	48206
3.0, i		N53B30, N53B30A	03/07→			6	3	U5039	48147
3 Series 335 E90									
3.0, i		N54B30A, N55B30A	11/06→07/12			6	3	U5055	48206
3 Series 335 E91									
3.0, i Touring		N54B30A	11/06→			6	3	U5055	48206
3 Series 335 E92									
3.0, i		N54B30A, N55B30A	09/06→			6	3	U5055	48206
3 Series 335 E93									
3.0, i		N54B30A, N54B30B, N55B30A	03/07→			6	3	U5055	48206
3 Series M3 E36									
3.0	Cnv	S50B30	07/94→09/95			6	3	U5012	48036
3.0	Cpe	S50B30	05/93→01/95			6	3	U5012	48036
3.2, Evolution	Cnv, Cpe	S50B32	03/96→04/99			6	3	U5005	48009
3.2, Evolution	Sal	S50B32	03/96→01/98			6	3	U5005	48009
3 Series M3 E46									
3.2	Cnv	S54326S4, S54B32	04/01→08/06	Triangular Connector		6	3	U5055	48026
3.2	Cpe	S54326S4, S54B32	10/00→05/06	Triangular Connector		6	3	U5055	48026
3.2, CS	Cpe	S54326S4, S54B32	04/05→05/06	Triangular Connector		6	3	U5055	48026
3.2, CSL	Cpe	S54B32, S54N326S4	08/03→12/03	Triangular Connector		6	3	U5055	48026

LITRE / MODEL	BODY	ENGINE TYPE	DATE	ADDITIONAL INFORMATION	FITMENT INFORMATION	NO. OF COILS	NO. OF PINS	PART NO.	STOCK NO.
BMW (continued)									
3 Series M3 E90									
4.0		S65B40	03/08→07/12			8	3	U5118	48338
3 Series M3 E92									
4.0			09/07→			8	3	U5118	48338
3 Series M3 E93									
4.0		S65B40	04/08→			8	3	U5118	48338
5 Series 518 E12									
1.8		M10B18	01/80→05/81		For Vehicles With Distributor	1	2	U1082	48345
5 Series 518 E28									
1.8		M10B18	10/81→08/84		For Vehicles With Distributor	1	2	U1082	48345
1.8, i		M10B18	01/85→10/87		For Vehicles With Distributor	1	2	U1082	48345
5 Series 518 E34									
1.8, i	Sal	M43B18	01/90→09/95			1	6	U2030	48133
1.8, i Touring	Est	M43B18	09/94→09/96			1	6	U2030	48133
5 Series 520 E12									
2.0		M20B20	01/80→05/81		For Vehicles With Distributor	1	2	U1065	48302
5 Series 520 E28									
2.0, i		M20B20	10/81→12/87		For Vehicles With Distributor	1	2	U1082	48345
5 Series 520 E34									
2.0, i	Sal	M20B20	06/88→09/90		Without CAT, With Distributor	1	2	U1082	48345
2.0, i	Sal	M50B(206S1), M50B(206S2)Vanos, M50B20, M50B20TU	09/90→09/95			6	3	U5012	48036
2.0, i Touring	Est	M50B(206S1), M50B(206S2)Vanos, M50B20, M50B20TU	03/92→09/96			6	3	U5012	48036
5 Series 520 E39									
2.0, i	Sal	M52B(206S3)Vanos, M52B(206S4), M52B20	04/96→09/00			6	3	U5005	48009
2.0, i Touring	Est	M52B(206S3)Vanos, M52B(206S4), M52B20	04/97→09/00			6	3	U5005	48009
2.2, i	Sal	M54B22	09/00→09/02			6	3	U5005	48009
2.2, i	Sal	M54B22	10/02→06/03	Triangular Connector		6	3	U5055	48026
2.2, i Touring	Est	M54B22	09/00→09/02			6	3	U5005	48009
2.2, i Touring	Est	M54B22	10/02→05/04	Triangular Connector		6	3	U5055	48026
5 Series 520 E60									
2.2, i		M54226S1, M54B22	08/03→04/05	Triangular Connector		6	3	U5055	48026
5 Series 523 E39									
2.5, i	Sal	M52B25(Vanos), M52B25TU	04/96→09/00			6	3	U5005	48009
2.5, i Touring	Est	M52B25(Vanos), M52B25TU	04/97→09/00			6	3	U5005	48009
5 Series 523 E60									
2.5, i		N52B25, N52B25A	07/05→02/07			6	3	U5055	48206
2.5, i		N52B25, N52B25A	07/05→02/07	Triangular Connector		6	3	U5058	48216
2.5, i		N52B25A	02/07→03/10			6	3	U5039	48147
5 Series 523 E61									
2.5, i Touring		N52B25, N52B25A	07/05→02/07			6	3	U5055	48206
2.5, i Touring		N52B25, N52B25A	07/05→02/07	Triangular Connector		6	3	U5058	48216
2.5, i Touring		N52B25A	02/07→03/11			6	3	U5039	48147
5 Series 523 F10									
3.0, i		N53B30A	03/10→12/11			6	3	U5039	48147
5 Series 523 F11									
3.0, i Touring		N53B30A	09/10→12/11			6	3	U5039	48147
5 Series 525 E12									
2.5		M30B25	01/80→05/81		For Vehicles With Distributor	1	2	U1065	48302
5 Series 525 E28									
2.5, i		M20B25E	10/81→10/87		For Vehicles With Distributor	1	2	U1082	48345
2.7, e		M20B27	06/83→12/87		For Vehicles With Distributor	1	2	U1082	48345

LITRE / MODEL	BODY	ENGINE TYPE	DATE	ADDITIONAL INFORMATION	FITMENT INFORMATION	NO. OF COILS	NO. OF PINS	PART NO.	STOCK NO.
BMW (continued)									
5 Series 525 E34									
2.5, i	Sal	M50B25, M50B25TU, M52B25(Vanos)	09/90→09/95			6	3	U5012	48036
2.5, i Touring	Est	M50B25, M50B25TU	03/92→09/96			6	3	U5012	48036
2.5, iX	Sal	M52B25(Vanos)	07/92→09/95			6	3	U5012	48036
2.5, iX Touring	Est	M50B25, M52B25(Vanos)	07/92→09/96			6	3	U5012	48036
5 Series 525 E39									
2.5, i	Sal	M54256S5, M54B25	09/00→09/02			6	3	U5005	48009
2.5, i	Sal	M54256S5, M54B25	10/02→06/03	Triangular Connector		6	3	U5055	48026
2.5, i Touring	Est	M54256S5, M54B25	09/00→09/02			6	3	U5005	48009
2.5, i Touring	Est	M54256S5, M54B25	10/02→05/04	Triangular Connector		6	3	U5055	48026
5 Series 525 E60									
2.5, i		M54256S5, M54B25	09/03→04/05	Triangular Connector		6	3	U5055	48026
2.5, i		N52B25, N52B25A	07/05→06/07			6	3	U5055	48206
2.5, i		N52B25, N52B25A	07/05→06/07	Triangular Connector		6	3	U5058	48216
3.0, i		N53B30, N53B30A	02/07→03/10			6	3	U5039	48147
5 Series 525 E61									
2.5, i Touring		M54256S5, M54B25	06/04→04/05	Triangular Connector		6	3	U5055	48026
2.5, i Touring		N52B25, N52B25A	07/05→06/07			6	3	U5055	48206
2.5, i Touring		N52B25, N52B25A	07/05→06/07	Triangular Connector		6	3	U5058	48216
3.0, i Touring		N53B30, N53B30A	02/07→03/11			6	3	U5039	48147
5 Series 528 E28									
2.8, i		M30B28	10/81→11/87		For Vehicles With Distributor	1	2	U1082	48345
5 Series 528 E39									
2.8, i	Sal	M52B28, M52B28TU	04/96→09/00			6	3	U5005	48009
2.8, i Touring	Est	M52B28, M52B28TU	01/97→09/00			6	3	U5005	48009
5 Series 528 F10									
3.0, i		N53B30A	03/10→12/11			6	3	U5039	48147
5 Series 528 F11									
3.0, i Touring		N53B30A	09/10→12/11			6	3	U5039	48147
5 Series 530 E34									
3.0, i	Sal	M60B30	01/93→09/95			8	3	U5012	48036
3.0, i Touring	Est	M60B30	01/93→09/96			8	3	U5012	48036
5 Series 530 E39									
3.0, i	Sal	M54306S3, M54B30	09/00→09/02			6	3	U5005	48009
3.0, i	Sal	M54306S3, M54B30	10/02→06/03	Triangular Connector		6	3	U5055	48026
3.0, i Touring	Est	M54306S3, M54B30	09/00→09/02			6	3	U5005	48009
3.0, i Touring	Est	M54306S3, M54B30	10/02→05/04	Triangular Connector		6	3	U5055	48026
5 Series 530 E60									
3.0, i		M54306S3, M54B30	08/03→04/05	Triangular Connector		6	3	U5055	48026
3.0, i		N52B30, N52B30A	07/05→02/07			6	3	U5055	48206
3.0, i		N52B30, N52B30A	07/05→02/07	Triangular Connector		6	3	U5058	48216
3.0, i		N53B30, N53B30A	02/07→03/10			6	3	U5039	48147
5 Series 530 E61									
3.0, i Touring		N52B30, N52B30A	07/05→02/07			6	3	U5055	48206
3.0, i Touring		N52B30, N52B30A	07/05→02/07	Triangular Connector		6	3	U5058	48216
3.0, i Touring		N53B30, N53B30A	02/07→03/11			6	3	U5039	48147
5 Series 535 E39									
3.5, i		M62B(358S1), M62B35	09/96→03/99			8	3	U5005	48009
3.5, i		M62B(358S2), M62B35TU	09/00→06/03			8	3	U5005	48009
5 Series 535 F07									
3.0, i GT		N55B30A	10/09→	Triangular Connector		6	3	U5055	48026
5 Series 535 F10									
3.0, i		N55B30A	03/10→	Triangular Connector		6	3	U5055	48026

LITRE / MODEL	BODY	ENGINE TYPE	DATE	ADDITIONAL INFORMATION	FITMENT INFORMATION	NO. OF COILS	NO. OF PINS	PART NO.	STOCK NO.
BMW (continued)									
5 Series 535 F11									
3.0, i Touring		N55B30A	09/10→	Triangular Connector		6	3	U5055	48026
5 Series 540 E34									
4.0, i	Sal	M60B40	01/93→09/95			8	3	U5012	48036
4.0, i Touring	Est	M60B40	05/94→03/96			8	3	U5012	48036
5 Series 540 E39									
4.4, i	Sal	M62448S2, M62B44, M62B44TU	06/96→06/03			8	3	U5005	48009
4.4, i Touring	Est	M62448S2, M62B44, M62B44TU	09/97→05/04			8	3	U5005	48009
5 Series 540 E60									
4.0, i		N62B40A	09/05→12/09	Triangular Connector		8	3	U5055	48026
5 Series 545 E60									
4.4, i		N62B44	09/03→11/05	Triangular Connector		8	3	U5055	48026
5 Series 545 E61									
4.4, i Touring		N62B44	06/04→11/05	Triangular Connector		8	3	U5055	48026
5 Series 550 E60									
4.8, i		N62B48B	09/05→03/10	Triangular Connector		8	3	U5055	48026
5 Series 550 E61									
4.8, i Touring		N62B48A, N62B48B	09/05→03/11	Triangular Connector		8	3	U5055	48026
5 Series 550 F07									
4.4, i GT		N63B44A	10/09→	Triangular Connector		8	3	U5055	48026
5 Series 550 F10									
4.4, i		N63B44A	03/10→			8	3	U5055	48206
5 Series 550 F11									
4.4, i Touring		N63B44A	07/11→	Triangular Connector		8	3	U5055	48026
5 Series M5 E34									
3.8		S38B38	03/92→09/95			6	3	U5012	48036
5 Series M5 E39									
4.9		S38B49, S62B50	05/99→06/03			8	3	U5005	48009
6 Series 628 E24									
2.8, CSi		M30B28	09/80→05/87		For Vehicles With Distributor	1	2	U1082	48345
6 Series 630 E63									
3.0, i		N52B30, N52B30A	09/04→10/07			6	3	U5055	48206
3.0, i		N52B30, N52B30A	09/04→10/07	Triangular Connector		6	3	U5058	48216
3.0, i		N53B30	09/07→08/11			6	3	U5039	48147
6 Series 630 E64									
3.0, i		N52B30, N52B30A	09/04→10/07			6	3	U5055	48206
3.0, i		N52B30, N52B30A	09/04→10/07	Triangular Connector		6	3	U5058	48216
3.0, i		N53B30	09/07→08/11			6	3	U5039	48147
6 Series 640 F12									
3.0, i		N55B30A	03/11→	Triangular Connector		6	3	U5055	48026
6 Series 645 E63									
4.4, Ci		N62B44, N62B44A	02/04→10/05	Triangular Connector		8	3	U5055	48026
6 Series 645 E64									
4.4, Ci		N62B44, N62B44A	04/04→10/05	Triangular Connector		8	3	U5055	48026
6 Series 650 E63									
4.8, i		N62B48B	09/05→08/11	Triangular Connector		8	3	U5055	48026
6 Series 650 E64									
4.8, i		N62B48B	09/05→08/11	Triangular Connector		8	3	U5055	48026
6 Series 650 F12									
4.4, i		N63B44A	03/11→03/13	Triangular Connector		8	3	U5055	48026
7 Series 728 E23									
2.8, i		M30B28	01/80→05/86		For Vehicles With Distributor	1	2	U1082	48345
7 Series 728 E38									
2.8, i		M52B28, M52B28TU	01/96→11/01			6	3	U5005	48009

LITRE / MODEL	BODY	ENGINE TYPE	DATE	ADDITIONAL INFORMATION	FITMENT INFORMATION	NO. OF COILS	NO. OF PINS	PART NO.	STOCK NO.
BMW (continued)									
7 Series 730 E32									
3.0, i		M60B30	09/92→08/94			8	3	U5012	48036
7 Series 730 E38									
3.0, i		M60B30	10/94→03/96			8	3	U5012	48036
7 Series 730 E65									
3.0, i		M54306S3, M54B30	03/03→04/05	Triangular Connector		6	3	U5055	48026
3.0, i		N52B30, N52B30A	03/05→04/06	Triangular Connector		6	3	U5058	48216
3.0, i		N52B30, N52B30A	04/06→04/09			6	3	U5055	48206
7 Series 730 E66									
3.0, Li		M54306S3, M54B30	03/03→04/05	Triangular Connector		6	3	U5055	48026
3.0, Li		N52B30, N52B30A	03/05→04/06	Triangular Connector		6	3	U5058	48216
3.0, Li		N52B30, N52B30A	04/06→04/09			6	3	U5055	48206
7 Series 735 E38									
3.5, i		M62B(358S1), M62B35	03/96→11/01			8	3	U5005	48009
7 Series 735 E65									
3.6, i		N62B36	11/01→04/05	Triangular Connector		8	3	U5055	48026
7 Series 735 E66									
3.6, Li		N62B36	04/02→04/05	Triangular Connector		8	3	U5055	48026
7 Series 740 E32									
4.0, i		M60B40	09/92→08/94			8	3	U5012	48036
4.0, iL		M60B40	09/92→08/94			8	3	U5012	48036
7 Series 740 E38									
4.0, i			10/94→03/96			8	3	U5012	48036
4.4, i		M62448S2, M62B44, M62B44TU	03/96→11/01			8	3	U5005	48009
4.4, iL		M62448S2, M62B44, M62B44TU	03/96→11/01			8	3	U5005	48009
7 Series 740 E65									
4.0, i		N62B40A	07/05→04/09	Triangular Connector		8	3	U5055	48026
7 Series 740 E66									
4.0, Li		N62B40A	07/05→04/09	Triangular Connector		8	3	U5055	48026
7 Series 740 F01									
3.0, i		N54B30A	11/08→			6	3	U5055	48206
7 Series 740 F02									
3.0, Li		N54B30A	11/08→			6	3	U5055	48206
7 Series 745 E65									
4.4, i		N62B44, N62B44A	11/01→04/05	Triangular Connector		8	3	U5055	48026
7 Series 745 E66									
4.4, Li		N62B44, N62B44A	04/02→04/05	Triangular Connector		8	3	U5055	48026
7 Series 750 E65									
4.8, i		N62B48B	07/05→04/09	Triangular Connector		8	3	U5055	48026
7 Series 750 E66									
4.8, Li		N62B48B	07/05→04/09	Triangular Connector		8	3	U5055	48026
7 Series 750 F01									
4.4, i		N63B44A	11/08→03/13			8	3	U5055	48206
7 Series 750 F02									
4.4, Li		N63B44A	11/08→03/13			8	3	U5055	48206
7 Series 760 E65									
6.0, i		N73B60	03/03→04/09	Triangular Connector		12	3	U5055	48026
7 Series 760 E66									
6.0, Li		N73B60	03/03→04/09	Triangular Connector		12	3	U5055	48026
7 Series 760 F02									
6.0, Li		N74B60A	09/09→			12	3	U5055	48206
8 Series 840 E31									
4.0, Ci		M60B40	07/93→02/96			8	3	U5012	48036
4.4, Ci		M62B44, M62B44TU	01/97→05/99			8	3	U5005	48009
X3 E83									
2.0, i		N46B20, N46B20A	09/05→11/06	Triangular Connector		4	3	U5055	48026

LITRE / MODEL	BODY	ENGINE TYPE	DATE	ADDITIONAL INFORMATION	FITMENT INFORMATION	NO. OF COILS	NO. OF PINS	PART NO.	STOCK NO.
BMW (continued)									
X3 E83									
2.5, i		M54256S5, M54B25	05/04→11/06	Triangular Connector		6	3	U5055	48026
2.5, si		N52B25A	09/06→04/09			6	3	U5055	48206
2.5, xDrive25i		N52B25A	09/08→03/11			6	3	U5055	48206
3.0, i		M54306S3, M54B30	05/04→11/06	Triangular Connector		6	3	U5055	48026
3.0, si		N52B30A	09/06→04/09			6	3	U5055	48206
3.0, xDrive30i		N52B30A	09/08→12/09			6	3	U5055	48206
X5 E53									
3.0, i		M54306S3, M54B30	10/00→10/02			6	3	U5005	48009
3.0, i		M54306S3, M54B30	11/02→09/06	Triangular Connector		6	3	U5055	48026
4.4, i		M62B44, M62B44TU	05/00→09/03			8	3	U5005	48009
4.4, i		N62B44, N62B44A	12/03→05/07	Triangular Connector		8	3	U5055	48026
4.6, i		M62B46, M67468S1	02/02→03/04			8	3	U5005	48009
4.8, i		N62B48A	05/04→09/06	Triangular Connector		8	3	U5055	48026
X5 E70									
3.0, si		N52B30, N52B30A	02/07→04/09			6	3	U5055	48206
3.0, xDrive30i		N52B30A	09/08→12/09			6	3	U5055	48206
4.4, M		S63B44A	09/09→			8	3	U5055	48206
4.4, xDrive50i		N63B44A	06/10→			8	3	U5055	48206
4.8, i		N62B48B	02/07→04/09	Triangular Connector		8	3	U5055	48026
4.8, xDrive48i		N62B48B	09/08→12/10	Triangular Connector		8	3	U5055	48026
X6 E71									
3.0, xDrive35i		N54B30A, N55B30A	05/08→			6	3	U5055	48206
4.4, M		S63B44A	09/09→			8	3	U5055	48206
4.4, xDrive50i		N63B44A	11/08→			8	3	U5055	48206
Z3 E36/7									
1.8		M43194E1, M43B19, M43B19TU	04/99→06/01			1	6	U2030	48133
1.9		M43194E1, M43B19, M43B19TU	06/01→01/03			1	6	U2030	48133
1.9		M44B19	01/97→03/99			1	6	U2030	48133
2.0		M52B(206S4), M52B20	04/99→09/00			6	3	U5005	48009
2.2		M54226S1, M54B22	10/00→01/03			6	3	U5005	48009
2.8		M52B28, M52B28TU	04/97→06/00			6	3	U5005	48009
3.0		M54306S3, M54B30	06/00→01/03			6	3	U5005	48009
3.2, M		S50B32	01/98→03/01			6	3	U5005	48009
3.2, M		S54B32, S54B32(326S4)	06/01→01/03	Triangular Connector		6	3	U5055	48026
Z3 E36/8									
3.2, M		S50B32	09/98→03/01			6	3	U5005	48009
3.2, M		S54326S4, S54B32	06/01→06/03	Triangular Connector		6	3	U5055	48026
Z4 E85									
2.0, i		N46B20, N46B20A	04/05→12/09	Triangular Connector		4	3	U5055	48026
2.2, i		M54226S1, M54B22	11/03→06/06	Triangular Connector		6	3	U5055	48026
2.5, i		M54256S5, M54B25	06/03→04/06	Triangular Connector		6	3	U5055	48026
2.5, i		N52B25A	02/06→12/09			6	3	U5055	48206
2.5, i		N52B25A	02/06→12/09	Triangular Connector		6	3	U5058	48216
2.5, si		N52B25A	02/06→12/09			6	3	U5055	48206
2.5, si		N52B25A	02/06→12/09	Triangular Connector		6	3	U5058	48216
3.0, i		M54306S3, M54B30	06/03→06/06	Triangular Connector		6	3	U5055	48026
3.0, si		N52B30, N52B30A	02/06→12/09			6	3	U5055	48206
3.0, si		N52B30, N52B30A	02/06→12/09	Triangular Connector		6	3	U5058	48216
3.2, M		S54326S4, S54B32	07/06→12/09	Triangular Connector		6	3	U5055	48026
Z4 E86									
3.0, si		N52B30, N52B30A	07/06→12/09			6	3	U5055	48206
3.0, si		N52B30, N52B30A	07/06→12/09	Triangular Connector		6	3	U5058	48216
3.2, M		S54326S4, S54B32	07/06→12/09	Triangular Connector		6	3	U5055	48026
Z4 E89									
2.5, sDrive23i		N52B25A	05/09→07/12			6	3	U5055	48206
2.5, sDrive23i		N52B25A	05/09→07/12	Triangular Connector		6	3	U5058	48216
3.0, sDrive30i		N52B30A	05/09→07/12			6	3	U5055	48206

LITRE / MODEL	BODY	ENGINE TYPE	DATE	ADDITIONAL INFORMATION	FITMENT INFORMATION	NO. OF COILS	NO. OF PINS	PART NO.	STOCK NO.
BMW (continued)									
Z4 E89									
3.0, sDrive35i		N54B30A	05/09→			6	3	U5055	48206
3.0, sDrive35is		N54B30A	09/10→			6	3	U5055	48206
Z8 E52									
5.0		S38B49, S62B50	06/00→06/03			8	3	U5005	48009

CADILLAC									
BLS (06→10)									
2.8, T 255	Est	Z28NET	01/08→08/10			6	4	U5049	48174
2.8, T 255	Sal	B284L	04/06→08/10			6	4	U5049	48174
CTS									
2.8	Sal	LP1	04/05→09/07			6	4	U5049	48174
2.8	Sal	LP1	09/08→12/10			6	4	U5049	48174
3.0	Est, Sal	LF1	06/11→12/14			6	4	U5130	49072
3.6	Sal	LLT	09/08→12/14			6	4	U5049	48174
3.6	Cpe, Est, Sal	LLT	02/11→12/14			6	4	U5130	49072
3.6	Sal	LY7	04/05→09/07			6	4	U5049	48174
Seville									
4.6		L37	10/00→03/02			4	2	U3015	48218
SRX									
3.0		LF1	01/09→			6	4	U5130	49072
3.6		LFX	10/12→			6	4	U5130	49072
3.6, LHD		LY7	07/05→03/08			6	4	U5049	48174

CHEVROLET									
Aveo T255 (08→12)									
1.2		B12D1	05/08→04/12	Oval Connector		1	3	U2031	48142
Camaro									
5.7, Z28		LS1	07/98→12/01			4	2	U3015	48218
Captiva (07→11)									
2.4		Z24SED	06/07→10/11	Oval Connector		1	3	U2031	48142
Cruze J300 (09→)									
1.6	Hbk, Sal	F16D3, F16D4	07/09→04/15			1	7	U6053	49076
1.8	Hbk, Sal	F18D4	07/09→	Oval Connector		1	3	U6035	48318
Kalos (05→08)									
1.2		B12S1	03/05→12/08	Oval Connector		1	3	U2031	48142
1.4		F14D3	03/05→12/08	Oval Connector		1	3	U2031	48142
Lacetti (05→11)									
1.4	Hbk	F14D3	03/05→12/11			1	4	U2062	48289
1.6	Est, Hbk	F16D3	03/05→12/11			1	4	U2062	48289
1.6	Sal	F16D3	01/05→09/07			1	4	U2062	48289
1.8	Est	F18D3	02/08→12/11	Oval Connector		1	3	U2031	48142
1.8	Est	F18D3	10/05→03/07	Oval Connector		1	3	U2031	48142
1.8	Hbk	F18D3	08/05→12/09	Oval Connector		1	3	U2031	48142
1.8	Hbk, Sal	F18D3	01/05→08/05	Oval Connector		1	3	U2031	48142
1.8	Hbk, Sal	T18SED	03/05→12/11	Oval Connector		1	3	U6035	48318
Matiz (05)									
0.8			06/05→12/05		For Vehicles Without Distributor	1	4	U2034	48153
1.0			01/05→07/05	Oval Connector		1	3	U2031	48142
Matiz (05→11)									
0.8		F8CV	12/05→03/11		For Vehicles Without Distributor	1	4	U2034	48153
1.0		B10S	06/05→03/11	Oval Connector		1	3	U2031	48142
Orlando (10→)									
1.8	Hbk, Sal	F18D4	02/11→04/15			1	7	U6053	49076

LITRE / MODEL	BODY	ENGINE TYPE	DATE	ADDITIONAL INFORMATION	FITMENT INFORMATION	NO. OF COILS	NO. OF PINS	PART NO.	STOCK NO.
CHEVROLET (continued)									
Tacuma (05→09)									
1.6		A16DMS	03/05→12/09	Oval Connector		1	3	U2031	48142
2.0		T20SED	03/05→12/08	Oval Connector		1	3	U2031	48142

CHRYSLER									
300									
3.5, C	Sal	3.5CSP	10/05→12/05			6	2	U5078	48259
3.5, C	Est	3.5CSP	04/06→09/07			6	3	U5105	48322
3.5, C	Sal	3.5CSP	01/06→06/08			6	3	U5105	48322
5.7, C	Sal	EZB, EZD, EZH	10/05→12/05			8	2	U4017	48264
5.7, C	Est	EZB, EZD, EZH	04/06→09/07			8	3	U5121	48265
5.7, C	Sal	EZB, EZD, EZH	01/06→09/07			8	3	U5121	48265
6.1, C SRT-8	Sal	ESF	03/06→03/11			8	3	U5121	48265
6.1, C SRT-8	Est	ESF	01/07→08/10			8	3	U5121	48265
Crossfire (03→08)									
3.2	Cnv	EGX	06/04→12/07			6	3	U3004	48024
3.2	Cpe	EGX	11/03→12/07			6	3	U3004	48024
3.2, SRT-6	Cnv, Cpe	EGZ	08/05→10/07			6	3	U3004	48024
Grand Voyager (01→08)									
3.3		EGA	02/01→09/07	Oval Connector		1	4	U2058	48261
Grand Voyager (08→)									
3.8		EGL	02/08→03/11	Oval Connector		1	4	U2057	48260
Neon (96→99)									
1.8		EBD	03/98→08/99		For Vehicles Without Distributor	1	3	U2041	48185
2.0		420H	06/96→08/99		For Vehicles Without Distributor	1	3	U2041	48185
Neon (99→04)									
2.0		420H, ECB	10/99→12/02		For Vehicles Without Distributor	1	3	U2044	48195
2.0, RT		ECH	10/01→12/02		For Vehicles Without Distributor	1	3	U2044	48195
PT Cruiser (00→08)									
2.0	Hbk	ECC	07/00→11/04		For Vehicles Without Distributor	1	3	U2044	48195
2.4	Cnv	EDZ	11/04→03/08		For Vehicles Without Distributor	1	3	U2044	48195
2.4	Hbk	EDZ	08/05→12/08		For Vehicles Without Distributor	1	3	U2044	48195
Sebring (07→10)									
2.0		ECN	07/07→12/10			4	3	U5104	48321
2.4		ED3, EDG	07/07→12/10			4	3	U5104	48321
Sebring (08→10)									
2.7		EER	04/08→12/10			6	3	U5105	48322
Voyager (97→01)									
2.0		C00	03/97→01/01		For Vehicles Without Distributor	1	3	U2044	48195
3.3		R00	03/97→12/98	Square Connector	For Vehicles Without Distributor	1	4	U2049	48220
3.3		R00	01/99→12/00	Oval Connector		1	4	U2058	48261
Voyager (01→08)									
2.4		EDZ	02/01→12/03		For Vehicles Without Distributor	1	3	U2044	48195
3.3		EGA	02/01→06/04	Oval Connector		1	4	U2057	48260
Ypsilon									
0.9, TwinAir		312A2.000	07/11→			2	3	U5156	48411

CITROEN									
2CV									
0.4, 4		A79/1(AYA2)	01/70→12/75			1	2	U3017	48233
0.6, 6		A06/635, A06/664	12/81→07/90			1	2	U3017	48233
AX (87→97)									
1.0, Carburettor		CDY(TU9M)	07/87→06/92		For Vehicles Without Distributor	1	4	U2017	48067
1.0, Injection		CDZ(TU9M)	06/92→04/97		For Vehicles Without Distributor	1	4	U2017	48067
1.1, Carburettor		H1A, H1B	05/91→05/92	Angular Connector	For Vehicles With Distributor	1	4	U1009	48066
1.1, Carburettor		H1A, H1B	07/87→04/91	Oval Connector	For Vehicles With Distributor	1	4	U1007	48062

LITRE / MODEL	BODY	ENGINE TYPE	DATE	ADDITIONAL INFORMATION	FITMENT INFORMATION	NO. OF COILS	NO. OF PINS	PART NO.	STOCK NO.
CITROEN (continued)									
AX (87→97)									
1.1, Injection		H1A, H1B	09/91→05/92	Angular Connector	For Vehicles With Distributor	1	4	U1009	48066
1.4, GT		K2A, K2B	01/88→04/91	Oval Connector	For Vehicles With Distributor	1	4	U1007	48062
1.4, GT		K2A, K2B	05/91→12/92	Angular Connector	For Vehicles With Distributor	1	4	U1009	48066
1.4, GTi		KFZ(TU3FJ2)	01/92→07/94		For Vehicles Without Distributor	1	4	U2017	48067
1.4, Injection		KDX(TU3M/Z)	01/93→07/95		For Vehicles Without Distributor	1	4	U2017	48067
1.4, Injection		KDY(TU3M)	08/92→07/95	Angular Connector	For Vehicles With Distributor	1	4	U1009	48066
1.4, TRS		K1F	06/88→12/89	Oval Connector	For Vehicles With Distributor	1	4	U1007	48062
1.4, TZS/TZX		KDZ(TU3M/Z), KDY(TU3M)	06/88→04/91	Oval Connector	For Vehicles With Distributor	1	4	U1007	48062
1.4, TZS/TZX		KDY(TU3M)	05/91→07/92	Angular Connector	For Vehicles With Distributor	1	4	U1009	48066
Berlingo (96→02)									
1.4	Van	KFW(TU3JP)	10/98→12/02	White Connector		1	4	U6005	48016
1.4	Van	KFX(TU3JP)	11/00→12/02	Grey Connector		1	4	U6004	48014
1.6, Multispace	MPV	NFU(TU5JP4)	11/00→12/02	Grey Connector		1	4	U6004	48014
1.8, Multispace	MPV	LFX(XU7JB)	04/99→07/01		For Vehicles Without Distributor	1	4	U2009	48030
Berlingo (02→12)									
1.4	Van	KFW(TU3JP)	10/02→12/08	White Connector		1	4	U6005	48016
1.4, First	MPV	KFW(TU3JP)	03/09→03/10	White Connector		1	4	U6005	48016
1.4, First	Van		10/02→12/10	White Connector		1	4	U6005	48016
1.4, Multispace	MPV	KFW(TU3JP)	10/02→12/08	White Connector		1	4	U6005	48016
1.4, Multispace	MPV	KFX(TU3JP)	10/02→12/08	Black Connector		1	4	U6008	48023
1.6, Multispace	MPV	NFU(TU5JP4)	10/02→12/08	Grey Connector		1	4	U6004	48014
Berlingo (08→)									
1.6	Van	NFR(TU5JP4B)	06/08→04/12	Grey Connector		1	4	U6004	48014
1.6, Dual Fuel	Van	NFR(TU5JP4B)	09/08→04/11	Grey Connector		1	4	U6004	48014
1.6, Multispace	MPV	NFR(TU5JP4B)	06/08→04/11	Grey Connector		1	4	U6004	48014
1.6, Multispace	MPV	NFU(TU5JP4)	06/08→08/10	Grey Connector		1	4	U6004	48014
1.6, Multispace VTi 95	MPV	5FK(EP6CB)	08/10→			4	3	U5055	48206
1.6, VTi 95	Van	EP6C	09/11→			4	3	U5055	48206
BX (83→95)									
1.4	Hbk	150C	08/83→12/91	Oval Connector	For Vehicles With Distributor	1	4	U1007	48062
1.4	Hbk	150C	08/83→12/91		For Vehicles With Distributor	1	2	U1076	48339
1.4, 14/TE	Hbk	150A	08/83→06/88	Oval Connector	For Vehicles With Distributor	1	4	U1007	48062
1.4, 14/TE	Hbk	150A	08/83→06/88		For Vehicles With Distributor	1	2	U1076	48339
1.4, Injection	Hbk	KDY(TU3M), KDZ(TU3M/Z)	12/89→12/92	Oval Connector	For Vehicles With Distributor	1	4	U1007	48062
1.6	Est	171C	08/85→01/92	Oval Connector	For Vehicles With Distributor	1	4	U1007	48062
1.6	Est	171C	08/85→01/92	Oval Connector, With Bracket	For Vehicles With Distributor	1	4	U1029	48132
1.6	Est	171C	08/85→01/92		For Vehicles With Distributor	1	2	U1076	48339
1.6	Hbk	XU52C	03/88→07/92	Oval Connector, With Bracket	For Vehicles With Distributor	1	4	U1029	48132
1.6	Hbk	XU52C	08/83→02/88		For Vehicles With Distributor	1	2	U1076	48339
1.6, Injection	Est	BDY(XU5M)	09/92→12/94		For Vehicles Without Distributor	1	4	U2009	48030
1.6, RE/RE Leader	Hbk	B1E(XU51C)	10/87→12/89	Oval Connector	For Vehicles With Distributor	1	4	U1007	48062
1.6, RE/RE Leader	Hbk	B1E(XU51C)	10/87→12/89	Oval Connector, With Bracket	For Vehicles With Distributor	1	4	U1029	48132
1.6, RE/RE Leader	Hbk	B1E(XU51C)	10/87→12/89		For Vehicles With Distributor	1	2	U1076	48339
1.9	Est	DDZ(XU9M)	10/90→05/91		Incl. Control Unit, For Vehicles With Distributor	1	5	U1032	48143
1.9	Hbk	D6C(XU9J4)	10/87→12/88	Oval Connector	For Vehicles With Distributor	1	4	U1007	48062
1.9	Hbk	D6C(XU9J4)	10/87→12/88	Oval Connector, With Bracket	For Vehicles With Distributor	1	4	U1029	48132
1.9, Carburettor	Est	D2A(XU92C), DDZ(XU9M)	06/88→12/92	Oval Connector	For Vehicles With Distributor	1	4	U1007	48062
1.9, Carburettor	Est	D2A(XU92C), DDZ(XU9M)	06/88→12/92	Oval Connector, With Bracket	For Vehicles With Distributor	1	4	U1029	48132
1.9, Carburettor	Est	D2A(XU92C), DDZ(XU9M)	07/86→04/89		For Vehicles With Distributor	1	2	U1076	48339
1.9, Carburettor	Hbk	D2A(XU92C)	07/86→05/89	Oval Connector	For Vehicles With Distributor	1	4	U1007	48062
1.9, Carburettor	Hbk	D2A(XU92C)	07/86→05/89	Oval Connector, With Bracket	For Vehicles With Distributor	1	4	U1029	48132
1.9, Carburettor	Hbk	D2A(XU92C)	07/86→05/89		For Vehicles With Distributor	1	2	U1076	48339
1.9, GTi	Hbk	D6A(XU9J2)	04/90→12/92		For Vehicles Without Distributor	1	4	U2009	48030
1.9, GTi	Hbk	D6A(XU9J2)	05/87→04/90	Oval Connector	For Vehicles With Distributor	1	4	U1007	48062

LITRE / MODEL	BODY	ENGINE TYPE	DATE	ADDITIONAL INFORMATION	FITMENT INFORMATION	NO. OF COILS	NO. OF PINS	PART NO.	STOCK NO.
CITROEN (continued)									
BX (83→95)									
1.9, GTi	Hbk	D6A(XU9J2)	05/87→04/90	Oval Connector, With Bracket	For Vehicles With Distributor	1	4	U1029	48132
1.9, GTi	Hbk	D6A(XU9J2)	08/86→05/87		For Vehicles With Distributor	1	2	U1076	48339
1.9, GTi (catalyst)	Hbk	D6A(XU9J2)	01/92→02/93		For Vehicles Without Distributor	1	4	U2009	48030
1.9, Injection	Est	D6A(XU9J2)	04/88→04/90	Oval Connector	For Vehicles With Distributor	1	4	U1007	48062
1.9, Injection	Est	D6A(XU9J2)	04/88→04/90	Oval Connector, With Bracket	For Vehicles With Distributor	1	4	U1029	48132
1.9, Injection	Est, Hbk	D6A(XU9J2)	04/90→12/92		For Vehicles Without Distributor	1	4	U2009	48030
1.9, Injection	Hbk	D6A(XU9J2)	03/90→04/90	Oval Connector	For Vehicles With Distributor	1	4	U1007	48062
1.9, Injection	Hbk	D6A(XU9J2)	03/90→04/90	Oval Connector, With Bracket	For Vehicles With Distributor	1	4	U1029	48132
C1 (05→)									
1.0		1KR-FE	07/05→09/12			3	4	U5029	48107
C2 (03→10)									
1.1		TU1A	01/05→12/10			1	4	U6015	48074
1.1		TU1JP	09/03→04/05	White Connector		1	4	U6005	48016
1.4		KFU(ET3J4)	06/06→12/09			1	6	U6021	48124
1.4		TU3A	09/03→12/10			1	4	U6015	48074
1.4		TU3JP	09/03→04/05	White Connector		1	4	U6005	48016
1.6, VTR/GT		NFU(TU5JP4)	09/03→12/09	Grey Connector		1	4	U6004	48014
1.6, VTS		NFS(TU5JP4S)	01/05→12/10	Grey Connector		1	4	U6004	48014
C3 (02→10)									
1.1		HFX(TU1JP)	08/02→12/10	White Connector		1	4	U6005	48016
1.4		KFU(ET3J4)	02/04→03/10			1	6	U6021	48124
1.4		KFV(TU3JP)	04/02→08/10	White Connector		1	4	U6005	48016
1.6		NFU(TU5JP4)	04/02→08/10	Grey Connector		1	4	U6004	48014
C3 (10→)									
1.1			01/10→08/13			1	4	U6015	48074
1.4		KFT(TU3A)	01/10→08/13			1	4	U6015	48074
1.4, VTi 95			01/10→			4	3	U5055	48206
1.6, VTi 120		5FS(EP6C)	01/10→			4	3	U5055	48206
C3 Picasso (09→)									
1.4, VTi 95		8FS(EP3)	05/09→			4	3	U5055	48206
1.6, VTi 120		5FS(EP6C), 5FW(EP6)	05/09→			4	3	U5055	48206
C3 Pluriel (03→10)									
1.4		KFV(TU3JP)	05/03→12/10	White Connector		1	4	U6005	48016
1.6		NFU(TU5JP4)	05/03→12/10	Grey Connector		1	4	U6004	48014
C3 XTR (02→10)									
1.4		KFU(ET3J4)	05/04→04/07			1	6	U6021	48124
C4 (04→11)									
1.4	Cpe	KFU(ET3J4)	11/04→08/10			1	6	U6021	48124
1.4	Hbk	KFU(ET3J4)	11/04→12/10			1	6	U6021	48124
1.6	Cpe, Hbk	NFU(TU5JP4)	11/04→03/09	Grey Connector		1	4	U6004	48014
1.6, Bioflex	Cpe, Hbk	NFU(TU5JP4)	04/08→03/09	Grey Connector		1	4	U6004	48014
1.6, VTi 120	Cpe, Hbk	5FW(EP6)	10/08→03/11			4	3	U5055	48206
1.6, VTS 150	Cpe	5FX(EP6DT)	09/08→08/10			4	3	U5055	48206
2.0	Hbk	RFJ(EW10A)	11/04→12/07			1	6	U6013	48071
2.0, VTR	Cpe	RFN(EW10J4)	11/04→12/07			1	4	U6009	48032
2.0, VTS	Cpe	RFK(EW10J4S)	11/04→12/08			1	6	U6014	48072
C4 (11→)									
1.4, VTi 95		8FP(EP3)	03/11→			4	3	U5055	48206
1.6, THP 155		5FV(EP6CDT)	01/11→			4	3	U5055	48206
1.6, VTi 120		5FS(EP6C)	01/11→			4	3	U5055	48206
C4 Grand Picasso (07→)									
1.6, HTP 140		5FT(EP6DT)	09/08→06/09			4	3	U5055	48206
1.6, HTP 140 Automatic		5FT(EP6DT)	03/09→08/10			4	3	U5055	48206
1.6, HTP 150 Manual		5FX(EP6DT)	03/09→03/11			4	3	U5055	48206
1.6, HTP 155		5FV(EP6CDT)	09/10→12/12			4	3	U5055	48206
1.6, VTi 120		5FW(EP6)	09/08→			4	3	U5055	48206

LITRE / MODEL	BODY	ENGINE TYPE	DATE	ADDITIONAL INFORMATION	FITMENT INFORMATION	NO. OF COILS	NO. OF PINS	PART NO.	STOCK NO.
CITROEN (continued)									
C4 Grand Picasso (07→)									
1.8		6FY-EW7A	01/07→03/09			1	6	U6013	48071
2.0		RFJ(EW10A)	01/07→06/09			1	6	U6013	48071
C4 Picasso (06→)									
1.6, HTP 140		5FT(EP6DT)	09/08→06/09			4	3	U5055	48206
1.6, HTP 140 Automatic		5FT(EP6DT)	03/09→08/10			4	3	U5055	48206
1.6, HTP 150		5FX(EP6DT)	01/10→03/11			4	3	U5055	48206
1.6, HTP 150 Manual		5FX(EP6DT)	03/09→08/10			4	3	U5055	48206
1.6, HTP 155		5FV(EP6CDT)	09/10→			4	3	U5055	48206
1.6, VTi 120		5FW(EP6)	09/08→			4	3	U5055	48206
1.8		6FY-EW7A	02/07→03/09			1	6	U6013	48071
2.0		RFJ(EW10A)	02/07→03/09			1	6	U6013	48071
C5 (01→08)									
1.8	Est	6FY-EW7A	10/05→07/07			1	6	U6013	48071
1.8	Est	6FZ(EW7J4)	06/01→08/04			1	4	U6009	48032
1.8	Est, Hbk	6FZ(EW7J4)	09/04→10/05			1	4	U6009	48032
1.8	Hbk	6FY-EW7A	10/05→08/08			1	6	U6013	48071
1.8	Hbk	6FZ(EW7J4)	04/01→08/04			1	4	U6009	48032
2.0	Est	RFJ(EW10A), RLZ(EW10D)	09/04→08/08			1	6	U6013	48071
2.0	Est	RLZ(EW10D)HPi	06/01→08/04			1	6	U6034	48282
2.0	Hbk	RFJ(EW10A)	09/04→08/08			1	6	U6013	48071
2.0	Hbk	RLZ(EW10D)HPi	04/01→08/04			1	6	U6034	48282
2.0, HPi	Est	RLZ(EW10D)HPi	06/01→06/03			1	6	U6034	48282
2.0, HPi	Hbk	RLZ(EW10D)HPi	04/01→06/03			1	6	U6034	48282
3.0	Est	XFV(ES9A), XFX(ES9J4S)	06/01→07/07			6	2	U5008	48031
3.0	Hbk	XFV(ES9A), XFX(ES9J4S)	04/01→12/07			6	2	U5008	48031
C5 (08→)									
1.6, THP 155	Est	5FV(EP6DT)	09/09→08/10			4	3	U5055	48206
1.6, THP 155	Sal	5FV(EP6DT)	09/09→03/13			4	3	U5055	48206
1.8	Est	6FY-EW7A	05/08→06/10			1	6	U6013	48071
1.8	Sal	6FY-EW7A	03/08→06/10			1	6	U6013	48071
2.0	Est	RFJ(EW10A)	05/08→06/10			1	6	U6013	48071
2.0	Sal	RFJ(EW10A)	03/08→06/10			1	6	U6013	48071
C6 (06→12)									
3.0		XFV(ES9A), XFX(ES9J4S)	03/06→06/10			6	2	U5008	48031
C8 (03→11)									
2.0		RFJ(EW10A)	10/05→05/09			1	6	U6013	48071
2.0		RFN(EW10J4)	01/03→10/05			1	4	U6009	48032
2.2		3FZ(EW12J4)	01/03→03/06			1	6	U6014	48072
C15 (85→06)									
1.1		109K, E1A	01/85→12/94	Oval Connector, With Bracket	For Vehicles With Distributor	1	4	U1029	48132
1.1		109K, E1A	01/85→12/94		For Vehicles With Distributor	1	2	U1076	48339
C25 (87→92)									
1.8		169(XM7T)	07/87→10/92		For Vehicles With Distributor	1	2	U1076	48339
2.0		170A(XN1T), 170B(XN1T)	04/87→10/92		For Vehicles With Distributor	1	2	U1076	48339
C25 (92→94)									
2.0, Relay		170A(XN1T), 170B(XN1T)	10/92→03/94		For Vehicles With Distributor	1	2	U1076	48339
CX (74→91)									
2.0, 20	Est, Sal	829A5	06/79→08/85		For Vehicles With Distributor	1	2	U1076	48339
2.0, 20	Est, Sal	829A5	06/79→08/85		For Vehicles With Distributor	1	2	U1079	48342
2.0, 20	Est	829A5	08/85→08/86		For Vehicles With Distributor	1	2	U1076	48339
2.0, 20	Est	829A5	08/85→08/86		For Vehicles With Distributor	1	2	U1079	48342
2.0, 20	Sal	829A5	08/85→07/87		For Vehicles With Distributor	1	2	U1076	48339
2.0, 20	Sal	829A5	08/85→07/87		For Vehicles With Distributor	1	2	U1079	48342
2.2, 22	Sal	J6TA500	09/85→07/89		For Vehicles With Distributor	1	2	U1076	48339
2.2, 22	Sal	J6TA500	09/85→07/89		For Vehicles With Distributor	1	2	U1079	48342
2.2, 22	Est	J6TA500	09/87→07/91		For Vehicles With Distributor	1	2	U1076	48339
2.2, 22	Est	J6TA500	09/87→07/91		For Vehicles With Distributor	1	2	U1079	48342

LITRE / MODEL	BODY	ENGINE TYPE	DATE	ADDITIONAL INFORMATION	FITMENT INFORMATION	NO. OF COILS	NO. OF PINS	PART NO.	STOCK NO.
CITROEN (continued)									
CX (74→91)									
2.3, 2400 Carburettor	Est	M23-639	05/80→05/82		For Vehicles With Distributor	1	2	U1065	48302
2.5, 25	Est	M25-659	08/85→07/91		For Vehicles With Distributor	1	2	U1076	48339
2.5, 25	Est, Sal	M25-659	10/83→08/85		For Vehicles With Distributor	1	2	U1076	48339
2.5, 25	Sal	M25-659	08/85→07/87		For Vehicles With Distributor	1	2	U1076	48339
2.5, 25 GTi Turbo	Sal	M25-662	09/84→12/89		For Vehicles With Distributor	1	2	U1076	48339
Dispatch (07→)									
2.0		RFH(EW10A)	03/09→03/11			1	6	U6013	48071
2.0, Dual Fuel		RFH(EW10A)	03/09→03/11			1	6	U6013	48071
DS3 A55 (09→)									
1.4, VTi 95		8FP(EP3)	04/10→			4	3	U5055	48206
1.6, HTP 150		5FR(EP6DT)	04/10→04/12			4	3	U5055	48206
1.6, HTP 155		5FR(EP6DT)	09/11→			4	3	U5055	48206
1.6, Racing			02/11→			4	3	U5055	48206
1.6, VTi 120		5FS(EP6C)	04/10→			4	3	U5055	48206
DS4 (11→)									
1.6, THP 155		5FV(EP6CDT)	04/11→03/12			4	3	U5055	48206
1.6, THP 200		5FU(EP6DTX)	04/11→			4	3	U5055	48206
1.6, VTi 120		5FS(EP6C)	04/11→			4	3	U5055	48206
DS5 (11→)									
1.6, THP 200		5FU(EP6DTX)	12/11→			4	3	U5055	48206
Dyane 4 (67→82)									
0.4		A79/1(AYA2)	01/70→07/75			1	2	U3017	48233
Dyane 6 (67→82)									
0.6		M28/1(AK2)	01/80→12/80			1	2	U3017	48233
GSA (79→84)									
1.3	Est, Hbk	G13/625, G13/646	01/80→07/85		For Vehicles With Distributor	1	2	U1076	48339
LNA LNA II									
1.1		109/5E	07/82→04/85		For Vehicles With Distributor	1	2	U1076	48339
Nemo (08→)									
1.4	Van	KVF(TU3A), TU3AE5	05/08→			1	4	U6015	48074
1.4, Dual Fuel	Van	KVF(TU3A), TU3AE5	09/08→03/11			1	4	U6015	48074
1.4, Multispace	MPV	KFV(TU3A), TU3AE5	04/09→03/11			1	4	U6015	48074
Relay 244 (02→07)									
2.0		XU10J2	04/02→12/05		For Vehicles Without Distributor	1	4	U2009	48030
Saxo (96→99)									
1.0		CDZ(TU9M)	05/98→10/99		For Vehicles Without Distributor	1	4	U2009	48030
1.1		HDZ(TU1M)	05/96→10/99		For Vehicles Without Distributor	1	4	U2009	48030
1.1		HFX(TU1JP)	05/96→10/99	White Connector		1	4	U6005	48016
1.4		KFW(TU3JP)	02/98→10/99	Black Connector		1	4	U6008	48023
1.4		KFX(TU3JP)	05/96→01/98		For Vehicles Without Distributor	1	4	U2009	48030
1.6		NFZ(TU5JP)	06/98→10/99	Black Connector		1	4	U6008	48023
1.6		NFZ(TU5JP)	09/96→05/98		For Vehicles Without Distributor	1	4	U2009	48030
1.6, VTS		NFX(TU5JP4)	01/97→10/99	Black Connector		1	4	U6011	48045
1.6, VTS		NFX(TU5JP4)	01/97→10/99	Grey Connector		1	4	U6017	48076
Saxo (99→04)									
1.0		CDZ(TU9M)	10/99→12/00		For Vehicles Without Distributor	1	4	U2009	48030
1.1		HDZ(TU1M)	10/99→09/03		For Vehicles Without Distributor	1	4	U2009	48030
1.1		HFX(TU1JP)	10/99→09/03	White Connector		1	4	U6005	48016
1.4		KFW(TU3JP)	06/00→06/03	White Connector		1	4	U6005	48016
1.4		KFW(TU3JP)	10/99→05/00	Black Connector		1	4	U6008	48023
1.6, VTR		NFT	02/01→02/04	White Connector		1	4	U6005	48016
1.6, VTR		NFZ(TU5JP)	10/99→09/00	Black Connector		1	4	U6008	48023
1.6, VTS		NFX(TU5JP4)	10/99→09/03	Black Connector		1	4	U6011	48045
1.6, VTS		NFX(TU5JP4)	10/99→09/03	Grey Connector		1	4	U6017	48076
Synergie (95→02)									
2.0		RFN(EW10J4)	05/00→07/02			1	4	U6012	48051

LITRE / MODEL	BODY	ENGINE TYPE	DATE	ADDITIONAL INFORMATION	FITMENT INFORMATION	NO. OF COILS	NO. OF PINS	PART NO.	STOCK NO.
CITROEN (continued)									
Synergie (95→02)									
2.0		RFU(XU10J2/C)	10/95→05/00		For Vehicles Without Distributor	1	4	U2009	48030
Visa (78→88)									
1.0	Hbk		09/85→10/87		For Vehicles With Distributor	1	2	U1076	48339
1.1	Cnv	109/5F	10/83→10/85		For Vehicles With Distributor	1	2	U1076	48339
1.1	Hbk	109/5F	07/82→10/87		For Vehicles With Distributor	1	2	U1076	48339
1.4	Hbk	150D(XY7)	09/84→07/86		For Vehicles With Distributor	1	2	U1076	48339
1.4, GT	Hbk	150B(XY8)	07/82→12/85		For Vehicles With Distributor	1	2	U1076	48339
1.6, GTi	Hbk	180A(XU5J)	07/85→06/86		For Vehicles With Distributor	1	2	U1076	48339
Xantia (93→01)									
1.6	Hbk	BFZ(XU5JP)	07/93→12/97		For Vehicles Without Distributor	1	4	U2009	48030
1.8	Est	LFZ(XU7JP)	09/95→01/98		For Vehicles Without Distributor	1	4	U2009	48030
1.8	Est, Hbk	LFZ(XU7JP)	09/95→09/97			1	4	U6040	48405
1.8	Hbk	LFY(XU7JP4)	09/97→01/98			1	4	U6012	48051
1.8	Est, Hbk	LFY(XU7JP4)	01/98→12/01			1	4	U6012	48051
1.8	Hbk	LFZ(XU7JP)	07/93→09/95		For Vehicles Without Distributor	1	4	U2009	48030
1.8, Dual Fuel	Hbk	LFY(XU7JP4)	10/99→10/00			1	4	U6012	48051
2.0	Est, Hbk	RFV(XU10J4R)	06/95→09/97			1	4	U6040	48405
2.0	Est, Hbk	RFV(XU10J4R)	09/97→12/00			1	4	U6012	48051
2.0	Hbk	RFX(XU10J2C)	05/93→07/98		For Vehicles Without Distributor	1	4	U2009	48030
2.0, Turbo	Est, Hbk	RGX(XU10J2TE)	02/96→12/00		For Vehicles Without Distributor	1	4	U2009	48030
2.0, VSX	Hbk	RFY(XU10J4/Z)	05/93→12/95			4	3	U5044	48163
3.0	Hbk	XFZ(ES9J4)	06/97→12/00			1	4	U6016	48075
XM (89→00)									
2.0	Est, Hbk	RFV(XU10J4R)	06/95→09/97			1	4	U6040	48405
2.0	Est, Hbk	RFV(XU10J4R)	09/97→10/00			1	4	U6012	48051
2.0, Carburettor	Hbk		10/89→12/92	Angular Connector	For Vehicles With Distributor	1	4	U1009	48066
2.0, Carburettor	Hbk		10/89→12/92		For Vehicles Without Distributor	1	4	U2009	48030
2.0, Injection	Hbk	R6A	10/89→06/94	Angular Connector	For Vehicles With Distributor	1	4	U1009	48066
2.0, Injection	Hbk	R6A	10/89→06/94		For Vehicles Without Distributor	1	4	U2009	48030
2.0, Turbo	Est	RGX(XU10J2TE), RGY(XU10J2TE/Z)	07/94→10/00	Angular Connector	For Vehicles With Distributor	1	4	U1009	48066
2.0, Turbo	Est	RGX(XU10J2TE), RGY(XU10J2TE/Z)	07/94→10/00		For Vehicles Without Distributor	1	4	U2009	48030
2.0, Turbo	Est	RGY(XU10J2TE/Z)	01/93→04/94		For Vehicles Without Distributor	1	4	U2009	48030
2.0, Turbo	Hbk	RGX(XU10J2TE)	07/94→10/00	Angular Connector	For Vehicles With Distributor	1	4	U1009	48066
2.0, Turbo	Hbk	RGX(XU10J2TE)	07/94→10/00		For Vehicles Without Distributor	1	4	U2009	48030
2.0, Turbo	Hbk	RGY(XU10J2TE/Z)	01/93→06/94		For Vehicles Without Distributor	1	4	U2009	48030
3.0	Est, Hbk	XFZ(ES9J4)	05/97→10/00			1	4	U6016	48075
Xsara (97→00)									
1.4	Hbk	KFW(TU3JP), KFX(TU3JP)	11/97→08/00	Black Connector		1	4	U6008	48023
1.4	Hbk	KFX(TU3JP)	11/97→05/98		For Vehicles Without Distributor	1	4	U2009	48030
1.4	Cpe	KFW(TU3JP), KFX(TU3JP)	10/98→08/00	Black Connector		1	4	U6008	48023
1.4	Est	KFW(TU3JP), KFX(TU3JP)	04/98→08/00	Black Connector		1	4	U6008	48023
1.6	Hbk	NFZ(TU5JP)	11/97→05/98		For Vehicles Without Distributor	1	4	U2009	48030
1.6	Cpe	NFZ(TU5JP)	03/98→05/98		For Vehicles Without Distributor	1	4	U2009	48030
1.6	Cpe, Est, Hbk	NFZ(TU5JP)	06/98→09/00	Black Connector		1	4	U6008	48023
1.8	Cpe, Hbk	LFY(XU7JP4)	04/97→11/97			1	4	U6040	48405
1.8	Hbk	LFY(XU7JP4)	11/97→09/00			1	4	U6012	48051
1.8	Cpe	LFY(XU7JP4)	05/98→09/00			1	4	U6012	48051
1.8	Hbk	LFZ(XU7JP)	11/97→09/00		For Vehicles Without Distributor	1	4	U2009	48030
1.8	Est	LFZ(XU7JP)	10/97→05/98			1	4	U6040	48405
1.8	Est	LFZ(XU7JP)	04/98→09/00		For Vehicles Without Distributor	1	4	U2009	48030
2.0	Cpe	RFS(XU10J4RS)	03/98→10/00			4	2	U5021	48073
Xsara (00→04)									
1.4	Est	KFW(TU3JP)	10/00→12/01	White Connector		1	4	U6005	48016
1.4	Hbk	KFW(TU3JP)	10/00→12/04	White Connector		1	4	U6005	48016

LITRE / MODEL	BODY	ENGINE TYPE	DATE	ADDITIONAL INFORMATION	FITMENT INFORMATION	NO. OF COILS	NO. OF PINS	PART NO.	STOCK NO.
CITROEN (continued)									
Xsara (00→04)									
1.6	Cpe, Est, Hbk	NFU(TU5JP4)	10/00→12/04	Grey Connector		1	4	U6004	48014
2.0	Cpe	RFS(XU10J4RS)	10/00→12/04			4	2	U5021	48073
2.0	Hbk	RFN(EW10J4)	10/00→04/02			1	4	U6009	48032
Xsara Picasso (00→10)									
1.6		NFU(TU5JP4)	10/05→12/10	Grey Connector		1	4	U6004	48014
1.6		NFV(TU5JP)	06/00→12/05	White Connector		1	4	U6005	48016
1.6		NFV(TU5JP)	06/00→12/05	Black Connector		1	4	U6008	48023
1.8		6FZ(EW7J4)	06/00→03/06			1	4	U6009	48032
2.0		RFN(EW10J4)	03/03→08/07			1	4	U6009	48032
ZX (91→97)									
1.4	Est	KDX(TU3M/Z), KDY(TU3M), KFX(TU3JP)	05/94→10/97	Angular Connector	For Vehicles With Distributor	1	4	U1009	48066
1.4	Est	KDX(TU3M/Z), KDY(TU3M), KFX(TU3JP)	05/94→10/97		For Vehicles Without Distributor	1	4	U2017	48067
1.4, Carburettor	Hbk	KDZ(TU3M/Z)	06/91→12/92	Angular Connector	For Vehicles With Distributor	1	4	U1009	48066
1.4, Carburettor	Hbk	KDZ(TU3M/Z)	06/91→12/92		For Vehicles Without Distributor	1	4	U2017	48067
1.4, Injection	Hbk	KDX(TU3M/Z), KDZ(TU3M/Z), KFX(TU3JP)	04/92→06/97	Angular Connector	For Vehicles With Distributor	1	4	U1009	48066
1.4, Injection	Hbk	KDX(TU3M/Z), KDZ(TU3M/Z), KFX(TU3JP)	04/92→06/97		For Vehicles Without Distributor	1	4	U2017	48067
1.6	Hbk	BDY(XU5M), BFZ(XU5JP)	06/91→07/93		For Vehicles Without Distributor	1	4	U2009	48030
1.8	Est, Hbk	LFY(XU7JP4)	07/94→10/97		For Vehicles Without Distributor	1	4	U2009	48030
1.8	Est, Hbk	LFY(XU7JP4)	01/96→06/97			1	4	U6040	48405
1.9, Volcane	Hbk	D6E(XU9JA)	06/91→07/94		For Vehicles Without Distributor	1	4	U2009	48030
2.0	Hbk	RFT(XU10J4/Z), RFY(XU10J4/Z)	10/92→10/94			4	3	U5044	48163
2.0, Volcane	Hbk		07/94→07/96		For Vehicles Without Distributor	1	4	U2009	48030

DACIA									
Logan (13→)									
1.1		D4F732	04/13→04/16			1	4	U6052	49075
Sandero									
0.9, Tce 90			12/12→			3	3	U5155	48410
Sandero (12→)									
1.1		D4F732	12/12→04/16			1	4	U6052	49075

DAEWOO									
Espero (95→97)									
1.5		A15MF	04/95→09/97			1	4	U1031	48141
1.8		C18LE	04/95→09/97			1	4	U1031	48141
2.0		C20LE	04/95→09/97			1	4	U1031	48141
2.0		C20LE	04/95→09/97		For Vehicles With Distributor	1	4	U1054	48217
Kalos (02→05)									
1.2		B12S1	08/03→01/05	Oval Connector		1	3	U2031	48142
1.4		F14D3	08/03→01/05	Oval Connector		1	3	U2031	48142
1.4		F14S3	10/02→01/05	Oval Connector		1	3	U2031	48142
Korando (99→02)									
2.3		M161.970	03/99→03/02			2	1	U4026	48018
Lacetti (04→05)									
1.4		F14D3	03/04→01/05			1	4	U2062	48289
1.6		F16D3	03/04→01/05			1	4	U2062	48289
1.8		T18SED	09/04→01/05	Oval Connector		1	3	U6035	48318
Lanos (97→02)									
1.4	Hbk	A14SMS	09/97→12/02	Oval Connector, To Ch. No.: 580699		1	4	U2018	48070
1.4	Hbk	A14SMS	09/97→12/02	Oval Connector		1	3	U2031	48142

LITRE / MODEL	BODY	ENGINE TYPE	DATE	ADDITIONAL INFORMATION	FITMENT INFORMATION	NO. OF COILS	NO. OF PINS	PART NO.	STOCK NO.
DAEWOO (continued)									
Lanos (97→02)									
1.4, Dual Fuel	Hbk	A14SMS	03/00→12/02	Oval Connector, To Ch. No.: 580699		1	4	U2018	48070
1.4, Dual Fuel	Hbk	A14SMS	03/00→12/02	Oval Connector		1	3	U2031	48142
1.6	Hbk, Sal	A16DMS	09/97→12/02	Oval Connector, To Ch. No.: 580699		1	4	U2018	48070
1.6, Dual Fuel	Sal	A16DMS	03/00→12/02	Oval Connector, To Ch. No.: 580699		1	4	U2018	48070
Leganza (97→02)									
2.0	Est, Sal	X20SED	09/97→12/02	Oval Connector		1	4	U2018	48070
2.0, Dual Fuel	Sal	X20SED	03/00→12/02	Oval Connector		1	4	U2018	48070
Matiz (98→05)									
0.8		F8CV	09/98→01/05	To Ch. No.: 577030	For Vehicles With Distributor	1	2	U1028	48129
0.8		F8CV	09/98→01/05		For Vehicles Without Distributor	1	4	U2034	48153
1.0		B10S	01/03→01/05	Oval Connector		1	3	U2031	48142
Musso (99→02)									
2.3		M111.970	03/99→12/02			2	1	U4026	48018
Nexia (95→97)									
1.5	Hbk, Sal	A15MF	04/95→08/97			1	4	U1031	48141
1.5	Hbk, Sal	G15MF	04/95→08/97			1	4	U1031	48141
Nubira (97→02)									
1.6	Est	A16DMS	09/97→12/02	Oval Connector		1	4	U2018	48070
1.6	Est	A16DMS	09/97→12/02	Oval Connector		1	3	U2031	48142
1.6	Sal	A16DMS	09/97→12/02	Oval Connector, To Ch. No.: -580669		1	4	U2018	48070
1.6	Sal	A16DMS	09/97→12/02	Oval Connector, From Ch. No.: -580670		1	3	U2031	48142
1.6, Dual Fuel	Est	A16DMS	03/00→12/02	Oval Connector		1	4	U2018	48070
1.6, Dual Fuel	Est	A16DMS	03/00→12/02	Oval Connector		1	3	U2031	48142
1.6, Dual Fuel	Sal	A16DMS	03/00→12/02	Oval Connector, To Ch. No.: -580669		1	4	U2018	48070
1.6, Dual Fuel	Sal	A16DMS	03/00→12/02	Oval Connector, From Ch. No.: -580670		1	3	U2031	48142
1.6, Dual Fuel	Sal	A16DMS	07/00→12/02	Oval Connector		1	4	U2018	48070
1.6, Dual Fuel	Sal	A16DMS	07/00→12/02	Oval Connector		1	3	U2031	48142
2.0	Est, Sal	X20SED	09/97→12/02	Oval Connector		1	4	U2018	48070
2.0, Dual Fuel	Est, Sal	X20SED	03/00→12/02	Oval Connector		1	4	U2018	48070
Nubira (03→05)									
1.6	Est	A16DM	09/04→01/05			1	4	U2062	48289
1.6	Sal	F16D3	08/03→01/05			1	4	U2062	48289
1.8	Est		09/04→01/05	Oval Connector		1	3	U2031	48142
1.8	Sal	T18SED	08/03→01/05	Oval Connector		1	3	U2031	48142
1.8	Sal	T18SED	08/03→01/05	Oval Connector		1	3	U6035	48318
Tacuma (00→05)									
1.6		A16DMS	10/01→01/05	Oval Connector		1	3	U2031	48142
1.8		A18DMS	09/00→12/01	Oval Connector		1	3	U2031	48142
2.0		X20SED	09/01→01/05	Oval Connector		1	3	U2031	48142

DAIHATSU									
Charade (79→87)									
1.0		CB20, CB22	10/83→12/86			1	3	U1039	48181
1.0		CB20, CB22	10/83→12/86		For Vehicles With Distributor	1	2	U1056	48236
1.0, Turbo		CB60	03/84→03/87		For Vehicles With Distributor	1	2	U1056	48236
Charade (87→93)									
1.0		CB23	05/87→12/92			1	3	U1039	48181
1.0, Turbo		CB61	05/87→06/89			1	3	U1039	48181
1.0, Turbo		CB61	05/87→06/89		For Vehicles With Distributor	1	2	U1056	48236
1.3, Injection		HCE	05/91→12/92			1	3	U1039	48181

LITRE / MODEL	BODY	ENGINE TYPE	DATE	ADDITIONAL INFORMATION	FITMENT INFORMATION	NO. OF COILS	NO. OF PINS	PART NO.	STOCK NO.
DAIHATSU (continued)									
Charade (93→00)									
1.3		HC	06/93→11/99			1	3	U1039	48181
Copen (03→10)									
1.3		K3-VE	03/07→12/10			4	4	U5077	48258
Domino L55									
0.5, 550		AB30	09/81→07/82		For Vehicles With Distributor	1	2	U1056	48236
Domino L60									
0.6		AD10	08/82→09/85		For Vehicles With Distributor	1	2	U1056	48236
Domino L80									
0.8, 850		ED10	11/86→12/88		For Vehicles With Distributor	1	2	U1056	48236
Fourtrak (84→93)									
2.0	ATV/SUV, Van	3Y	02/85→02/92			1	2	U1050	48211
2.0	ATV/SUV, Van	3Y	02/85→02/92		For Vehicles With Distributor	1	2	U1056	48236
Materia (07→10)									
1.5		3SZ-VE	07/07→12/10			4	4	U5077	48258
Mira L201									
0.8, 850		ED10K	02/93→12/94		For Vehicles With Distributor	1	2	U1056	48236
Sirion (05→10)									
1.0		1KR-FE	02/05→12/10			3	4	U5029	48107
1.3		K3-VE	02/05→12/10			4	4	U5077	48258
1.5		3SZ-VE	03/08→12/10			4	4	U5077	48258
Sportrak (89→98)									
1.6, Injection		HD-E	07/90→04/98			1	2	U1050	48211
Terios (06→10)									
1.5		3SZ-VE	05/06→12/10			4	4	U5077	48258

DODGE									
Avenger (07→10)									
2.0		ECN	09/07→04/10			4	3	U5104	48321
2.4		ED3, EDG	09/07→04/10			4	3	U5104	48321
Caliber (06→10)									
1.8		EBA	07/06→10/10			4	3	U5104	48321
2.0		ECN	10/06→10/10			4	3	U5104	48321
Journey (08→11)									
2.4		ED3	01/09→03/11			4	3	U5104	48321
Nitro (07→10)									
3.7		EKG	07/07→12/08			6	2	U5053	48194

FERRARI									
348									
3.4, tb/ts		F119F000	02/90→10/93		For Vehicles Without Distributor	2	3	U2006	48025
F50									
4.7		F130B12	10/95→12/96	Angular Connector		2	4	U2043	48193
F355									
3.5, Berlinetta/GTS	Cpe	F129B/40	09/94→03/99		For Vehicles Without Distributor	2	3	U2006	48025
3.5, Spider	Cnv	F129B/40	09/94→03/99		For Vehicles Without Distributor	2	3	U2006	48025
Mondial									
3.4, t	Cnv, Cpe	F119D	12/89→12/93		For Vehicles Without Distributor	2	3	U2006	48025

LITRE / MODEL	BODY	ENGINE TYPE	DATE	ADDITIONAL INFORMATION	FITMENT INFORMATION	NO. OF COILS	NO. OF PINS	PART NO.	STOCK NO.
FIAT									
126 (77→87)									
0.7		126A1.048	07/81→09/87		For Vehicles With Distributor	1	2	U1079	48342
132 (77→82)									
2.0		132C2.000	01/80→06/81		For Vehicles With Distributor	1	2	U1068	48305
500 312 (08→)									
0.9, TwinAir	Hbk, Cnv	312A2.000	08/10→			2	3	U5156	48411
1.2	Cnv	169A4.000	09/09→			1	6	U6055	49086
1.2	Hbk	169A4.000	01/08→			1	6	U6055	49086
1.4	Cnv	169A3.000	09/09→12/12			4	3	U5018	48061
1.4	Hbk	169A3.000	01/08→12/12			4	3	U5018	48061
Barchetta 183 (95→03)									
1.8		183A1.000, 188A6.000	09/95→07/03			4	3	U5028	48102
1.8		183A1.000, 188A6.000	09/95→07/03			4	3	U5035	48136
Barchetta 183 (03→)									
1.8		183A1.000, 188A6.000	07/03→05/05			4	3	U5028	48102
1.8		183A1.000, 188A6.000	07/03→05/05			4	3	U5035	48136
Brava (95→02)									
1.2, 80		182B2.000	12/98→04/02		For Vehicles Without Distributor	1	3	U2006	48025
1.4		182A3.000	12/95→08/98		For Vehicles Without Distributor	1	3	U2006	48025
1.4		182A3.000	12/95→02/99		For Vehicles Without Distributor	1	3	U2006	48025
1.4		182A3.000	12/95→02/99			4	3	U5018	48061
1.6, 100		182A4.000	02/96→10/01			1	3	U2014	48052
1.8, 115		182A2.000	12/95→10/01			4	3	U5028	48102
1.8, 115		182A2.000	12/95→10/01			4	3	U5035	48136
2.0, 155		182A1.000	03/97→07/98	Angular Connector		5	3	U5047	48168
2.0, 155		182B7.000	02/99→10/01			5	3	U5016	48046
Bravo (07→)									
1.4		192B2.000	06/07→			4	3	U5018	48061
1.4, MultiAir 140		198A7.000	12/10→			4	3	U5018	48061
1.4, T-Jet 120		198A4.000	09/07→			4	3	U5096	48286
1.4, T-Jet 150		198A1.000	09/07→03/11			4	3	U5096	48286
Cinquecento (93→98)									
0.9		1170A1.000, 1170A1.046	05/93→06/98		For Vehicles Without Distributor	2	2	U3001	48013
1.1, Sporting		176B2.000	01/95→01/98		For Vehicles Without Distributor	2	2	U3001	48013
Coupe (95→01)									
2.0, 20v		182A1.000, 182B3.000	11/96→04/98	Angular Connector		4	3	U5047	48168
2.0, 20v		182A1.000, 182B3.000	04/98→08/00			4	3	U5035	48136
2.0, 20v Turbo		175A3.000	11/96→08/00	Angular Connector		5	3	U5047	48168
2.0, Turbo		175A1000	06/95→11/96		For Vehicles Without Distributor	2	2	U3001	48013
Croma (86→93)									
2.0, Carburettor		154A1.000	09/86→01/89			1	4	U1041	48186
2.0, Carburettor			01/91→07/92		For Vehicles With Distributor	1	4	U1025	48121
2.0, Injection		154C3.000	05/91→05/92		For Vehicles Without Distributor	1	3	U2006	48025
2.0, Injection		154C3.046, 834B.146	05/92→07/93		For Vehicles With Distributor	1	4	U1025	48121
2.0, Turbo		154A2.000	05/86→06/90		For Vehicles With Distributor	1	4	U1025	48121
Croma (05→07)									
1.8		939A4.000	03/06→12/07			1	6	U6001	48004
2.2		194A1.000	09/05→05/07			1	9	U6026	48146
Doblo (01→04)									
1.2		223A5.000	06/01→05/04		For Vehicles Without Distributor	2	2	U3001	48013
1.2, Cargo		223A5.000	03/01→05/04		For Vehicles Without Distributor	2	2	U3001	48013
Doblo (04→10)									
1.2		223A5.000	04/04→12/05		For Vehicles Without Distributor	2	2	U3001	48013
1.2, Cargo		223A5.000	04/04→12/05		For Vehicles Without Distributor	2	2	U3001	48013
1.4		350A1.000	01/06→09/10			1	6	U6055	49086
1.4, Cargo		350A1.000	01/06→10/10			1	6	U6055	49086

LITRE / MODEL	BODY	ENGINE TYPE	DATE	ADDITIONAL INFORMATION	FITMENT INFORMATION	NO. OF COILS	NO. OF PINS	PART NO.	STOCK NO.
FIAT (continued)									
Doblo (10→)									
1.4		843A1.000	02/10→			4	3	U5018	48061
1.4, Cargo		843A1.000	02/10→			4	3	U5018	48061
Ducato (86→94)									
2.0		170B	01/86→08/90		For Vehicles With Distributor	1	2	U1076	48339
2.0		170D	02/91→03/94		For Vehicles Without Distributor	1	4	U2009	48030
Ducato (94→02)									
2.0		RFW	06/94→07/95		For Vehicles Without Distributor	1	4	U2009	48030
Ducato (02→07)									
2.0		RFL	05/02→12/05		For Vehicles Without Distributor	1	4	U2009	48030
Fiorino (85→88)									
1.0, 1050		127A.000	01/85→12/87		For Vehicles With Distributor	1	2	U1079	48342
Fiorino (92→01)									
1.4		146C5.000, 146D5.000	09/95→05/01		For Vehicles With Distributor	1	4	U1025	48121
1.4		146C5.000, 146D5.000	09/95→05/01		For Vehicles Without Distributor	1	3	U2006	48025
Grande Punto (06→11)									
1.2		199A4.000	02/06→07/09			1	6	U6055	49086
1.4		199A6.000	05/06→12/10			4	3	U5018	48061
1.4		199A7.000, 350A1.000	02/06→03/11			1	6	U6055	49086
1.4, Abarth		199A8.000	07/08→12/10			4	3	U5096	48286
1.4, Abarth Esseesse		199A8.000	07/08→12/10			4	3	U5096	48286
1.4, T-Jet		198A4.000	09/07→12/10			4	3	U5096	48286
Idea (04→07)									
1.4		843A1.000	02/04→12/07			4	3	U5018	48061
Marea (97→03)									
1.6, 100	Sal	182A4.000	03/97→05/02			1	3	U2014	48052
1.6, 100 Weekend	Est	182A4.000	03/97→05/02			1	3	U2014	48052
1.8, 115	Sal	182A2.000	03/97→05/02			4	3	U5028	48102
1.8, 115	Sal	182A2.000	03/97→05/02			4	3	U5035	48136
1.8, 115 Weekend	Est	182A2.000	03/97→05/02			4	3	U5028	48102
1.8, 115 Weekend	Est	182A2.000	03/97→05/02			4	3	U5035	48136
2.0, 150	Sal	185A8.000	01/01→05/02			5	3	U5016	48046
2.0, 150 Weekend	Est	185A8.000	01/01→05/02			5	3	U5016	48046
2.0, 155	Sal	182B7.000	05/99→12/00			5	3	U5016	48046
2.0, 155 Weekend	Est	182B7.000	05/99→12/00			5	3	U5016	48046
Multipla (99→04)									
1.6, 100		182A4.000	12/99→09/04			1	3	U2014	48052
Multipla (04→11)									
1.6, 100		182B6.000	08/04→12/10			1	3	U2014	48052
Panda (81→95)									
0.8, 750		141B.000, 156A4.000	04/86→12/92		Conventional Coil Ignition (CI), With Distributor	1	2	U1079	48342
0.9		100GL3.000, 146A.000	06/81→06/86		Conventional Coil Ignition (CI), With Distributor	1	2	U1079	48342
0.9		100GL3.000, 146A.000	06/89→12/92		Conventional Coil Ignition (CI), With Distributor	1	2	U1079	48342
1.0		A112B1.054	09/84→04/86		For Vehicles With Distributor	1	2	U1079	48342
1.0, Carburettor		156A2.100	01/86→06/90		Conventional Coil Ignition (CI), With Distributor	1	2	U1079	48342
1.0, Injection		141C2.000, 156A2.246	06/92→07/95		For Vehicles With Distributor	1	4	U1008	48064
1.0, Injection		141C2.000, 156A2.246	06/92→07/95		For Vehicles Without Distributor	2	2	U3001	48013
1.1		156C.046	04/93→07/95		For Vehicles Without Distributor	2	2	U3001	48013
Panda (03→12)									
1.1		187A1.000	11/03→12/09		For Vehicles Without Distributor	2	2	U3001	48013
1.2		188A4.000	11/03→12/09		For Vehicles Without Distributor	2	2	U3001	48013
1.4, 100HP		169A3.000	10/06→12/09			4	3	U5018	48061
Punto (94→01)									
1.1	Van	176B2.000	06/96→02/00		For Vehicles Without Distributor	2	2	U3001	48013

LITRE / MODEL	BODY	ENGINE TYPE	DATE	ADDITIONAL INFORMATION	FITMENT INFORMATION	NO. OF COILS	NO. OF PINS	PART NO.	STOCK NO.
FIAT (continued)									
Punto (94→01)									
1.1, 55	Hbk	176A6.000, 176B2.000	03/94→05/97		For Vehicles Without Distributor	2	2	U3001	48013
1.2, 60	Hbk	176A7.000	03/94→09/99		For Vehicles Without Distributor	2	2	U3001	48013
1.2, 75	Hbk	176A8.000	03/94→03/98		For Vehicles Without Distributor	2	2	U3001	48013
1.2, 85	Cnv	176B9.000	05/97→03/00		For Vehicles Without Distributor	2	2	U3001	48013
1.2, 85	Hbk	176B9.000	03/98→09/99		For Vehicles Without Distributor	2	2	U3001	48013
1.2, Sporting	Hbk	176B9.000	05/97→09/99		For Vehicles Without Distributor	2	2	U3001	48013
1.4, GT	Hbk	176A4.000, 176B6.000	03/94→09/99		For Vehicles Without Distributor	1	3	U2006	48025
1.6, 90	Cnv, Hbk	176A9.000	08/94→04/97		Incl. Control Unit, For Vehicles Without Distributor	1	4	U2004	48012
Punto (99→03)									
1.2		188A4.000	10/99→08/03		For Vehicles Without Distributor	2	2	U3001	48013
1.2		188A5.000	10/99→08/03		For Vehicles Without Distributor	1	3	U2006	48025
1.8		183A1.000, 188A6.000	10/99→08/03			4	3	U5035	48136
Punto (03→07)									
1.2		188A4.000	08/03→07/07		For Vehicles Without Distributor	2	2	U3001	48013
1.2		188A5.000	08/03→05/06		For Vehicles Without Distributor	1	3	U2006	48025
1.4		843A1.000	09/03→05/06			4	3	U5018	48061
1.8		183A1.000, 188A6.000	08/03→05/06			4	3	U5035	48136
Punto Evo (10→12)									
1.2		169A4.000	06/10→02/12			1	6	U6055	49086
1.4		350A1.000	01/10→02/12			1	6	U6055	49086
1.4, MultiAir 105		955A6.000	01/10→02/12			4	3	U5115	48335
Qubo									
1.4		KFT, KFV	12/08→			1	4	U6015	48074
Regata (84→90)									
1.3	Sal	138B2.000	01/84→07/86			1	4	U1030	48137
1.3	Sal	138B2.000	01/84→07/86		For Vehicles With Distributor	1	2	U1079	48342
1.3	Sal	149A3.000, 149A7.000	02/88→07/89			1	4	U1030	48137
1.3	Sal	149A3.000, 149A7.000	02/88→07/89		For Vehicles With Distributor	1	2	U1079	48342
1.5	Sal	138B3.000	01/84→04/85		Electronic Ignition (EI), With Distributor	1	4	U1008	48064
1.5	Sal	138B3.000	01/84→04/85		Conventional Coil Ignition (CI), With Distributor	1	2	U1079	48342
1.6	Est	149C3.000	01/87→02/89		For Vehicles With Distributor	1	2	U1079	48342
1.6	Sal	149A.000	01/84→06/90		For Vehicles With Distributor	1	2	U1079	48342
1.6	Sal	149A2.000, 149A4.000	01/84→09/90		Incl. Control Unit, For Vehicles With Distributor	1	5	U1032	48143
1.6	Sal	149A2.000, 149A4.000	01/84→09/90			1	4	U1041	48186
1.6	Sal	149A2.000, 149A4.000	01/84→09/90		For Vehicles With Distributor	1	2	U1079	48342
Sedici (06→12)									
1.6		M16A	06/06→06/09		For Vehicles Without Distributor	2	3	U4008	48157
1.6, 4x2		M16A	08/08→06/09		For Vehicles Without Distributor	2	3	U4008	48157
Seicento (98→04)									
0.9		1170A1.046	06/98→10/00		For Vehicles Without Distributor	2	2	U3001	48013
1.1		176B2.000, 187A1.000	06/98→03/04		For Vehicles Without Distributor	2	2	U3001	48013
Stilo (01→07)									
1.2	Hbk	188A5.000	02/02→03/04			4	3	U5018	48061
1.4	Hbk	843A1.000	02/04→11/06			4	3	U5018	48061
1.6	Hbk	182B6.000	11/01→10/05			4	3	U5010	48034
1.6, Multiwagon	Est	182B6.000	03/03→12/06			4	3	U5010	48034
1.7, Multiwagon	Est	192A4.000	03/03→04/04			4	3	U5035	48136
1.8	Hbk	192A4.000	11/01→11/06			4	3	U5035	48136
2.4	Hbk	192A2.000	11/01→11/06			5	3	U5048	48172
Strada (79→88)									
1.1	Hbk	138B.000, 138B1.000, 138C1.000, 146A4.048	05/83→12/87		For Vehicles With Distributor	1	2	U1079	48342
1.3	Hbk	138A1.000	01/80→09/82			1	4	U1030	48137
1.3	Hbk	138A1.000	01/80→09/82		For Vehicles With Distributor	1	2	U1068	48305
1.3	Hbk	138A1.000	01/80→09/82		For Vehicles With Distributor	1	2	U1079	48342

LITRE / MODEL	BODY	ENGINE TYPE	DATE	ADDITIONAL INFORMATION	FITMENT INFORMATION	NO. OF COILS	NO. OF PINS	PART NO.	STOCK NO.
FIAT (continued)									
Strada (79→88)									
1.3	Hbk	138B2.000	05/83→04/85			1	4	U1030	48137
1.3	Hbk	138B2.000	05/83→04/85		For Vehicles With Distributor	1	2	U1068	48305
1.3	Hbk	138B2.000	05/83→04/85		For Vehicles With Distributor	1	2	U1079	48342
1.5	Cnv	138A4.000	07/83→04/85			1	4	U1030	48137
1.5	Hbk	138A4.000	12/81→09/82		Electronic Ignition (EI), With Distributor	1	2	U1068	48305
1.5	Hbk	138A4.000	12/81→09/82		Conventional Coil Ignition (CI), With Distributor	1	2	U1079	48342
1.6	Hbk	138AR.000	09/81→12/82			1	4	U1041	48186
2.0, Abarth	Hbk	138AR2.000	06/84→06/87			1	4	U1041	48186
Tempra (90→96)									
1.4	Sal	159A2.000	03/91→07/92		For Vehicles With Distributor	1	4	U1008	48064
1.4	Sal	159A2.000	03/91→07/92		For Vehicles With Distributor	1	4	U1025	48121
1.4	Sal	159A2.000	03/91→07/92		For Vehicles Without Distributor	1	3	U2006	48025
1.6, Carburettor	Est	159A3.000	06/91→06/92		For Vehicles With Distributor	1	4	U1025	48121
1.6, Carburettor	Sal	159A3.000	09/90→06/92		For Vehicles With Distributor	1	4	U1025	48121
1.6, Single Point Injection	Est	159A3.048, 835C1.000	10/92→09/94		For Vehicles With Distributor	1	4	U1025	48121
1.6, Single Point Injection	Est	159A3.048, 835C1.000	10/92→09/94		For Vehicles Without Distributor	1	3	U2006	48025
1.6, Single Point Injection	Sal	159A3.048, 835C1.000	06/92→09/94		For Vehicles With Distributor	1	4	U1025	48121
1.6, Single Point Injection	Sal	159A3.048, 835C1.000	06/92→09/94		For Vehicles Without Distributor	1	3	U2006	48025
Tipo (88→95)									
1.4		160A1.000, 160A1.048	06/88→12/89		For Vehicles With Distributor	1	4	U1008	48064
1.4, ie		160A1.046	03/93→04/95		For Vehicles With Distributor	1	4	U1025	48121
1.4, ie		160A1.046	07/92→03/93		For Vehicles With Distributor	1	4	U1008	48064
1.4, ie		836A4.000	10/93→04/95		For Vehicles Without Distributor	1	3	U2006	48025
1.6		160A2.000	06/88→10/91		For Vehicles With Distributor	1	4	U1025	48121
1.6		160A2.000	06/88→10/91		For Vehicles Without Distributor	1	3	U2006	48025
1.6, ie		159A3.046, 159A3.048, 835C1.000	07/92→04/95		For Vehicles With Distributor	1	4	U1025	48121
1.6, ie		159A3.046, 159A3.048, 835C1.000	07/92→04/95		For Vehicles Without Distributor	1	3	U2006	48025
Ulysse (95→03)									
2.0		RFN	09/00→08/02			1	4	U6009	48032
2.0		RFU(XU10J2C)	10/95→06/00		For Vehicles Without Distributor	1	4	U2009	48030
Ulysse (03→06)									
2.0		RFN(EW10J4)	01/03→09/06			1	4	U6009	48032
Uno (83→95)									
0.9		146A.000, 146A.1000	05/83→06/85		For Vehicles With Distributor	1	2	U1079	48342
1.0, Carburettor		156A2.048, 156A2.100	06/86→09/89			1	4	U1030	48137
1.0, Carburettor		156A2.048, 156A2.100	09/89→12/92		For Vehicles With Distributor	1	4	U1008	48064
1.0, Injection		156A2.246	01/93→07/95		For Vehicles With Distributor	1	4	U1008	48064
1.0, Injection		156A2.246	01/93→07/95		For Vehicles Without Distributor	2	2	U3001	48013
1.1		138B.000	05/83→08/85		Conventional Coil Ignition (CI), With Distributor	1	2	U1079	48342
1.1		146A4.048	08/85→12/88			1	4	U1030	48137
1.1		146A4.048	12/88→08/89		For Vehicles With Distributor	1	4	U1008	48064
1.1, Carburettor		160A3.000	01/90→07/92		For Vehicles With Distributor	1	4	U1008	48064
1.1, Carburettor		160A3.000	01/90→07/92		For Vehicles Without Distributor	2	2	U3001	48013
1.1, Injection		156C.046	07/92→12/93		For Vehicles With Distributor	1	4	U1008	48064
1.1, Injection		156C.046	07/92→12/93		For Vehicles Without Distributor	2	2	U3001	48013
1.3		149A7.000	05/85→08/89		For Vehicles With Distributor	1	2	U1068	48305

FORD

B-MAX (12→)

1.4			10/12→			1	3	U2008	48027
1.6, TI-VC			10/12→			1	3	U2008	48027

LITRE / MODEL	BODY	ENGINE TYPE	DATE	ADDITIONAL INFORMATION	FITMENT INFORMATION	NO. OF COILS	NO. OF PINS	PART NO.	STOCK NO.
FORD (continued)									
Capri MK 3									
1.3			01/80→12/81		Conventional Coil Ignition (CI), With Distributor	1	2	U1063	48300
1.6		LCN	01/80→04/87		Conventional Coil Ignition (CI), With Distributor	1	2	U1063	48300
2.0		NEN, OHCTL20H	01/80→12/85		For Vehicles With Distributor	1	2	U1063	48300
2.8, Injection		PRN	07/81→04/87			1	2	U1070	48307
2.8, Turbo Technics			07/86→12/87		Electronic Ignition (EI)	1	2	U1070	48307
3.0			01/80→12/81		Conventional Coil Ignition (CI), With Distributor	1	2	U1063	48300
C-MAX (07→11)									
1.6		HWDA, HWDB, SHDA, SHDB, SHDC	04/07→05/11			1	3	U2008	48027
1.8		QQDA, QQDB	04/07→05/11			4	2	U5019	48063
1.8, Flexifuel		Q7DA	04/07→05/11			4	2	U5019	48063
2.0		AODA, AODB, AODE, SYDA	04/07→05/11			4	2	U5019	48063
C-MAX (10→16)									
1.0, EcoBoost 100		M1DA, M2DA	09/12→03/16			3	3	U5323	49062
1.6, EcoBoost 150 & 182		JQDB, JTDB	09/12→			1	3	U2008	48027
1.6, EcoBoost 150 & 182		JQDA, JTDA	09/10→03/16			4	3	U5320	49058
1.6, TI-VCT 105		IQDA, IQDB	12/10→			1	3	U2008	48027
1.6, TI-VCT 125		PNDA	12/10→04/13			1	3	U2008	48027
Cortina MK 5									
1.6	Est, Sal	LCJ	01/80→07/82		Conventional Coil Ignition (CI), With Distributor	1	2	U1063	48300
1.6, Ghia	Est		01/80→12/82		Conventional Coil Ignition (CI), With Distributor	1	2	U1063	48300
1.6, Ghia	Sal	LE	01/80→07/82		Conventional Coil Ignition (CI), With Distributor	1	2	U1063	48300
2.0	Est, Sal	NER	01/80→07/82		Conventional Coil Ignition (CI), With Distributor	1	2	U1063	48300
Cougar (98→02)									
2.0		EDBA, EDBB, EDBC, EDBD	10/98→12/01			1	3	U2001	48001
2.5		LCBA	10/98→09/00		For Vehicles Without Distributor	1	4	U2020	48079
2.5		LCBA	09/00→12/01			1	4	U2023	48086
Courier (91→95)									
1.3, Carburettor			10/91→12/92		Electronic Ignition (EI), Without Distributor	1	3	U2005	48021
1.3, CFi			10/91→12/95		Electronic Ignition (EI), Without Distributor	1	3	U2005	48021
Courier (95→02)									
1.3			01/96→12/02		Electronic Ignition (EI)	1	3	U2001	48001
EcoSport (13→)									
1.0, EcoBoost 125 & 140		M1JC	10/13→			3	3	U5323	49062
Escort MK 1 (67→75)									
1.1, 1100	Est		03/68→12/70		For Vehicles With Distributor	1	2	U1065	48302
1.1, 1100	Sal		01/68→12/70		For Vehicles With Distributor	1	2	U1065	48302
1.1, 1100	Van		04/68→12/70		For Vehicles With Distributor	1	2	U1065	48302
1.1, 1100	Est, Sal, Van		01/71→12/75		For Vehicles With Distributor	1	2	U1063	48300
1.3, 1300	Est		03/68→09/70		Conventional Coil Ignition (CI), With Distributor	1	2	U1065	48302
1.3, 1300	Van		04/68→09/70		Conventional Coil Ignition (CI), With Distributor	1	2	U1065	48302
1.3, 1300	Sal	KL13H	06/68→09/70		For Vehicles With Distributor	1	2	U1065	48302
1.3, 1300	Est, Van		10/70→12/75		Conventional Coil Ignition (CI), With Distributor	1	2	U1063	48300
1.3, 1300	Sal	KL13H	10/70→06/71		Conventional Coil Ignition (CI), With Distributor	1	2	U1063	48300
1.3, 1300E/1300GT/Sport	Sal	J3D	06/70→12/75		Conventional Coil Ignition (CI), With Distributor	1	2	U1063	48300

LITRE / MODEL	BODY	ENGINE TYPE	DATE	ADDITIONAL INFORMATION	FITMENT INFORMATION	NO. OF COILS	NO. OF PINS	PART NO.	STOCK NO.
FORD (continued)									
Escort MK 1 (67→75)									
1.6, Mexico	Sal		11/70→12/75		Conventional Coil Ignition (CI), With Distributor	1	2	U1063	48300
1.6, RS1600	Sal		01/70→12/74		Conventional Coil Ignition (CI), With Distributor	1	2	U1063	48300
1.6, Twin Cam	Sal		01/68→12/71		Conventional Coil Ignition (CI), With Distributor	1	2	U1063	48300
2.0, RS2000	Sal		10/73→12/75		For Vehicles With Distributor	1	2	U1063	48300
Escort MK 2 (75→80)									
1.1, 1100	Est	G2	03/75→02/76		For Vehicles With Distributor	1	2	U1065	48302
1.1, 1100	Est	G2	03/75→12/80		Conventional Coil Ignition (CI), With Distributor	1	2	U1063	48300
1.1, 1100	Sal	G2	03/75→08/80		For Vehicles With Distributor	1	2	U1063	48300
1.1, 1100	Van		03/75→12/80		For Vehicles With Distributor	1	2	U1063	48300
1.3, 1300	Est	J2	04/75→08/80		For Vehicles With Distributor	1	2	U1063	48300
1.3, 1300	Sal	J2	03/75→08/80		For Vehicles With Distributor	1	2	U1063	48300
1.3, 1300	Van		03/75→12/80		Conventional Coil Ignition (CI), With Distributor	1	2	U1063	48300
1.3, 1300 Sport/Ghia	Sal	J3	03/75→08/80		For Vehicles With Distributor	1	2	U1063	48300
1.6, 1600	Sal	LC	03/75→08/80		For Vehicles With Distributor	1	2	U1063	48300
1.6, Mexico	Sal		11/75→12/78		Conventional Coil Ignition (CI), With Distributor	1	2	U1063	48300
1.8, RS1800	Sal		06/75→12/77		For Vehicles With Distributor	1	2	U1063	48300
2.0, RS2000	Sal	NE	01/76→08/80		For Vehicles With Distributor	1	2	U1063	48300
Escort MK 3 (80→86)									
1.1	Est, Hbk	GLB, GMA	09/80→08/83		For Vehicles With Distributor	1	2	U1063	48300
1.1	Van	GLB	01/85→02/86		For Vehicles With Distributor	1	2	U1063	48300
1.6	Van		01/85→02/86		Electronic Ignition (EI), Without Distributor	1	3	U2005	48021
Escort MK 4 (86→91)									
1.1	Est	GSG	02/86→09/86		For Vehicles With Distributor	1	2	U1063	48300
1.1	Est, Hbk	GSG	10/86→09/88		For Vehicles With Distributor	1	2	U1077	48340
1.1	Hbk	GSG	10/88→07/90		Electronic Ignition (EI), Without Distributor	1	3	U2005	48021
1.3	Est	JBB, JLA, JLB	02/86→09/88		For Vehicles With Distributor	1	2	U1077	48340
1.3	Van	JBA	07/88→07/90		Electronic Ignition (EI), Without Distributor	1	3	U2005	48021
1.3, HCS	Est, Hbk	JBB, JLA, JLB	10/88→07/90		For Vehicles Without Distributor	1	3	U2005	48021
1.4	Van	F6B, F6D, FUC	10/89→07/90		For Vehicles Without Distributor	1	3	U2005	48021
1.4, Carburettor	Est, Hbk	FUA	10/89→07/90		For Vehicles Without Distributor	1	3	U2005	48021
1.4, CFi	Est, Hbk	F6F, F6G	07/90→01/91		For Vehicles Without Distributor	1	3	U2005	48021
1.6	Cnv	LR2, LRB	10/89→07/90		For Vehicles Without Distributor	1	3	U2005	48021
1.6	Est	L4B	10/89→07/90		For Vehicles Without Distributor	1	3	U2005	48021
1.6	Hbk	L4B	02/86→05/90		For Vehicles Without Distributor	1	3	U2005	48021
Escort MK 5 (90→92)									
1.3	Est	J4B, J6A	09/91→09/92		For Vehicles Without Distributor	1	3	U2005	48021
1.3	Hbk	J4B, J6A	09/90→09/92		For Vehicles Without Distributor	1	3	U2005	48021
1.3	Van	JBD	01/91→12/92		For Vehicles Without Distributor	1	3	U2005	48021
1.3, Catalyst	Van	JBD	12/91→10/92		For Vehicles Without Distributor	1	3	U2005	48021
1.4	Cnv	F6F, F6G	06/92→12/92		For Vehicles Without Distributor	1	3	U2005	48021
1.4	Van		01/91→10/92		Electronic Ignition (EI), Without Distributor	1	3	U2005	48021
1.4, Carburettor	Est, Hbk	F6F, F6G	09/90→07/92		For Vehicles Without Distributor	1	3	U2005	48021
1.4, Catalyst	Van	F6F, F6G	01/91→10/92		For Vehicles Without Distributor	1	3	U2005	48021
1.4, CFi	Est, Hbk	F6F, F6G	09/90→09/92		For Vehicles Without Distributor	1	3	U2005	48021
1.6, Carburettor	Est, Hbk	LUJ, LUK	09/90→07/92		For Vehicles Without Distributor	1	3	U2005	48021
1.6, EFi	Cnv	LJF	09/90→12/92		For Vehicles Without Distributor	1	3	U2005	48021
1.6, EFi	Est, Hbk	LJF	09/90→07/92		For Vehicles Without Distributor	1	3	U2005	48021
2.0, RS 2000	Hbk	N7A	11/91→07/92			2	2	U4005	48119

LITRE / MODEL	BODY	ENGINE TYPE	DATE	ADDITIONAL INFORMATION	FITMENT INFORMATION	NO. OF COILS	NO. OF PINS	PART NO.	STOCK NO.
FORD (continued)									
Escort MK 6 (92→95)									
1.3	Est, Hbk	J4B, J6A	09/92→01/95		For Vehicles Without Distributor	1	3	U2005	48021
1.3, CFi	Van	JBD	10/92→02/94		For Vehicles Without Distributor	1	3	U2005	48021
1.4, Carburettor	Van		10/92→12/93		Electronic Ignition (EI), Without Distributor	1	3	U2005	48021
1.4, Catalyst	Van	F6F, F6G	10/92→12/93		For Vehicles Without Distributor	1	3	U2005	48021
1.4, CFi	Est	F6F, F6G	09/92→01/94		For Vehicles Without Distributor	1	3	U2005	48021
1.4, CFi	Hbk	F6F, F6G	09/92→01/95		For Vehicles Without Distributor	1	3	U2005	48021
1.4, CFi	Sal	F6F, F6G	09/93→04/94		For Vehicles Without Distributor	1	3	U2005	48021
1.4, EFi	Est, Hbk, Sal	F4B, FUH	03/94→01/95		For Vehicles Without Distributor	1	3	U2005	48021
1.6	Cnv	L1E	01/93→01/95		For Vehicles Without Distributor	1	3	U2005	48021
1.6	Est	L1E	09/92→01/95		For Vehicles Without Distributor	1	3	U2005	48021
2.0, RS 2000	Hbk	N7A	09/92→01/95			2	2	U4005	48119
Escort MK 7 (94→02)									
1.3	Est, Hbk	J4B, J6A	01/95→08/98		For Vehicles Without Distributor	1	3	U2005	48021
1.4	Est, Sal	F4B, FUH	01/95→01/99		For Vehicles Without Distributor	1	3	U2005	48021
1.4	Hbk	F4B	01/95→10/98		For Vehicles Without Distributor	1	3	U2005	48021
1.4	Van	F4B	11/97→12/02		For Vehicles Without Distributor	1	3	U2005	48021
1.4, CFi	Est, Sal	F4B, FUH	01/95→01/99		For Vehicles Without Distributor	1	3	U2005	48021
1.4, CFi	Hbk	F4B	01/95→10/98		For Vehicles Without Distributor	1	3	U2005	48021
1.6	Cnv	L1E	02/95→01/99		For Vehicles Without Distributor	1	3	U2005	48021
1.6	Est	L1E	01/95→02/99		For Vehicles Without Distributor	1	3	U2005	48021
1.6	Hbk	L1E	01/95→10/98		For Vehicles Without Distributor	1	3	U2005	48021
1.6	Sal	L1E, L1K	01/95→01/99		For Vehicles Without Distributor	1	3	U2005	48021
1.8	Cnv	RKC	10/95→08/98		For Vehicles Without Distributor	1	3	U2005	48021
1.8	Cnv	RQB	02/95→12/96		For Vehicles Without Distributor	1	3	U2005	48021
1.8	Est, Hbk, Sal	RDA	01/95→08/95		For Vehicles Without Distributor	1	3	U2005	48021
1.8	Est, Sal	RKC	08/96→01/99		For Vehicles Without Distributor	1	3	U2005	48021
1.8	Hbk	RKC	08/96→10/98		For Vehicles Without Distributor	1	3	U2005	48021
2.0, RS 2000	Hbk	N7A	02/95→12/96			2	2	U4005	48119
Explorer (97→02)									
4.0			05/98→12/02			1	4	U2029	48110
Fiesta MK 1 (77→83)									
1.0, 950		TLA	01/80→08/83		For Vehicles With Distributor	1	2	U1063	48300
1.0, 950 Low Compression (LC)		TKA, TKW	01/80→07/83		For Vehicles With Distributor	1	2	U1063	48300
1.1		GLA, GLW	01/80→07/83		For Vehicles With Distributor	1	2	U1063	48300
1.3		J3E	01/80→09/81		Conventional Coil Ignition (CI), With Distributor	1	2	U1063	48300
1.3		J3E	10/81→08/83		Electronic Ignition (EI)	1	2	U1070	48307
1.6, XR2		L3E	12/81→08/83		Electronic Ignition (EI)	1	2	U1070	48307
Fiesta MK 2 (83→89)									
1.0, 950	Hbk	TKB	09/83→09/86		For Vehicles With Distributor	1	2	U1063	48300
1.0, 950	Hbk	TKB	10/86→02/89		For Vehicles With Distributor	1	2	U1077	48340
1.0, 950	Van	TKB	01/85→09/86		Conventional Coil Ignition (CI), With Distributor	1	2	U1063	48300
1.0, 950	Van	TKB	10/86→04/89		Electronic Ignition (EI), With Distributor	1	2	U1077	48340
1.1	Hbk	GLC, GSF	09/83→09/86		For Vehicles With Distributor	1	2	U1063	48300
1.1	Hbk	GLC, GSF	10/86→02/89		For Vehicles With Distributor	1	2	U1077	48340
1.1	Van		01/85→11/86		Conventional Coil Ignition (CI), With Distributor	1	2	U1063	48300
Fiesta MK 3 (89→97)									
1.0	Hbk	TLB	03/89→09/89		Electronic Ignition (EI), With Distributor	1	2	U1077	48340
1.0	Hbk	TLB	10/89→12/91		For Vehicles Without Distributor	1	3	U2005	48021
1.0	Van		04/89→12/91		For Vehicles Without Distributor	1	3	U2005	48021
1.1	Hbk	GUD, GUE	04/89→12/92		For Vehicles With Distributor	1	2	U1077	48340

LITRE / MODEL	BODY	ENGINE TYPE	DATE	ADDITIONAL INFORMATION	FITMENT INFORMATION	NO. OF COILS	NO. OF PINS	PART NO.	STOCK NO.
FORD (continued)									
Fiesta MK 3 (89→97)									
1.1	Hbk	GUD, GUE	04/89→12/92		For Vehicles Without Distributor	1	3	U2005	48021
1.1, Carburettor	Van		04/89→12/92		For Vehicles Without Distributor	1	3	U2005	48021
1.1, CFi	Hbk	G6A	10/90→12/95		For Vehicles Without Distributor	1	3	U2005	48021
1.1, CFi	Van		12/91→12/96		For Vehicles Without Distributor	1	3	U2005	48021
1.3, Carburettor	Van	J6B	12/91→12/92		For Vehicles Without Distributor	1	3	U2005	48021
1.3, CFi	Hbk	J6B	09/91→01/97		For Vehicles Without Distributor	1	3	U2005	48021
1.3, CFi	Van	J6B	12/91→12/92		For Vehicles Without Distributor	1	3	U2005	48021
1.4	Hbk		04/89→12/92		Electronic Ignition (EI), Without Distributor	1	3	U2005	48021
1.4, CFi	Hbk	F6E	02/90→12/92		For Vehicles Without Distributor	1	3	U2005	48021
1.4, CFi	Van		10/90→12/91		For Vehicles Without Distributor	1	3	U2005	48021
1.4, MPi	Hbk		01/94→10/95		For Vehicles Without Distributor	1	3	U2005	48021
1.6	Hbk	L1G	01/94→10/95		For Vehicles Without Distributor	1	3	U2005	48021
1.6	Hbk	LUH	04/89→12/91		For Vehicles Without Distributor	1	3	U2005	48021
1.6, RS Turbo	Hbk	LHA	07/90→07/92		For Vehicles Without Distributor	1	3	U2005	48021
1.6, XR2i	Hbk	LJC	04/89→07/92		For Vehicles Without Distributor	1	3	U2005	48021
1.8, RS 1800	Hbk	RQC	05/92→10/95		For Vehicles Without Distributor	1	3	U2005	48021
1.8, XR2i	Hbk	RDB	05/92→12/94		For Vehicles Without Distributor	1	3	U2005	48021
Fiesta MK 4 (95→99)									
1.25	Hbk	DHA, DHB, DHC, DHD, DHE, DHF, DHG	05/98→10/99			1	3	U2001	48001
1.25	Hbk	DHA, DHB, DHC, DHD, DHE, DHF, DHG	10/95→05/98		For Vehicles Without Distributor	1	3	U2005	48021
1.3	Hbk	J4C, J4J, J4L, J4Q, J4R, J4T	09/98→10/99			1	3	U2001	48001
1.3	Hbk	J4C, J4J, J4L, J4Q, J4R, J4T	10/95→09/98		For Vehicles Without Distributor	1	3	U2005	48021
1.3, Endura E	Van	J4C	10/96→12/98			1	3	U2001	48001
1.4	Hbk	FHA, FHE	05/98→10/99			1	3	U2001	48001
Fiesta MK 5 (99→02)									
1.25		DHA, DHB, DHC, DHD, DHE, DHF, DHG	10/99→01/02			1	3	U2001	48001
1.3		J4C, J4J, J4L, J4Q, J4R, J4T	10/99→01/02			1	3	U2001	48001
1.4		FHA, FHE	10/99→12/00			1	3	U2001	48001
1.6		L1T, L1V	04/00→01/02			1	3	U2001	48001
Fiesta MK 6 (02→09)									
1.25	Hbk	FUJA, FUJB	05/03→08/07			1	3	U2001	48001
1.25	Hbk	FUJA, FUJB	08/07→05/09			1	3	U2008	48027
1.3	Hbk	A9JA, A9JB	01/02→10/03			1	3	U2001	48001
1.3	Van	A9JA, A9JB	12/03→09/08			1	3	U2001	48001
1.4	Hbk	FXJA, FXJB	01/02→02/05			1	3	U2001	48001
1.4	Hbk	FXJA, FXJB	02/05→05/09			1	3	U2008	48027
1.6	Hbk	FYJA, FYJB	01/02→02/05			1	3	U2001	48001
1.6	Hbk	FYJA, FYJB	02/05→05/09			1	3	U2008	48027
2.0, ST	Hbk	N4JB	03/05→05/09			1	3	U2012	48044
Fiesta MK 7 (08→13)									
1.25	Hbk	SNJA, SNJB	10/08→			1	3	U2008	48027
1.25	Hbk	STJA, STJB	10/08→			1	3	U2008	48027
1.25	Van	SNJA, SNJB	03/09→			1	3	U2008	48027
1.4	Hbk	SPJA, SPJC	10/08→			1	3	U2008	48027
1.6	Hbk		01/11→			1	3	U2008	48027
1.6, Ti-VCT	Hbk	HXJA, HXJB	10/08→			1	3	U2008	48027
Fiesta MK 7 (12→)									
1.25		SNJA, SNJB	09/12→			1	3	U2008	48027
1.25		STJA, STJB	09/12→			1	3	U2008	48027
1.0, EcoBoost	Hbk	P4JA	09/12→			3	3	U5323	49062
1.0, EcoBoost 100 & 125	Hbk	M1JE, SFJA	09/12→			3	3	U5323	49062
1.6, ST		JTJA	10/12→			4	3	U5320	49058
Focus C-MAX (03→07)									
1.6		HWDA, HWDB	11/03→03/05			1	3	U2001	48001

LITRE / MODEL	BODY	ENGINE TYPE	DATE	ADDITIONAL INFORMATION	FITMENT INFORMATION	NO. OF COILS	NO. OF PINS	PART NO.	STOCK NO.
FORD (continued)									
Focus C-MAX (03→07)									
1.6		HWDA, HWDB	03/05→03/07			1	3	U2008	48027
1.6 Ti-VCT		HXDA, SIDA	01/05→03/05			1	3	U2001	48001
1.6 Ti-VCT		HXDA, SIDA	03/05→03/07			1	3	U2008	48027
1.8		CSDA, CSDB	11/03→12/04			4	2	U5019	48063
1.8		CSDA, CSDB, Q7DA, QQDA, QQDB	05/04→03/07			4	2	U5019	48063
1.8 Flexifuel		Q7DA	03/06→03/07			4	2	U5019	48063
2.0		AODA, AODB, SYDA	03/04→03/07			4	2	U5019	48063
Focus MK 1 (98→05)									
1.4	Hbk	FXDA, FXDB, FXDC, FXDD	10/98→11/04			1	3	U2001	48001
1.6	Est	FYDA, FYDB, FYDC, FYDD, FYDH	02/99→11/04			1	3	U2001	48001
1.6	Hbk	FYDA, FYDB, FYDC, FYDD, FYDH	10/98→11/04			1	3	U2001	48001
1.6	Sal	FYDA, FYDB, FYDC, FYDD, FYDH	10/00→04/05			1	3	U2001	48001
1.8	Est	EYDB, EYDC, EYDD, EYDE, EYDF, EYDG, EYDI, EYDJ, EYDL	02/99→11/04			1	3	U2001	48001
1.8	Hbk	EYDB, EYDC, EYDD, EYDE, EYDF, EYDG, EYDI, EYDJ, EYDL	10/98→11/04			1	3	U2001	48001
1.8	Sal	EYDB, EYDC, EYDD, EYDE, EYDF, EYDG, EYDI, EYDJ, EYDL	10/00→11/04			1	3	U2001	48001
1.8, Dual Fuel	Hbk	EYDB, EYDC, EYDD, EYDE, EYDF, EYDG, EYDI, EYDJ, EYDL	10/00→12/02			1	3	U2001	48001
2.0	Est, Hbk, Sal	EDDB, EDDC, EDDD, EDDF	10/99→11/04			1	3	U2001	48001
2.0	Est, Sal	EDDB, EDDC, EDDD, EDDF	02/99→10/99			1	3	U2001	48001
2.0	Hbk	EDDB, EDDC, EDDD, EDDF	10/98→10/99			1	3	U2001	48001
2.0, Focus RS	Hbk	HMDA	10/02→12/03			1	3	U2001	48001
2.0, ST170	Est	ALDA	08/02→11/04			1	3	U2001	48001
2.0, ST170	Hbk	ALDA	03/02→11/04			1	3	U2001	48001
Focus MK 2 (05→12)									
1.4	Hbk	ASDA, ASDB	01/05→03/05			1	3	U2001	48001
1.4	Hbk	ASDA, ASDB	03/05→06/10			1	3	U2008	48027
1.6	Est, Hbk	HWDA, HWDB, SHDA	01/05→03/05			1	3	U2001	48001
1.6	Est, Hbk	HWDA, HWDB, SHDA	03/05→03/12			1	3	U2008	48027
1.6	Hbk		11/09→03/11			1	3	U2008	48027
1.6	Sal	HWDA, HWDB, SHDA	04/05→12/07			1	3	U2008	48027
1.6, Coupe Cabriolet	Cnv	HWDA, HWDB	10/06→10/09			1	3	U2008	48027
1.6, Ti-VCT	Est, Hbk	HXDA, HXDB	01/05→03/05			1	3	U2001	48001
1.6, Ti-VCT	Est, Hbk	HXDA, HXDB	03/05→05/08			1	3	U2008	48027
1.6, Ti-VCT	Sal	HXDA, HXDB	04/05→12/07			1	3	U2008	48027
1.8	Est	Q7DA, QQDB	03/06→03/11			4	2	U5019	48063
1.8	Hbk	QQDB	03/06→03/11			4	2	U5019	48063
1.8, Flexifuel	Est, Hbk	Q7DA	03/06→03/11			4	2	U5019	48063
2.0	Est, Hbk	AODA, AODB	01/05→03/12			4	2	U5019	48063
2.0	Sal	AODA, AODB	04/05→12/09			4	2	U5019	48063
2.0, Coupe Cabriolet	Cnv	AODA, AODB	10/06→03/12			4	2	U5019	48063
2.5, RS	Hbk	JZDA	04/09→05/11	Grey Connector housing		5	4	U5037	48140
2.5, RS500	Hbk		05/10→05/11	Grey Connector housing		5	4	U5037	48140
2.5, ST	Hbk	HYDA	10/05→03/11	Grey Connector housing		5	4	U5037	48140
Focus MK 3 (11→15)									
1.0, EcoBoost 100 & 125	Est, Hbk	M1DA, M2DA	02/12→05/15			3	3	U5323	49062
1.6, EcoBoost 150	Est, Hbk	JQDA	02/11→05/15			4	3	U5320	49058
Fusion (02→)									
1.4		FXJA, FXJB, FXJC	03/05→			1	3	U2008	48027
1.4		FXJA, FXJB, FXJC	08/02→02/05			1	3	U2001	48001
1.6		FYJA, FYJB	03/05→			1	3	U2008	48027
1.6		FYJA, FYJB	08/02→02/05			1	3	U2001	48001
Galaxy MK 1 (95→00)									
2.3		E5SA, Y5B	01/97→08/00			2	2	U4005	48119

LITRE / MODEL	BODY	ENGINE TYPE	DATE	ADDITIONAL INFORMATION	FITMENT INFORMATION	NO. OF COILS	NO. OF PINS	PART NO.	STOCK NO.
FORD (continued)									
Galaxy MK 1 (95→00)									
2.8		AAA, AMY	11/95→04/00	Angular Connector	Incl. Control Unit, For Vehicles Without Distributor	1	5	U2024	48087
Galaxy MK 2 (00→06)									
2.3		E5SA, E5SB, Y5B	08/00→05/06			2	2	U4005	48119
2.3		E5SA, E5SB, Y5B	10/02→05/06			1	3	U2001	48001
2.8		AYL	08/00→05/06			6	4	U5011	48035
Galaxy MK 3 (06→11)									
2.0		AOWA, AOWB	05/06→03/11			4	2	U5019	48063
2.3		SEWA	11/07→12/10			4	2	U5091	48279
Galaxy MK 4 (10→16)									
1.6, EcoBoost 160		JTWA	12/10→04/16			4	3	U5320	49058
2.0		AOWA, AOWB	02/10→08/11			4	2	U5019	48063
Granada MK 2 (77→85)									
2.0	Est, Sal	NEP	01/80→02/85			1	2	U1070	48307
2.3	Est, Sal	YYP	01/80→02/85			1	2	U1070	48307
2.8	Est, Sal	PYA	01/80→02/85			1	2	U1070	48307
Granada MK 3 (85→95)									
2.9	Est		05/94→03/95		For Vehicles Without Distributor	1	4	U2020	48079
2.9	Hbk, Sal	BOA	04/91→09/94		For Vehicles Without Distributor	1	4	U2020	48079
Grand C-MAX (10→16)									
1.0, EcoBoost 100 & 120		M1DA, M2DA	02/12→05/15			3	3	U5323	49062
1.6, EcoBoost 150 & 182		JQDB, JTDB	09/12→			1	3	U2008	48027
1.6, EcoBoost 150 & 182		JQDA, JTDA	09/10→03/16			4	3	U5320	49058
Grand C-MAX (10→)									
1.6, TI-VCT 125		PNDA	12/10→04/13			1	3	U2008	48027
Ka MK 1 (96→09)									
1.3	Hbk	A9A, A9B	08/02→07/07			1	3	U2001	48001
1.3	Hbk	A9A, A9B	07/07→11/08			1	3	U2008	48027
1.3	Hbk	BAA, J4D, J4K, J4M, J4N, J4P, J4S	09/96→09/98		For Vehicles Without Distributor	1	3	U2005	48021
1.3	Hbk	BAA, J4D, J4K, J4M, J4N, J4P, J4S	09/98→06/03			1	3	U2001	48001
1.3	Van		09/02→03/04			1	3	U2001	48001
Ka MK 2 (08→)									
1.2		FP4	11/08→			1	6	U6055	49086
Kuga (08→)									
2.5		HYDB	03/09→	Grey Connector housing		5	4	U5037	48140
Maverick (93→99)									
2.4		KA-24	09/96→04/98	Oval Connector		1	2	U1024	48117
2.4		KA24-E	07/93→07/96	Oval Connector		1	2	U1024	48117
Maverick (01→04)									
2.0		YF	04/01→03/04			1	3	U2001	48001
3.0		AJ	04/01→03/04			6	2	U5089	48276
Mondeo MK 1 (93→96)									
2.5	Est	SEA	02/95→08/96		For Vehicles Without Distributor	1	4	U2020	48079
2.5	Hbk, Sal	SEA	10/94→08/96		For Vehicles Without Distributor	1	4	U2020	48079
Mondeo MK 2 (96→00)									
1.6	Hbk	L1J	05/98→10/00			1	3	U2001	48001
1.6	Sal	L1J	08/98→07/99			1	3	U2001	48001
1.8	Est, Hbk, Sal	RKB, RKF, RKH, RKJ, RKK	08/98→10/00			1	3	U2001	48001
2.0	Est, Hbk, Sal	NGA, NGB, NGC, NGD	08/98→10/00			1	3	U2001	48001
2.5	Est, Hbk, Sal	SEA	09/96→10/00		For Vehicles Without Distributor	1	4	U2020	48079
2.5, ST-200	Est, Hbk, Sal		01/99→10/00		For Vehicles Without Distributor	1	4	U2020	48079

LITRE / MODEL	BODY	ENGINE TYPE	DATE	ADDITIONAL INFORMATION	FITMENT INFORMATION	NO. OF COILS	NO. OF PINS	PART NO.	STOCK NO.
FORD (continued)									
Mondeo MK 3 (00→07)									
1.8	Est, Hbk, Sal	CHBA, CHBB	03/05→08/07			1	3	U2012	48044
1.8	Est, Hbk, Sal	CHBA, CHBB	11/00→02/05			1	3	U2001	48001
1.8, SCi	Est, Hbk, Sal	CFBA	07/03→08/07			4	3	U5050	48177
2.0	Est, Hbk, Sal	CJBA, CJBB	03/05→08/07			1	3	U2012	48044
2.0	Est, Hbk, Sal	CJBA, CJBB	11/00→02/05			1	3	U2001	48001
2.5	Est, Hbk, Sal		10/00→10/07			1	4	U2023	48086
3.0	Est, Hbk, Sal	REBA	01/05→08/07			1	4	U2023	48086
3.0, ST220	Est, Hbk	MEBA	01/05→08/07			1	4	U2023	48086
3.0, ST220	Est, Hbk, Sal	MEBA	05/02→01/05			1	4	U2023	48086
3.0, ST220	Sal		01/05→10/07			1	4	U2023	48086
Mondeo MK 4 (07→15)									
1.6, EcoBoost 160	Est, Hbk, Sal	JTBA	09/10→12/15			4	3	U5320	49058
1.6, Ti-VCT 110	Est	RHBA	06/07→08/10			1	3	U2008	48027
1.6, Ti-VCT 110	Hbk	RHBA	06/07→12/10			1	3	U2008	48027
1.6, Ti-VCT 120	Hbk		12/10→			1	3	U2008	48027
1.6, Ti-VCT 125	Est	PNBA	06/07→08/10			1	3	U2008	48027
1.6, Ti-VCT 125	Hbk	PNBA	06/07→03/11			1	3	U2008	48027
1.6, Ti-VCT 125	Sal	PNBA	06/07→04/09			1	3	U2008	48027
2.0	Est, Hbk	AOBA, AOBC	06/07→12/12			4	2	U5019	48063
2.0	Sal	AOBA, AOBC	06/07→12/10			4	2	U5019	48063
2.0, Flexifuel	Est, Hbk	TBBA, TBBB	11/07→03/11			4	2	U5019	48063
2.3	Est, Hbk	SEBA	07/07→12/10			4	2	U5091	48279
2.3	Sal	SEBA	07/07→04/09			4	2	U5091	48279
2.5, T	Est, Hbk, Sal	HUBA	06/07→12/10	Grey Connector housing		5	4	U5037	48140
Mondeo MK 5 (14→)									
1.0, EcoBoost	Est, Hbk	M1CB	03/15→			3	3	U5323	49062
Orion MK 2 (86→90)									
1.3		JBB, JLA, JLB	02/86→09/88		For Vehicles With Distributor	1	2	U1077	48340
1.3, HCS		JBB, JLA, JLB	09/88→07/90		For Vehicles With Distributor	1	2	U1077	48340
1.4, CFi			02/90→10/90		For Vehicles Without Distributor	1	3	U2005	48021
Orion MK 3 (90→92)									
1.3		J4B, J6A	09/90→12/91		For Vehicles Without Distributor	1	3	U2005	48021
1.4		FUH	09/90→12/92		For Vehicles Without Distributor	1	3	U2005	48021
1.4, CFi		FUH	09/90→07/92		For Vehicles Without Distributor	1	3	U2005	48021
1.6			04/92→07/92		For Vehicles Without Distributor	1	3	U2005	48021
1.6, Carburettor		LUJ, LUK	09/90→12/92		For Vehicles Without Distributor	1	3	U2005	48021
1.6, Injection		LJF	09/90→09/92		For Vehicles Without Distributor	1	3	U2005	48021
1.8			02/92→07/92		For Vehicles Without Distributor	1	3	U2005	48021
Orion MK 3 Facelift (92→93)									
1.4		FUH	07/92→12/93		For Vehicles Without Distributor	1	3	U2005	48021
P100 (82→87)									
1.6			01/85→12/87		For Vehicles With Distributor	1	2	U1063	48300
Puma (97→03)									
1.4		FHD, FHF	02/98→10/00			1	3	U2001	48001
1.6		L1W	10/00→03/03			1	3	U2001	48001
1.7		MHA, MHB	06/97→03/03			1	3	U2001	48001
1.7, Racing			10/99→12/00			1	3	U2001	48001

LITRE / MODEL	BODY	ENGINE TYPE	DATE	ADDITIONAL INFORMATION	FITMENT INFORMATION	NO. OF COILS	NO. OF PINS	PART NO.	STOCK NO.
FORD (continued)									
Scorpio (95→98)									
2.0	Est, Sal	N3A	01/95→08/96			2	2	U4005	48119
2.3	Est, Sal	Y5A	08/96→07/98			2	2	U4005	48119
2.9	Est, Sal	BOB	01/95→07/98		For Vehicles Without Distributor	1	4	U2020	48079
Sierra MK 1 (82→87)									
1.3	Hbk	JCT	10/82→10/86		For Vehicles With Distributor	1	2	U1063	48300
1.6	Est	LCS, LCT, LSD	12/82→09/84		For Vehicles With Distributor	1	2	U1063	48300
1.6	Est, Hbk	LCS, LCT, LSD	09/84→12/86		For Vehicles With Distributor	1	2	U1063	48300
1.6	Hbk	LCS, LCT, LSD	10/82→09/84		For Vehicles With Distributor	1	2	U1063	48300
Sierra MK 2 (87→93)									
1.6	Est, Hbk	LSE	03/87→12/91		For Vehicles Without Distributor	1	3	U2005	48021
1.6, CFi	Est, Hbk	L6B	10/91→02/93		For Vehicles Without Distributor	1	3	U2005	48021
1.6, Sapphire	Sal	LSE	03/87→12/91		For Vehicles Without Distributor	1	3	U2005	48021
1.6, Sapphire CFi	Sal	L6B	10/91→02/93		For Vehicles Without Distributor	1	3	U2005	48021
1.8, CFi	Est, Hbk	R2C, R6A	01/92→02/93		For Vehicles Without Distributor	1	3	U2005	48021
1.8, CVH	Est, Hbk	R2C, R6A	05/88→12/92		For Vehicles Without Distributor	1	3	U2005	48021
1.8, Sapphire CFi	Sal	R2C, R6A	01/92→02/93		For Vehicles Without Distributor	1	3	U2005	48021
1.8, Sapphire CVH	Sal	R2C, R6A	05/88→12/92		For Vehicles Without Distributor	1	3	U2005	48021
S-MAX (06→16)									
1.6, EcoBoost 160		JTBA	09/10→04/16			4	3	U5320	49058
2.0		AOWA, AOWB	05/06→03/12			4	2	U5019	48063
2.0, Flexifuel		TBWA, TBWB	11/07→03/11			4	2	U5019	48063
2.3		SEWA	11/07→12/10			4	2	U5091	48279
2.5		HUWA	05/06→12/10	Grey Connector housing		5	4	U5037	48140
SportKa MK 1 (96→09)									
1.6	Hbk	CDB, CDC	07/03→07/07			1	3	U2001	48001
1.6	Hbk	CDB, CDC	07/07→11/08			1	3	U2008	48027
StreetKa MK 1 (96→09)									
1.6	Cnv	CDRA, CDRB	05/03→07/05			1	3	U2001	48001
Tourneo Connect (13→)									
1.0, EcoBoost 100		M2GA	10/13→			3	3	U5323	49062
Transit Connect (02→09)									
1.8		EYPA, EYPC, EYPD	08/02→12/06			1	3	U2001	48001
1.8, Dual Fuel		EYPC	07/03→12/06			1	3	U2001	48001
Transit Connect (13→)									
1.0, EcoBoost 100		M2GA	10/13→			3	3	U5323	49062
Transit Courier (14→)									
1.0, EcoBoost 100		SFCA	03/14→			3	3	U5323	49062
Transit MK 6 (00→06)									
2.3		E5FA, E5FC	04/01→05/06			2	2	U4005	48119
2.3, Dual Fuel		E5FA, E5FC	03/02→05/06			2	2	U4005	48119
Transit MK 7 (06→)									
2.3			06/06→03/12			4	2	U5019	48063

FSO									
Polonez									
1.5		AA	01/80→04/84		For Vehicles With Distributor	1	2	U1079	48342

HONDA									
Accord MK 4 (89→94)									
2.0, Carburettor	Sal	F20A2, F20A3	01/90→03/93			1	2	U1015	48097
2.0, Injection	Cpe	F20A7	04/92→09/93		For Vehicles With Distributor	1	2	U1004	48054
2.0, Injection	Sal	F20A4, F20A8	01/90→03/93		For Vehicles With Distributor	1	2	U1004	48054
2.2	Sal	F22A3	01/90→03/93		For Vehicles With Distributor	1	2	U1004	48054
2.2	Sal	F22A3	01/90→03/93			1	4	U1075	48324
2.2, Aerodeck	Est	F22A7	04/91→12/93		For Vehicles With Distributor	1	2	U1004	48054

LITRE / MODEL	BODY	ENGINE TYPE	DATE	ADDITIONAL INFORMATION	FITMENT INFORMATION	NO. OF COILS	NO. OF PINS	PART NO.	STOCK NO.
HONDA (continued)									
Accord MK 5 (93→98)									
1.8	Sal	F18A3	03/96→08/98		For Vehicles With Distributor	1	2	U1020	48111
2.0	Cpe	F20B3	06/94→12/97		For Vehicles With Distributor	1	2	U1004	48054
2.0	Sal	F20Z1	02/96→08/98		For Vehicles With Distributor	1	2	U1020	48111
2.0	Sal	F20Z1	05/93→01/96		For Vehicles With Distributor	1	2	U1004	48054
2.0	Sal	F20Z2	02/94→01/96		For Vehicles With Distributor	1	2	U1004	48054
2.0, Aerodeck	Est	F20B3	06/94→11/97		For Vehicles With Distributor	1	2	U1004	48054
2.2	Cpe	F22B5	06/94→12/97		For Vehicles With Distributor	1	2	U1004	48054
2.2, Aerodeck	Est	F22B5	06/94→12/97		For Vehicles With Distributor	1	2	U1004	48054
2.2, Vtec	Sal	F22Z2	03/96→08/98		For Vehicles With Distributor	1	2	U1020	48111
2.3	Sal	H23A3	10/93→01/96		For Vehicles With Distributor	1	2	U1004	48054
Accord MK 6 (98→03)									
1.8	Sal	F18B2	10/98→06/99		For Vehicles With Distributor	1	2	U1020	48111
1.8, Vtec	Hbk	F18B2	12/99→12/02		For Vehicles With Distributor	1	2	U1020	48111
1.8, Vtec	Sal	F18B2	06/99→12/02		For Vehicles With Distributor	1	2	U1020	48111
2.0	Cpe	F20B5, F20B7	07/98→12/01		For Vehicles With Distributor	1	2	U1004	48054
2.0	Hbk	F20B6	12/99→12/02		For Vehicles With Distributor	1	2	U1004	48054
2.0	Hbk	F20B6	12/99→12/02			1	2	U1015	48097
2.0	Hbk	F20B6	12/99→12/02		For Vehicles With Distributor	1	2	U1020	48111
2.0	Sal	F20B6	10/98→01/01		For Vehicles With Distributor	1	2	U1004	48054
2.0	Sal	F20B6	10/98→01/01			1	2	U1015	48097
2.0	Sal	F20B6	10/98→01/01		For Vehicles With Distributor	1	2	U1020	48111
2.2	Sal	H22A7	02/99→12/02		For Vehicles With Distributor	1	2	U1004	48054
2.3	Hbk	F23Z5	11/00→12/02		For Vehicles With Distributor	1	2	U1020	48111
2.3	Sal	F23A1, F23Z5	01/01→04/03		For Vehicles With Distributor	1	2	U1020	48111
3.0	Cpe	J30A1	07/98→12/01		For Vehicles Without Distributor	6	3	U5051	48179
Accord MK 7 (03→08)									
2.0, VTEC	Est	K20A6	05/03→12/05			4	3	U5064	48231
2.0, VTEC	Sal	K20A6	02/03→12/05			4	3	U5064	48231
2.4, VTEC	Est	K24A	05/03→09/08			4	3	U5064	48231
2.4, VTEC	Sal	K24A, K24A3	02/03→09/08			4	3	U5064	48231
Accord MK 8 (08→)									
2.0, i-VTEC	Est, Sal	R20A3	07/08→			4	3	U5081	48266
Civic CRX (84→92)									
1.6		D16A8	10/87→12/89			1	2	U1017	48099
1.6, VT		B16A1	07/90→07/92			1	2	U1017	48099
Civic CRX (92→97)									
1.6, ESi		D16Y6	06/92→02/96		For Vehicles With Distributor	1	2	U1004	48054
1.6, ESi		D16Y8	02/96→02/98		For Vehicles With Distributor	1	2	U1004	48054
1.6, VTi		B16A2	06/92→02/95		For Vehicles With Distributor	1	2	U1004	48054
Civic MK 3 (84→87)									
1.3		EV2	02/84→10/87			1	2	U1015	48097
Civic MK 4 (87→91)									
1.3		D13B1, D13B2	10/87→09/91			1	2	U1015	48097
1.4		D14A1	10/87→12/89			1	2	U1015	48097
Civic MK 5 (91→95)									
1.3	Hbk	D13B2	12/91→11/95			1	2	U1015	48097
1.5	Cpe	D15B7	02/94→11/95		For Vehicles With Distributor	1	2	U1004	48054
1.5	Hbk	D15B2, D15Z2, D15Z3	11/91→07/96		For Vehicles With Distributor	1	2	U1004	48054
1.5	Sal	D15B2, D15Z1	11/91→11/95		For Vehicles With Distributor	1	2	U1004	48054
1.6	Hbk	B16A2	11/91→11/95			1	2	U1017	48099
1.6	Hbk	D16Z6	11/91→11/95		For Vehicles With Distributor	1	2	U1004	48054
1.6	Sal	B16A2	11/91→11/95		For Vehicles With Distributor	1	2	U1004	48054
1.6	Sal	D16Z6, D16Z7	11/91→11/95		For Vehicles With Distributor	1	2	U1004	48054
Civic MK 6 (95→01)									
1.4	Hbk	D14A4, D14Z2	11/95→02/01		For Vehicles With Distributor	1	2	U1004	48054
1.5	Hbk	D15Z6	01/96→11/99		For Vehicles With Distributor	1	2	U1004	48054
1.5	Sal	D15Z6	01/96→09/98		For Vehicles With Distributor	1	2	U1004	48054

LITRE / MODEL	BODY	ENGINE TYPE	DATE	ADDITIONAL INFORMATION	FITMENT INFORMATION	NO. OF COILS	NO. OF PINS	PART NO.	STOCK NO.
HONDA (continued)									
Civic MK 6 (95→01)									
1.5, Aerodeck	Est	D15Z8	04/98→02/99		For Vehicles With Distributor	1	2	U1004	48054
1.5, Aerodeck	Est	D15Z8	04/98→02/99		For Vehicles With Distributor	1	2	U1020	48111
1.5, Vtec	Hbk	D15Z6	11/99→12/00		For Vehicles With Distributor	1	2	U1004	48054
1.6	Hbk	D16B2	05/97→02/99		For Vehicles With Distributor	1	2	U1004	48054
1.6	Hbk	D16Y5	11/95→11/99		For Vehicles With Distributor	1	2	U1020	48111
1.6, Aerodeck	Est	D16B2	04/98→11/99		For Vehicles With Distributor	1	2	U1004	48054
1.6, Vtec	Cpe	D16Y8	03/96→01/99		For Vehicles With Distributor	1	2	U1004	48054
1.6, Vtec	Hbk	D16W4	11/99→10/00		For Vehicles With Distributor	1	2	U1020	48111
1.6, VTi	Cpe, Hbk	B16A2	04/99→12/00		For Vehicles With Distributor	1	2	U1004	48054
1.6, VTi	Hbk, Sal	B16A2	01/96→02/01		For Vehicles With Distributor	1	2	U1004	48054
1.8, Aerodeck VTi	Est	B18C4	04/98→02/01		For Vehicles With Distributor	1	2	U1004	48054
Civic MK 7 (00→06)									
1.4	Hbk	D14Z5, D14Z6	02/01→09/05		For Vehicles Without Distributor	4	3	U5051	48179
1.6	Hbk	D16V1	02/01→09/05		For Vehicles Without Distributor	4	3	U5051	48179
1.7, Vtec	Cpe	D17A5, D17A9	05/01→09/03		For Vehicles Without Distributor	4	3	U5051	48179
2.0, Type-R	Hbk	K20A2	09/01→09/05			4	3	U5099	48295
2.0, Type-S	Hbk	K20A3	01/04→09/05			4	3	U5099	48295
Civic MK 8 (06→12)									
1.4, i-VTEC		L13Z1	11/08→12/12			4	3	U5134	49073
2.0, Type-R		K20Z4	03/07→06/11			4	3	U5099	48295
Civic MK 9 (12→)									
1.4, i-VTEC		L13Z1	11/08→12/12			4	3	U5134	49073
Concerto (89→94)									
1.4	Hbk	D14A1, D14A8	10/89→10/91			1	2	U1015	48097
1.5	Hbk	D15B2	01/92→12/94			1	2	U1017	48099
1.6	Hbk	D16A8	10/91→12/94			1	2	U1017	48099
1.6	Hbk	D16Z2	10/89→12/91			1	2	U1017	48099
1.6	Hbk	D16Z2	10/89→12/94			1	2	U1016	48098
1.6	Sal	D16Z2	06/90→12/91			1	2	U1016	48098
1.6	Sal	D16Z2	06/90→12/91			1	2	U1017	48099
CR-V MK 1 (97→02)									
2.0		B20B	06/97→01/99		For Vehicles With Distributor	1	2	U1004	48054
2.0		B20Z1	03/99→02/02		For Vehicles With Distributor	1	2	U1004	48054
CR-V MK 2 (02→07)									
2.0		K20A4	07/02→09/06			4	3	U5099	48295
CR-V MK 3 (06→)									
2.0		R20A2	01/07→04/10			4	3	U5099	48295
2.0, i-VTEC		R20A2	01/10→			4	3	U5099	48295
CR-Z (08→)									
1.5		LEA1, LEA3	04/10→			4	3	U5134	49073
FR-V (04→10)									
1.7, VTEC		D17A2	11/04→10/07		For Vehicles Without Distributor	4	3	U5051	48179
1.8, VTEC		R18A1	06/07→06/10			4	3	U5081	48266
2.0, VTEC		K20A9	02/05→12/06			4	3	U5099	48295
HR-V (99→06)									
1.6		D16W1	03/99→01/05		For Vehicles With Distributor	1	2	U1004	48054
1.6, Vtec		D16W5	01/00→07/06		For Vehicles With Distributor	1	2	U1004	48054
Integra (98→01)									
1.8, Type-R		B18C6	01/98→10/01		For Vehicles With Distributor	1	2	U1004	48054
Jazz MK 2 (02→09)									
1.2, i-DSi		L12A1	10/04→04/09			4	3	U5097	48292
1.2, i-DSi		L12A1	10/04→04/09			4	3	U5098	48293
1.4, i-DSi		L13A1	03/02→07/08			4	3	U5097	48292
1.4, i-DSi		L13A1	03/02→07/08			4	3	U5098	48293
Jazz MK 3 (08→)									
1.2		L12B1	10/08→			4	3	U5134	49073

LITRE / MODEL	BODY	ENGINE TYPE	DATE	ADDITIONAL INFORMATION	FITMENT INFORMATION	NO. OF COILS	NO. OF PINS	PART NO.	STOCK NO.
HONDA (continued)									
Jazz MK 3 (08→)									
1.4		L13Z1	10/08→			4	3	U5134	49073
1.4		LDA3	04/11→12/15			4	3	U5225	49070
Legend (06→09)									
3.5		C35A8	07/06→12/09		For Vehicles Without Distributor	6	3	U5051	48179
Logo (00→01)									
1.3		D13B7	03/00→12/01		For Vehicles With Distributor	1	2	U1004	48054
Prelude (83→92)									
2.0		B20A4	10/87→01/92		For Vehicles With Distributor	1	2	U1004	48054
2.0, 4WS		B20A7	10/87→12/90		For Vehicles With Distributor	1	2	U1004	48054
2.0, Injection		B20A1	04/86→07/87		For Vehicles With Distributor	1	2	U1004	48054
Prelude (92→97)									
2.0		F20A4	04/92→09/96		For Vehicles With Distributor	1	2	U1004	48054
2.2		H22A2	02/93→09/96		For Vehicles With Distributor	1	2	U1004	48054
2.3		H23A2	04/92→09/96		For Vehicles With Distributor	1	2	U1004	48054
Prelude (97→01)									
2.0		F20A4	02/97→10/00		For Vehicles With Distributor	1	2	U1004	48054
2.2		H22A5	02/97→10/00		For Vehicles With Distributor	1	2	U1004	48054
S2000 (99→09)									
2.0		F20CVTEC	09/99→12/09			4	3	U5099	48295
Shuttle (95→00)									
2.2		F22B8	07/95→02/98		For Vehicles With Distributor	1	2	U1004	48054
2.3		F23A7	02/98→10/00		For Vehicles With Distributor	1	2	U1004	48054
2.3		F23A7	02/98→10/00		For Vehicles With Distributor	1	2	U1020	48111
Stream (01→05)									
1.7		D17A2	05/01→09/03		For Vehicles Without Distributor	4	3	U5051	48179
2.0		K20A1	05/01→12/05			4	3	U5099	48295

HYUNDAI									
Accent (94→00)									
1.3	Cpe	G4EA	01/00→12/00	With Bracket		1	2	U2048	48209
1.3	Cpe	G4EH	10/94→01/00	With Bracket		1	2	U1022	48113
1.3	Cpe	G4EH, G4EHR	10/94→01/00	With Bracket	Coupling Type DIN	1	3	U2040	48173
1.3	Hbk	G4EH	04/99→01/00	With Bracket		1	2	U1022	48113
1.3	Hbk	G4EH	04/99→01/00	With Bracket	Coupling Type DIN	1	3	U2040	48173
1.3	Sal	G4EH	10/94→05/99	With Bracket		1	2	U1022	48113
1.3	Sal	G4EH	10/94→05/99	With Bracket	Coupling Type DIN	1	3	U2040	48173
1.5	Hbk, Sal	G4EK	10/94→05/99	With Bracket		1	2	U1022	48113
1.5	Hbk, Sal, Cpe	G4EK	10/94→05/99	With Bracket	Coupling Type DIN	1	3	U2040	48173
1.5, MVi	Cpe	G4ER	01/97→01/00	With Bracket		1	2	U1022	48113
1.5, MVi	Cpe	G4ER	01/97→01/00			1	3	U2059	48272
Accent (00→03)									
1.3		G4EA	01/00→03/03	With Bracket		1	2	U2048	48209
1.5		G4EB	01/00→03/03	With Bracket		1	5	U2060	48287
1.5, MVi		G4EC-G	09/00→03/03	With Bracket		1	5	U2060	48287
Accent (03→06)									
1.3	Hbk		02/03→11/05	With Bracket		1	2	U2048	48209
1.6	Hbk	G4ED-G	02/03→11/05	With Bracket		1	5	U2060	48287
1.6	Sal	G4ED-G	02/03→03/04	With Bracket		1	5	U2060	48287
Accent (06→10)									
1.4		G4EE	07/06→03/10			4	2	U5073	48247
Amica (00→03)									
1.0		G4HC	02/00→08/00	With Bracket	Incl. Control Unit, For Vehicles With Distributor	1	2	U1037	48176
1.0		G4HC	09/00→03/03	With Bracket	For Vehicles Without Distributor	1	3	U2039	48170

LITRE / MODEL	BODY	ENGINE TYPE	DATE	ADDITIONAL INFORMATION	FITMENT INFORMATION	NO. OF COILS	NO. OF PINS	PART NO.	STOCK NO.
HYUNDAI (continued)									
Atoz (98→01)									
1.0		G4HC	08/99→08/00	With Bracket	Incl. Control Unit, For Vehicles With Distributor	1	2	U1037	48176
1.0		G4HC	09/00→12/01	With Bracket	For Vehicles Without Distributor	1	3	U2039	48170
Coupe (96→02)									
1.6		4G61	06/97→01/00	With Bracket		1	3	U2035	48160
1.6		G4GR	01/00→05/01	With Bracket		1	3	U2035	48160
2.0		G4DF	01/00→12/01	With Bracket		1	3	U2035	48160
2.0		G4GF	09/96→01/00	With Bracket		1	3	U2035	48160
Coupe (02→05)									
1.6		G4ED-G	03/02→02/05	With Bracket		1	5	U2060	48287
2.0		G4GC-G	01/02→03/07	With Bracket	Coupling Type DIN	1	5	U2036	48166
2.7		G6BA-G	03/02→02/05	With Bracket		1	4	U2052	48249
Coupe (05→07)									
1.6		G4ED-G	01/05→03/07	With Bracket		1	5	U2060	48287
2.0		G4GC-G	01/05→03/07	With Bracket		1	5	U2036	48166
2.7		G6BA-G	01/05→03/07	With Bracket		1	4	U2052	48249
Coupe SIII (07→09)									
1.6		G4ED-G	01/07→08/09	With Bracket		1	5	U2060	48287
2.0		G4GC-G	01/07→12/09	With Bracket	Coupling Type DIN	1	5	U2036	48166
Elantra (01→06)									
1.6	Hbk	G4ED-G	03/01→05/04	With Bracket		1	5	U2060	48287
1.6	Sal	G4ED-G	03/01→06/04	With Bracket		1	5	U2060	48287
2.0	Hbk	G4GC, G4GC-G	03/01→05/04	With Bracket		1	3	U2051	48230
2.0	Hbk, Sal	G4GC, G4GC-G	03/01→05/04	With Bracket	Coupling Type DIN	1	5	U2036	48166
Getz (02→05)									
1.1		G4HD	10/02→09/05	Triangular Connector, With Bracket		1	3	U2066	48315
1.3		G4EA	10/02→09/05	With Bracket		1	2	U2048	48209
1.6			10/02→11/05	With Bracket		1	5	U2060	48287
Getz (05→09)									
1.1		G4HD	10/05→05/09	Triangular Connector, With Bracket		1	3	U2066	48315
1.4		G4EE	10/05→05/09	With Bracket		1	3	U2035	48160
Grandeur (06→09)									
3.3		G6DB	06/06→12/09			6	2	U5087	48274
i10 (08→11)									
1.1		G4HG	03/08→03/11	With Bracket		1	3	U2063	48290
i10 (10→14)									
1.0		G3LA	12/10→08/14			3	2	U5316	49054
i20 (09→12)									
1.4		G4FA	01/09→12/12			4	2	U5067	48239
i20 (12→)									
1.2		G4LA	04/12→06/14			4	2	U5310	49048
1.4		G4FA	04/12→			4	2	U5067	48239
i30 (07→13)									
1.4	Est	G4FA	03/10→06/12			4	2	U5067	48239
1.4	Est	G4FA	03/10→06/12			4	2	U5072	48245
1.4	Hbk	G4FA	10/07→11/11			4	2	U5072	48245
1.4	Hbk	G4FA-I	01/12→05/12			4	2	U5067	48239
1.6	Est	G4FC	02/08→06/12			4	2	U5067	48239
1.6	Hbk	G4FC	10/07→11/08			4	2	U5072	48245
1.6	Hbk	G4FC	11/08→11/11			4	2	U5067	48239
i30 (12→)									
1.6			06/12→			4	2	U5067	48239
i30 (15→)									
1.6	Est, Hbk	G4FD	02/15→			4	2	U5317	49055
i35 (10→16)									
1.6	Est, Hbk	G4FD	09/10→12/15			4	2	U5317	49055

LITRE / MODEL	BODY	ENGINE TYPE	DATE	ADDITIONAL INFORMATION	FITMENT INFORMATION	NO. OF COILS	NO. OF PINS	PART NO.	STOCK NO.
HYUNDAI (continued)									
i35 (10→16)									
2.0		G4KD	01/10→12/10			4	2	U5314	49052
i40 (11→)									
1.6	Est, Hbk	G4FD	12/11→12/13			4	2	U5317	49055
Lantra (91→95)									
1.5		G4DJJE	10/93→12/95	With Bracket		1	2	U1022	48113
1.6		G4CR	06/91→11/95	With Bracket	For Vehicles Without Distributor	1	4	U2042	48189
1.8		G4CN	10/93→11/95	With Bracket	For Vehicles Without Distributor	1	4	U2042	48189
Lantra (95→98)									
1.6	Est	4G61	11/95→06/98	With Bracket		1	2	U1022	48113
1.6	Est	G4GR	11/95→09/97	With Bracket		1	3	U2035	48160
1.6	Sal	4G61	11/95→06/98	With Bracket		1	3	U2035	48160
1.8	Est	G4GM	02/96→02/97		For Vehicles With Distributor	1	2	U1004	48054
1.8	Est	G4GM	02/96→02/97	With Bracket		1	3	U2035	48160
1.8	Sal	G4GM	11/95→02/97		For Vehicles With Distributor	1	2	U1004	48054
1.8	Sal	G4GM	11/95→02/97	With Bracket		1	3	U2035	48160
2.0	Sal	G4GF	02/97→06/98	With Bracket		1	3	U2035	48160
Lantra (98→01)									
1.6	Est	4G61	06/98→10/00	With Bracket		1	3	U2035	48160
1.6	Sal	4G61	06/98→09/00	With Bracket		1	3	U2035	48160
2.0	Est	G4GF	06/98→10/00	With Bracket		1	3	U2035	48160
2.0	Sal	G4GF	06/98→09/00	With Bracket		1	3	U2035	48160
Matrix (01→11)									
1.6		G4ED-G	10/01→08/10	With Bracket		1	5	U2060	48287
1.8		G4GB, G4GB-G	10/01→03/08	With Bracket	Coupling Type DIN	1	5	U2036	48166
1.8		G4GB-G	10/01→03/08	With Bracket		1	3	U2051	48230
Pony (85→91)									
1.3, X1	Hbk, Sal	G13B	10/85→09/89	With Bracket		1	2	U1022	48113
1.3, X1	Hbk, Sal	G13B	10/85→09/89		For Vehicles With Distributor	1	2	U1068	48305
1.5, X1	Sal	G15B, G4DJ	10/85→09/89	With Bracket		1	2	U1022	48113
1.5, X1	Sal	G15B, G4DJ	10/85→09/89		For Vehicles With Distributor	1	2	U1068	48305
Pony (90→94)									
1.3, X2	Hbk	G4DG	10/92→12/94	With Bracket		1	2	U1022	48113
1.3, X2	Hbk	G4DG	10/92→12/94		For Vehicles With Distributor	1	2	U1068	48305
1.3, X2	Sal	G4DG	12/92→09/94	With Bracket		1	2	U1022	48113
1.3, X2	Sal	G4DG	12/92→09/94		For Vehicles With Distributor	1	2	U1068	48305
1.5, X2	Hbk	G15B, G4DJ	09/90→12/94	With Bracket		1	2	U1022	48113
1.5, X2	Hbk	G15B, G4DJ	09/90→12/94		For Vehicles With Distributor	1	2	U1068	48305
1.5, X2	Hbk	G15B, G4DJ	09/90→12/94			1	2	U1084	48357
1.5, X2	Sal	G15B, G4DJ	09/90→12/93	With Bracket		1	2	U1022	48113
1.5, X2	Sal	G15B, G4DJ	09/90→12/93		For Vehicles With Distributor	1	2	U1068	48305
1.5, X2	Sal	G15B, G4DJ	09/90→12/93			1	2	U1084	48357
Santa Fe (01→06)									
2.4		G4JS-G	03/01→11/05			2	3	U4006	48134
2.7		G6BA-G	03/01→05/01	With Bracket		1	4	U2052	48249
2.7		G6BA-G	11/05→05/06			3	3	U5074	48252
Santa Fe (06→10)									
2.7		G6EA	04/06→12/06	With Bracket		1	4	U2052	48249
2.7		G6EA	04/06→09/06			3	3	U5074	48252
2.7		G6EA	09/06→09/09			3	2	U5088	48275
S Coupe (90→96)									
1.5, MVi		G4EK	10/92→10/95	With Bracket		1	2	U1022	48113
1.5, MVTi		G4EK-TC	10/92→03/95	With Bracket		1	2	U1022	48113
Sonata (89→93)									
1.8		4G62	07/89→12/92	With Bracket	For Vehicles With Distributor	1	2	U1034	48152
2.0		G4CP, G4CP-U	07/89→06/92	With Bracket	For Vehicles With Distributor	1	2	U1034	48152
2.0		G4CP-D	06/92→10/93	With Bracket	For Vehicles With Distributor	1	2	U1034	48152

LITRE / MODEL	BODY	ENGINE TYPE	DATE	ADDITIONAL INFORMATION	FITMENT INFORMATION	NO. OF COILS	NO. OF PINS	PART NO.	STOCK NO.
HYUNDAI (continued)									
Sonata (94→98)									
2.0		G4CP-D	01/94→09/96	With Bracket	For Vehicles Without Distributor	1	4	U2042	48189
2.0		G4CP-DM	09/96→06/98	With Bracket	For Vehicles With Distributor	1	2	U1034	48152
3.0		G6AT	10/94→06/98	With Bracket	For Vehicles With Distributor	1	2	U1034	48152
Sonata (98→02)									
2.0		G4JP-G	06/98→10/01			2	3	U4006	48134
2.5		G6BVG	06/98→12/01			1	4	U2076	48371
Sonata (02→05)									
2.0		G4JP-EG	01/02→11/04			2	3	U4006	48134
2.7		G6BAG	01/02→07/05			1	4	U2076	48371
Sonata (05→11)									
2.0			07/06→03/10			4	2	U5087	48274
2.4		G4KC	01/05→12/10			4	2	U5314	49052
3.3		G6DB	07/06→05/09			6	2	U5087	48274
Stellar (84→91)									
1.6		G32B	06/84→12/91		For Vehicles With Distributor	1	2	U1056	48236
1.6		G32B	06/84→12/91		For Vehicles With Distributor	1	2	U1068	48305
Trajet (00→07)									
2.0		G4JP-G	06/00→02/04			2	3	U4006	48134
2.0		G4JP-G	02/04→09/04	With Bracket		1	3	U2051	48230
2.0		G4GC-G	06/04→12/07			2	3	U4006	48134
2.7		G6BAG	01/01→09/04			1	4	U2076	48371
Tucson (04→10)									
2.0		G4GC	08/04→03/10	With Bracket		1	3	U2051	48230
2.7		G6BAG	08/04→12/08			1	4	U2077	48372
XG30 (00→04)									
3.0		G6CT-G	03/00→11/02			3	3	U4023	48314
3.0		G6CT-G	11/02→06/03			3	3	U4022	48313

INFINITI									
FX50 (09→)									
5.0		VK50VE	04/09→			6	3	U5119	48347

ISUZU									
Trooper									
3.2		6VD1	03/92→04/98			3	2	U3015	48218

JAGUAR/DAIMLER									
Daimler Super V8 X308 (97→02)									
4.0		DC	09/97→04/03			8	2	U5038	48144
4.0		DC	09/97→04/03		For Vehicles Without Distributor	8	2	U5045	48164
4.0		DC	09/97→04/03			8	4	U5102	48319
Daimler V8 X308 (97→02)									
4.0		BC	09/97→12/02			8	2	U5038	48144
4.0		BC	09/97→12/02		For Vehicles Without Distributor	8	2	U5045	48164
4.0		BC	09/97→12/02			8	4	U5102	48319
E Type Series 1									
3.8, FHC	Cpe		04/61→07/64		For Vehicles With Distributor	1	2	U1061	48298
3.8, OTS	Cnv		04/61→07/64		For Vehicles With Distributor	1	2	U1061	48298
4.2, FHC	Cpe		05/64→09/68		For Vehicles With Distributor	1	2	U1079	48342
4.2, FHC 2+2	Cpe		06/66→09/68		For Vehicles With Distributor	1	2	U1079	48342
4.2, OTS	Cnv		05/64→09/68		For Vehicles With Distributor	1	2	U1079	48342
E Type Series 1½									
4.2, FHC	Cpe		01/68→12/69		For Vehicles With Distributor	1	2	U1079	48342
4.2, FHC 2+2	Cpe		01/68→09/68		For Vehicles With Distributor	1	2	U1079	48342

LITRE / MODEL	BODY	ENGINE TYPE	DATE	ADDITIONAL INFORMATION	FITMENT INFORMATION	NO. OF COILS	NO. OF PINS	PART NO.	STOCK NO.
JAGUAR/DAIMLER (continued)									
E Type Series 1½									
4.2, OTS	Cnv		01/68→09/68		For Vehicles With Distributor	1	2	U1079	48342
4.2, OTS	Cnv		10/68→12/69		Conventional Coil Ignition (CI), With Distributor	1	2	U1056	48236
E Type Series 2									
4.2, FHC	Cpe		01/69→12/70		For Vehicles With Distributor	1	2	U1079	48342
4.2, FHC 2+2	Cpe		01/69→12/70		For Vehicles With Distributor	1	2	U1079	48342
4.2, OTS	Cnv		01/69→12/70		Conventional Coil Ignition (CI), With Distributor	1	2	U1056	48236
S Type (98→08)									
2.5			04/02→11/05			6	4	U5083	48268
3.0		AJ-V6	01/99→06/02	To Ch. No.: M45254		6	2	U5031	48120
3.0		AJ-V6	07/02→10/07	From Ch. No.: M45255		6	4	U5083	48268
4.0		AJ-V8	01/99→04/02	To Ch. No.: M45254		8	2	U5038	48144
4.0		AJ-V8	01/99→04/02	From Ch. No.: M45255		8	4	U5082	48267
4.2			04/02→04/07	To Ch. No.: M45254		8	2	U5038	48144
4.2			04/02→04/07	From Ch. No.: M45255		8	4	U5082	48267
4.2, R Supercharged			04/02→10/07	To Ch. No.: M45254		8	2	U5038	48144
4.2, R Supercharged			04/02→10/07	From Ch. No.: M45255		8	4	U5082	48267
XF									
3.0		AJ6WG	03/08→04/11			6	4	U5083	48268
4.2		SV82G	03/08→08/09			8	4	U5082	48267
4.2, SV8		SV8TS	03/08→08/09			8	4	U5082	48267
XJ6 Series 3 (79→92)									
3.4		XK3.4(82-86)	01/80→10/86		For Vehicles With Distributor	1	2	U1056	48236
4.2		XK4.2(82-87)	01/80→12/86		For Vehicles With Distributor	1	2	U1056	48236
XJ6 X300 (94→97)									
3.2		9JPGRB	11/94→07/97	From Ch. No.: 720125, To Ch. No.: 812255	For Vehicles Without Distributor	6	2	U5045	48164
3.2, LWB		9JPGRB	07/95→07/97	From Ch. No.: 720125, To Ch. No.: 812255	For Vehicles Without Distributor	6	2	U5045	48164
4.0		9JPFRB	11/94→07/97	From Ch. No.: 720125, To Ch. No.: 812255	For Vehicles Without Distributor	6	2	U5045	48164
4.0, LWB Sovereign		9JPFRB	07/95→07/97	From Ch. No.: 720125, To Ch. No.: 812255	For Vehicles Without Distributor	6	2	U5045	48164
4.0 Sovereign		9JPFRB	11/94→07/97	From Ch. No.: 720125, To Ch. No.: 812255	For Vehicles Without Distributor	6	2	U5045	48164
XJ6 X350 (03→08)									
3.0		AJ-V6	05/03→05/08			6	4	U5083	48268
XJ6 X350 (X358) (07→10)									
3.0		AJ-V6	05/07→03/09			6	4	U5083	48268
XJ6 XJ40 (86→94)									
2.9		AJ6(2.9)	10/86→08/90		For Vehicles With Distributor	1	2	U1076	48339
2.9 Sovereign		AJ6(2.9)	10/86→08/90		For Vehicles With Distributor	1	2	U1076	48339
XJ8 X308 (97→02)									
3.2			09/97→12/02	From Ch. No.: F20645		8	2	U5038	48144
3.2			09/97→12/02	From Ch. No.: 853936		8	4	U5102	48319
3.2			09/97→12/02	To Ch. No.: 853935		8	2	U5103	48320
4.0		BC	09/97→12/02	From Ch. No.: F20645		8	2	U5038	48144
4.0		BC	09/97→12/02	From Ch. No.: 853936		8	4	U5102	48319
4.0		BC	09/97→12/02	To Ch. No.: 853935		8	2	U5103	48320
4.0 Sovereign		BC	07/00→12/02			8	2	U5038	48144
XJ8 X350 (03→08)									
3.5			05/03→04/07			8	4	U5082	48267
3.5 LWB			09/04→12/05			8	4	U5082	48267
4.2			05/03→05/08			8	4	U5082	48267
4.2, LWB			09/04→05/08			8	4	U5082	48267
4.2, Super V8			05/03→05/08			8	4	U5082	48267
4.2, Super V8 LWB			09/04→06/07			8	4	U5082	48267

LITRE / MODEL	BODY	ENGINE TYPE	DATE	ADDITIONAL INFORMATION	FITMENT INFORMATION	NO. OF COILS	NO. OF PINS	PART NO.	STOCK NO.
JAGUAR/DAIMLER (continued)									
XJ8 X350 (X358) (07→10)									
4.2			05/07→03/09			8	4	U5082	48267
4.2, LWB			05/07→03/09			8	4	U5082	48267
4.2, Super V8			05/07→03/09			8	4	U5082	48267
XJ12 Series 3 (79→92)									
5.3		7P	09/89→12/92		For Vehicles With Distributor	1	4	U1047	48200
XJ12 X300 (94→97)									
6.0		8E	11/94→09/96		For Vehicles Without Distributor	2	4	U2020	48079
6.0, LWB		8E	07/95→09/96		For Vehicles Without Distributor	2	4	U2020	48079
XJR (94→97)									
4.0, Supercharged		9KPDRB	11/94→07/97	From Ch. No.: 720125, To Ch. No.: 812255	For Vehicles Without Distributor	6	2	U5045	48164
XJR (97→02)									
4.0, Supercharged		DC	09/97→12/02	From Ch. No.: F20646		8	2	U5038	48144
4.0, Supercharged		DC	09/97→12/02	From Ch. No.: 853935, To Ch. No.: F20645		8	4	U5102	48319
4.0, Supercharged		DC	09/97→12/02	To Ch. No.: 853935		8	2	U5103	48320
XJR X350 (03→08)									
4.2, Supercharged			05/03→05/08			8	4	U5082	48267
XJR X350 (X358) (07→10)									
4.2, Supercharged			05/07→03/09			8	4	U5082	48267
XJS (75→96)									
4.0	Cnv, Cpe	9LPFRB	07/94→03/96	From Ch. No.: 179737, To Ch. No.: 226645	For Vehicles Without Distributor	6	2	U5045	48164
5.3	Cpe		01/80→07/81	From Ch. No.: 179737, To Ch. No.: 226645	For Vehicles With Distributor	1	4	U1047	48200
5.3, Catalyst	Cpe	V12(90-93, 211KW)	09/90→05/92	From Ch. No.: 179737, To Ch. No.: 226645	For Vehicles With Distributor	1	4	U1047	48200
5.3, Catalyst	Cpe	V12(90-93, 211KW)	09/90→05/92		For Vehicles With Distributor	1	2	U1073	48310
5.3, HE	Cpe	V12(82-90)	07/81→12/87	From Ch. No.: 179737, To Ch. No.: 226645	For Vehicles With Distributor	1	4	U1047	48200
5.3, HE	Cpe	V12(82-90)	07/81→12/87		For Vehicles With Distributor	1	2	U1073	48310
6.0	Cnv, Cpe		09/94→12/95	From Ch. No.: 179737, To Ch. No.: 226645	For Vehicles With Distributor	1	4	U1047	48200
XK8 (96→08)									
4.0	Cnv, Cpe	CC, CE	10/96→09/02			8	4	U5102	48319
4.0	Cnv, Cpe	CC, CE	10/96→09/02			8	2	U5103	48320
4.2	Cnv, Cpe		09/02→07/05			8	4	U5082	48267
XK8 (06→)									
4.2	Cnv, Cpe		03/06→06/09			8	4	U5082	48267
4.2 XK60	Cnv, Cpe		07/08→06/09			8	4	U5082	48267
XKR (96→08)									
4.2, Supercharged	Cnv, Cpe		09/02→07/05			8	4	U5082	48267
XKR (06→)									
4.2, S	Cpe		02/08→06/09			8	4	U5082	48267
4.2, Supercharged	Cpe		06/06→06/09			8	4	U5082	48267
4.2, Supercharged	Cnv		08/07→06/09			8	4	U5082	48267
X Type (01→10)									
2.0	Sal		03/02→10/05			6	4	U5083	48268
2.0	Est		10/04→11/05			6	4	U5083	48268
2.5	Est		03/04→04/08			6	4	U5083	48268
2.5	Sal		06/01→04/08			6	4	U5083	48268
3.0	Est		03/04→06/04			6	4	U5083	48268
3.0	Sal	AJ-V6	06/01→09/07			6	4	U5083	48268
3.0	Est	AJ-V6	06/04→12/09			6	4	U5083	48268

LITRE / MODEL	BODY	ENGINE TYPE	DATE	ADDITIONAL INFORMATION	FITMENT INFORMATION	NO. OF COILS	NO. OF PINS	PART NO.	STOCK NO.
JEEP									
Cherokee (93→01)									
2.5		EPE	04/97→01/01		For Vehicles With Distributor	1	2	U1085	48203
2.5			01/93→04/97	Oval Connector	Not Incl. Control Unit, For Vehicles With Distributor	1	2	U1086	48204
4.0		MX	01/93→11/95		Incl. Control Unit, For Vehicles With Distributor	1	5	U1032	48143
4.0		MX	01/93→11/95	Oval Connector	Not Incl. Control Unit, For Vehicles With Distributor	1	2	U1086	48204
4.0		S01	11/95→04/97	Oval Connector	Not Incl. Control Unit, For Vehicles With Distributor	1	2	U1086	48204
4.0			07/98→09/98	Oval Connector	Not Incl. Control Unit, For Vehicles With Distributor	1	2	U1086	48204
4.0			09/98→09/01		For Vehicles With Distributor	1	2	U1085	48203
Cherokee (01→05)									
2.4		ED1	01/02→02/05		For Vehicles Without Distributor	1	3	U2044	48195
3.7		EKG	08/03→02/05			6	2	U5053	48194
Cherokee (05→08)									
2.4		ED1	01/05→08/06		For Vehicles Without Distributor	1	3	U2044	48195
3.7		EKG	01/05→10/07			6	2	U5053	48194
Commander (06→10)									
5.7, Hemi		EZB	03/06→10/07			8	3	U5121	48265
Compass (07→10)									
2.4		ERZ	04/07→12/10			4	3	U5104	48321
Compass (11→)									
2.0		ECN	07/11→			4	3	U5104	48321
2.4		ERZ	07/11→			4	3	U5104	48321
Grand Cherokee (94→99)									
4.0		S01	01/96→12/97	Oval Connector	Not Incl. Control Unit, For Vehicles With Distributor	1	2	U1086	48204
4.0		S01	01/98→03/99		For Vehicles With Distributor	1	2	U1085	48203
5.2		Y01	01/98→04/99		For Vehicles With Distributor	1	2	U1085	48203
5.2		Y01	10/95→12/97	Oval Connector	Not Incl. Control Unit, For Vehicles With Distributor	1	2	U1086	48204
5.9			10/97→04/99		For Vehicles With Distributor	1	2	U1085	48203
Grand Cherokee (99→05)									
4.0			04/99→09/99		For Vehicles Without Distributor	1	4	U6032	48219
4.7		EVA	04/99→08/00			8	2	U5053	48194
4.7, Overland		EVC	11/01→07/05			8	2	U5053	48194
Grand Cherokee (05→11)									
4.7		EVA	06/05→08/06			8	2	U5053	48194
5.7, Hemi		EZB	01/06→07/07			8	3	U5121	48265
5.7, Hemi		EZB	06/05→12/05			8	2	U4017	48264
6.1, SRT-8		ESF	07/06→12/10			8	3	U5121	48265
Patriot									
2.4		ED3	01/08→03/12			4	3	U5104	48321
Wrangler									
2.5		EPE	01/93→08/96	Oval Connector	Not Incl. Control Unit, For Vehicles With Distributor	1	2	U1086	48204
2.5		P00	01/98→01/01		For Vehicles With Distributor	1	2	U1085	48203
2.5		P00	03/97→12/97	Oval Connector	Not Incl. Control Unit, For Vehicles With Distributor	1	2	U1086	48204
3.8		EGT	04/07→12/10	Oval Connector		1	4	U2057	48260
4.0		ERH	01/93→11/95	Oval Connector	Not Incl. Control Unit, For Vehicles With Distributor	1	2	U1086	48204
4.0		S01	01/98→12/00		For Vehicles With Distributor	1	2	U1085	48203
4.0		S01	08/96→12/97	Oval Connector	Not Incl. Control Unit, For Vehicles With Distributor	1	2	U1086	48204

LITRE / MODEL	BODY	ENGINE TYPE	DATE	ADDITIONAL INFORMATION	FITMENT INFORMATION	NO. OF COILS	NO. OF PINS	PART NO.	STOCK NO.
KIA									
Carens (00→06)									
1.8		T8	11/00→07/02		For Vehicles Without Distributor	2	2	U4021	48294
1.8			10/02→04/05		For Vehicles Without Distributor	2	2	U4021	48294
Carens (06→13)									
1.6		G4FC	08/09→			4	2	U5067	48239
2.0		G4KA	09/06→03/11			4	2	U5087	48274
Carens (13→)									
1.6		G4FD	04/13→			4	2	U5317	49055
Ceed (07→13)									
1.4	Hbk	G4FA	01/07→03/10			4	2	U5072	48245
1.4	Hbk	G4FA-L	06/10→03/13			4	2	U5072	48245
1.6	Est	G4FC	09/07→03/13			4	2	U5072	48245
1.6	Hbk	G4FC	02/08→03/13			4	2	U5072	48245
Ceed (12→)									
1.6		G4FD	04/12→04/16			4	2	U5317	49055
Cerato (04→07)									
1.6	Hbk	G4ED	09/04→08/07	With Bracket		1	5	U2060	48287
1.6	Sal	G4ED	08/04→08/07	With Bracket		1	5	U2060	48287
2.0	Sal	G4GC	05/05→08/07	With Bracket		1	3	U2051	48230
Clarus (99→01)									
1.8		T8	06/99→06/01		For Vehicles Without Distributor	2	2	U4021	48294
Magentis (01→06)									
2.0		G4JP	01/03→06/06			2	3	U4006	48134
2.5		201B, G6BV	06/01→03/04			1	4	U2076	48371
Magentis (06→12)									
2.7		G6EA	06/06→06/09			3	3	U5074	48252
Mentor (94→01)									
1.5	Hbk	B5	06/96→06/99		For Vehicles With Distributor	1	2	U1059	48253
1.5	Hbk	B5	06/96→06/99		For Vehicles Without Distributor	2	2	U4019	48270
1.5	Sal	B5	06/96→10/97		For Vehicles With Distributor	1	2	U1059	48253
1.5	Sal	B5	06/96→10/97		For Vehicles Without Distributor	2	2	U4019	48270
1.6	Sal	B6	06/94→06/99		For Vehicles With Distributor	1	2	U1059	48253
1.6	Sal	B6	06/94→06/99		For Vehicles Without Distributor	2	2	U4021	48294
Mentor MK 2 (94→01)									
1.5			06/99→06/01		For Vehicles Without Distributor	2	2	U4019	48270
Picanto (04→11)									
1.0		G4HE	09/05→12/11	With Bracket		1	3	U2063	48290
1.1		G4HG	05/04→12/11	With Bracket		1	3	U2063	48290
Picanto (11→)									
1.0		G3LA	05/11→04/16			3	2	U5316	49054
1.2		G4LA	04/12→06/14			4	2	U5310	49048
Pro Ceed (08→13)									
1.4		G4FA	02/08→04/10			4	2	U5067	48239
1.6		G4FC	02/08→12/13			4	2	U5067	48239
Pro Ceed (12→)									
1.6		G4FD	04/12→04/16			4	2	U5317	49055
Rio (01→05)									
1.3			07/01→02/05	With Bracket		1	3	U2064	48296
1.5			07/01→03/04	With Bracket		1	5	U2061	48288
Rio (05→11)									
1.4	Hbk, Sal	G4EE	07/05→12/11		For Engines With Variable Valve Timing	4	2	U5073	48247
1.6, Sport		G4ED	06/08→03/10	For OE No.: 27301-26600		1	5	U2060	48287
1.6, Sport		G4ED	06/08→03/10	For OE No.: 27301-26640	For Engines With Variable Valve Timing	4	2	U5073	48247
Rio (11→)									
1.2		G4LA	09/11→			4	2	U5310	49048
1.3		G4LA	09/11→			4	2	U5310	49048

LITRE / MODEL	BODY	ENGINE TYPE	DATE	ADDITIONAL INFORMATION	FITMENT INFORMATION	NO. OF COILS	NO. OF PINS	PART NO.	STOCK NO.
KIA (continued)									
Rio (11→)									
1.4		G4FA	09/11→			4	2	U5067	48239
Sedona (99→06)									
2.5		K5	10/01→10/06			1	7	U2054	48251
2.5			09/99→10/01			1	7	U2054	48251
Sedona (06→)									
2.7		G6EA	01/07→03/10			6	2	U5088	48275
Shuma (99→02)									
1.5			06/99→02/01		For Vehicles With Distributor	1	2	U1059	48253
1.5			06/99→02/01		For Vehicles Without Distributor	2	2	U4019	48270
1.6		GA6D	02/01→04/01	With Bracket		1	5	U2061	48288
1.8		T8	06/99→02/01		For Vehicles Without Distributor	2	2	U4021	48294
Shuma MK 2 (02→04)									
1.6		GA6D	03/02→03/04	With Bracket		1	5	U2061	48288
1.8		T8	04/03→03/04		For Vehicles Without Distributor	2	2	U4021	48294
Sorento (06→10)									
3.3		G6DB	11/07→12/09			6	2	U5087	48274
Sorento (10→)									
2.4		G4KE	01/10→03/11			4	2	U5087	48274
2.4		G4KE	04/11→10/15			4	2	U5314	49052
Soul (09→15)									
1.6		G4FC	02/09→07/11			4	2	U5067	48239
1.6		G4FD	09/11→04/15			4	2	U5317	49055
Soul (14→)									
1.6		G4FD	04/14→			4	2	U5317	49055
Sportage (95→99)									
2.0		FE(16V)	07/95→06/99		For Vehicles Without Distributor	1	3	U2006	48025
2.0		FE(16V)	07/95→06/99			2	2	U4020	48291
Sportage (99→04)									
2.0		FE(16V)	02/03→03/04			2	2	U4020	48291
2.0		FE(16V)	06/99→02/03		For Vehicles Without Distributor	1	3	U2006	48025
2.0		FE(16V)	06/99→02/03			2	2	U4020	48291
Sportage (05→10)									
2.0		G4GC	01/05→06/07	With Bracket		1	3	U2051	48230
2.0		G4GC	11/07→12/10	With Bracket		1	3	U2075	48370
2.7		G6BA	01/05→10/08			1	4	U2077	48372
Sportage (10→16)									
2.0		G4KD	06/10→09/14			4	2	U5314	49052
Sportage (16→)									
1.6		G4FD	01/16→			4	2	U5317	49055
Venga (09→)									
1.4		G4FA	11/09→			4	2	U5067	48239
1.6		G4FC	11/09→			4	2	U5067	48239

LADA									
1500									
1.5		BA32103	01/80→06/85		For Vehicles With Distributor	1	2	U1079	48342
1600									
1.6		BA32106	01/80→04/84		For Vehicles With Distributor	1	2	U1079	48342
Niva									
1.6		BA32121	01/80→05/87		For Vehicles With Distributor	1	2	U1079	48342
Riva									
1.2	Sal	BA32101	05/83→02/90		For Vehicles With Distributor	1	2	U1079	48342
1.3	Est	BA32105	10/85→12/90		For Vehicles With Distributor	1	2	U1079	48342
1.3	Sal	BA32105	05/83→12/91		For Vehicles With Distributor	1	2	U1079	48342
1.5, E	Sal	BA32103	01/92→12/97		For Vehicles With Distributor	1	2	U1079	48342

LITRE / MODEL	BODY	ENGINE TYPE	DATE	ADDITIONAL INFORMATION	FITMENT INFORMATION	NO. OF COILS	NO. OF PINS	PART NO.	STOCK NO.
LADA (continued)									
Riva									
1.5, L	Sal	BA32103	01/92→12/93		For Vehicles With Distributor	1	2	U1079	48342
Samara									
1.1	Hbk	BA321081	07/90→12/94		For Vehicles With Distributor	1	2	U1076	48339
1.3	Hbk	BA32108	11/87→12/94		For Vehicles With Distributor	1	2	U1076	48339
1.3	Sal	BA32108	07/92→07/97		For Vehicles With Distributor	1	2	U1076	48339
1.3	Sal	BA32108	07/92→07/97		For Vehicles With Distributor	1	2	U1079	48342
1.5	Hbk	BA321083	10/88→12/97		For Vehicles With Distributor	1	2	U1076	48339
1.5	Sal	BA321083	07/92→12/97		For Vehicles With Distributor	1	2	U1076	48339

LAMBORGHINI									
Diablo (91→99)									
5.7			03/90→06/98		For Vehicles Without Distributor	6	2	U3001	48013
5.7, SE30			06/94→07/95		For Vehicles Without Distributor	6	2	U3001	48013
5.7, VT			03/93→08/98		For Vehicles Without Distributor	6	2	U3001	48013
Gallardo (03→)									
5.0	Cpe	L510	08/03→03/06			10	4	U5014	48041
5.0	Cpe		03/06→12/09			10	4	U5014	48041
5.0, Spyder	Cnv		03/06→12/09			10	4	U5014	48041
5.0, Superleggera	Cpe		03/07→12/09			10	4	U5014	48041

LANCIA									
Dedra									
1.6		835A1.000	03/90→06/94		For Vehicles Without Distributor	1	3	U2006	48025
Delta									
1.5		831A1.000, 831B1.000	07/80→03/84			1	4	U1041	48186
2.0, HF Integrale Evoluzione		831E5.000, 831E5.046	08/93→01/94		For Vehicles Without Distributor	2	2	U3001	48013
Prisma									
1.5		831A1.000	05/83→10/85			1	4	U1041	48186
1.6		831A4.000	05/83→04/86			1	4	U1041	48186
Thema									
2.0, ie		834B2.000	06/89→08/92		For Vehicles Without Distributor	1	3	U2006	48025
2.0, ie		834B2.000	06/89→08/92		For Vehicles Without Distributor	2	2	U3001	48013
2.0, ie Turbo		834C.000	10/85→12/87			1	4	U1030	48137
2.0, ie Turbo		834C1.000	06/89→06/90		For Vehicles Without Distributor	1	3	U2006	48025
2.0, ie Turbo		834C1.000	06/89→06/90		For Vehicles Without Distributor	2	2	U3001	48013
2.0, ie Turbo		834F2.000	10/92→07/94		For Vehicles Without Distributor	1	3	U2006	48025
2.0, ie Turbo		834F2.000	10/92→07/94		For Vehicles Without Distributor	2	2	U3001	48013
Y10									
1.0		156A2.000, 156A2.246	06/85→12/91		For Vehicles With Distributor	1	4	U1008	48064
1.0, Turbo		156A1.000	06/85→12/88			1	4	U1041	48186
1.1		156C.000	08/89→12/91		For Vehicles With Distributor	1	4	U1008	48064
1.3		156B.000	07/89→12/91		For Vehicles With Distributor	1	4	U1025	48121

LAND ROVER									
Defender 90 (90→)									
2.5, 2 1/2		17H	09/90→07/94		For Vehicles With Distributor	1	2	U1056	48236
3.5		21G	09/90→07/94		For Vehicles With Distributor	1	2	U1076	48339
3.9, 50th Anniversary			11/98→12/99	With Bracket	For Vehicles Without Distributor	1	6	U2045	48196
Defender 110 (90→)									
2.5, 2 1/2		17H	09/90→01/92		For Vehicles With Distributor	1	2	U1056	48236
3.5		21G	09/90→07/94		For Vehicles With Distributor	1	2	U1076	48339
Defender 130 (90→)									
3.5			09/90→07/94		For Vehicles With Distributor	1	2	U1076	48339

LITRE / MODEL	BODY	ENGINE TYPE	DATE	ADDITIONAL INFORMATION	FITMENT INFORMATION	NO. OF COILS	NO. OF PINS	PART NO.	STOCK NO.
LAND ROVER (continued)									
Discovery MK 1 (89→98)									
2.0			09/93→12/97		For Vehicles With Distributor	1	2	U1076	48339
3.5, Carburettor			11/89→09/90		For Vehicles With Distributor	1	2	U1076	48339
3.5, Injection			09/90→12/93		For Vehicles With Distributor	1	2	U1076	48339
3.9		35D, 36D	09/93→10/98		For Vehicles With Distributor	1	2	U1076	48339
3.9		35D, 36D	09/93→10/98	With Bracket	For Vehicles Without Distributor	1	6	U2045	48196
4.0			07/97→12/98		For Vehicles With Distributor	1	2	U1076	48339
Discovery MK 2 (98→04)									
4.0		56D	11/98→06/04		For Vehicles Without Distributor	2	3	U2006	48025
Discovery MK 3 (04→10)									
4.4		448PN	11/04→04/08			8	4	U5082	48267
Freelander MK 1 (97→07)									
1.8		18K4F	02/98→10/06	To Ch. No.: YA999999	For Vehicles With Distributor	1	2	U1027	48125
1.8		18K4F	02/98→10/06	From Ch. No.: 1A000001	For Vehicles Without Distributor, Black Boot, VVT Eng	2	2	U4001	48055
2.5		25K4F	11/00→10/06	To Ch. No.: 3A224999		3	3	U5005	48009
2.5		25K4F	11/00→10/06	From Ch. No.: 3A225000		6	3	U5026	48091
Freelander Mk 2 (07→)									
3.2		B6324, I6	12/06→12/09			6	4	U5149	48399
Land Rover 88 Series 2A									
2.6			01/66→12/68		For Vehicles With Distributor	1	2	U1061	48298
2.6			01/68→12/71		For Vehicles With Distributor	1	2	U1079	48342
Land Rover 88 Series 3									
2.3, 2 1/4		11H	01/72→12/83		For Vehicles With Distributor	1	2	U1079	48342
2.3, 2 1/4		11H	09/71→12/71		For Vehicles With Distributor	1	2	U1056	48236
2.6			01/72→12/85		For Vehicles With Distributor	1	2	U1079	48342
2.6			09/71→12/85		For Vehicles With Distributor	1	2	U1056	48236
Land Rover 90 (83→90)									
2.5, 2 1/2		17H	09/85→07/90		For Vehicles With Distributor	1	2	U1056	48236
Land Rover 109 Series 2A									
2.6			01/66→12/68		For Vehicles With Distributor	1	2	U1061	48298
2.6			01/68→12/71		For Vehicles With Distributor	1	2	U1079	48342
Land Rover 109 Series 3									
2.3, 2 1/4		11H	01/72→07/83		For Vehicles With Distributor	1	2	U1079	48342
2.3, 2 1/4		11H	09/71→12/71		For Vehicles With Distributor	1	2	U1056	48236
2.6			01/72→12/85		For Vehicles With Distributor	1	2	U1079	48342
2.6			09/71→12/85		For Vehicles With Distributor	1	2	U1056	48236
Land Rover 110 (83→90)									
2.5, 2 1/2		17H	09/85→07/90		For Vehicles With Distributor	1	2	U1056	48236
Range Rover MK 1 (70→95)									
3.5, Carburettor		11D	08/81→12/86		For Vehicles With Distributor	1	2	U1076	48339
3.5, Injection		24D, 25D	10/85→10/89		For Vehicles With Distributor	1	2	U1076	48339
3.9, Catalyst			10/92→12/95		For Vehicles With Distributor	1	2	U1076	48339
3.9, Injection		35D, 36D	10/89→10/92		For Vehicles With Distributor	1	2	U1076	48339
4.2		40D	10/92→07/94		For Vehicles With Distributor	1	2	U1076	48339
Range Rover MK 2 P38A (94→02)									
4.0			09/94→03/02	From Ch. No.: XA410482	For Vehicles Without Distributor	2	3	U2006	48025
4.0			09/94→03/02	With Bracket, To Ch. No.: XA410481	For Vehicles Without Distributor	1	6	U2045	48196
4.6		46D	09/94→11/98	From Ch. No.: XA410482	For Vehicles Without Distributor	2	3	U2006	48025
4.6		46D	09/94→11/98	With Bracket, To Ch. No.: XA410481	For Vehicles Without Distributor	1	6	U2045	48196
4.6		60D	11/98→03/02	From Ch. No.: XA410482	For Vehicles Without Distributor	2	3	U2006	48025
4.6		60D	11/98→03/02	With Bracket, To Ch. No.: XA410481	For Vehicles Without Distributor	1	6	U2045	48196
Range Rover MK 3 L322 (02→)									
4.2, Supercharged		428PS	05/05→12/09			8	4	U5082	48267
4.4		AJ-V8	05/05→04/08	From Ch. No.: 6A000001		8	4	U5082	48267

LITRE / MODEL	BODY	ENGINE TYPE	DATE	ADDITIONAL INFORMATION	FITMENT INFORMATION	NO. OF COILS	NO. OF PINS	PART NO.	STOCK NO.
LAND ROVER (continued)									
Range Rover MK 3 L322 (02→)									
4.4		M62	03/02→07/05	To Ch. No.: 5A999999		8	3	U5005	48009
Range Rover Sport (05→)									
4.2, Supercharged		428PS	05/05→12/09			8	4	U5082	48267
4.4		448PN	05/05→04/08			8	4	U5082	48267

LDV									
200									
2.0			04/89→03/96		For Vehicles With Distributor	1	2	U1076	48339
Sherpa 200									
1.7	Pck, Van		01/85→10/86		Electronic Ignition (EI), With Distributor	1	2	U1076	48339
2.0	Van		04/85→03/89		Electronic Ignition (EI), With Distributor	1	2	U1076	48339
Sherpa 300									
1.7	Pck, Van		01/85→10/86		Electronic Ignition (EI), With Distributor	1	2	U1076	48339
2.0	Van		04/85→03/89		Electronic Ignition (EI), With Distributor	1	2	U1076	48339

LEXUS									
GS300 (93→97)									
3.0		2JZ-GE	10/93→08/97		For Vehicles With Distributor	1	2	U1018	48105
GS300 (05→10)									
3.0		3GR-FSE	04/05→04/10			6	4	U5084	48269
GS430 (00→05)									
4.3		3UZ-FE	11/00→07/03			8	4	U5065	48235
GS450 (06→12)									
3.5, h			05/06→11/11			6	4	U5084	48269
IS200 (99→06)									
2.0	Sal	1G-FE	04/99→07/05			6	4	U5065	48235
2.0, Sportcross	Est	1G-FE	10/02→10/05			6	4	U5065	48235
IS250 (05→)									
2.5		4GR-FSE	11/05→			6	4	U5084	48269
LS400 (90→00)									
4.0		1UZ-FE	06/90→12/00		For Vehicles With Distributor	1	2	U1018	48105
LS430 (00→03)									
4.3		3UZ-FE	08/02→07/03			8	4	U5065	48235
LS460 (07→)									
4.6		1UR-FSE	10/06→04/10			8	4	U5084	48269
LS600 (07→)									
5.0, h		2UR-FSE	09/07→			8	4	U5084	48269
RX300									
3.0		1MZ-FE	10/00→12/05			6	4	U5100	48297
RX350 (06→09)									
3.5		2GR-FE	04/06→12/08			6	4	U5076	48257
SC430 (01→10)									
4.3		3UZ-FE	05/01→07/05			8	4	U5065	48235

LOTUS									
Eclat Series 2 - Type 76									
2.2		912	05/80→08/82		For Vehicles With Distributor	1	2	U1056	48236
Elan Type M100									
1.6		4XE1	01/90→12/92			2	2	U3015	48218
1.6, S2		Isuzu-Lotus1.6i16VTurbo	06/94→07/95			2	2	U3015	48218
1.6, SE (Turbo)		4XE1-T	01/90→12/92			2	2	U3015	48218
Elise Series 1 - Type 111									
1.8, 111S (VVC)		18K4K	03/99→11/00		Red Boot, Non VVT Eng	2	2	U4002	48100

LITRE / MODEL	BODY	ENGINE TYPE	DATE	ADDITIONAL INFORMATION	FITMENT INFORMATION	NO. OF COILS	NO. OF PINS	PART NO.	STOCK NO.
LOTUS (continued)									
Esprit									
2.2, S3		912	04/81→08/86		For Vehicles With Distributor	1	2	U1056	48236
2.2, S4		910S	02/93→07/96		For Vehicles With Distributor	1	2	U1056	48236
2.2, S4s			11/94→07/96		For Vehicles With Distributor	1	2	U1056	48236
2.2, Sport 300			05/93→10/94		For Vehicles With Distributor	1	2	U1056	48236
2.2, Turbo SE		910S	05/89→12/93		For Vehicles With Distributor	1	2	U1056	48236
Esprit (80→81)									
2.2		912	05/80→05/81		For Vehicles With Distributor	1	2	U1056	48236
Esprit (80→86)									
2.2, Turbo		910	09/80→10/86		For Vehicles With Distributor	1	2	U1056	48236
Esprit (86→87)									
2.2, Turbo HC		910	10/86→10/87		For Vehicles With Distributor	1	2	U1056	48236
Esprit (87→90)									
2.2, Turbo		910	10/87→08/88		For Vehicles With Distributor	1	2	U1056	48236
Esprit (90→91)									
2.2, S			09/90→10/91		For Vehicles With Distributor	1	2	U1056	48236

MAZDA									
2 (03→07)									
1.25		FUJA	04/03→12/07			1	3	U2008	48027
1.4		FXJA	02/05→12/07			1	3	U2008	48027
1.4		FXJA	04/03→02/05			1	3	U2001	48001
1.6		FYJA	02/05→12/07			1	3	U2008	48027
1.6		FYJA	04/03→02/05			1	3	U2001	48001
3 (04→09)									
2.0	Hbk	LF17	01/04→06/09			4	3	U5063	48229
2.0	Hbk, Sal	LF17	01/04→03/06			4	2	U5019	48063
2.0	Sal	LF17	01/04→03/06			4	2	U5019	48063
2.3, MPS	Hbk	L3N9, L3-VDT	12/06→06/09			4	3	U5063	48229
3 (09→)									
2.0	Hbk	LF17, LF-DE	06/09→05/13			4	3	U5063	48229
2.0	Sal	LF5H, LF5W	06/09→03/11			4	3	U5063	48229
6 (02→08)									
1.8	Hbk	L813	03/02→06/08			1	3	U2074	48369
1.8	Sal	L813	03/02→06/08			1	3	U2074	48369
2.0	Est	LF17, LF18	06/02→08/05			1	3	U2074	48369
2.0	Hbk	LF17, LF18	03/02→08/05			1	3	U2074	48369
2.0	Sal	LF17, LF18	03/02→08/05			1	3	U2074	48369
2.3	Est		06/04→08/05			1	3	U2074	48369
2.3	Est		11/02→08/05			1	3	U2074	48369
2.3	Hbk	L3C1	03/02→06/08			1	3	U2074	48369
2.3	Sal	L3C1	11/03→08/05			1	3	U2074	48369
6 (07→13)									
2.0	Est	LF17	03/08→12/10			4	3	U5063	48229
2.0	Hbk, Sal	LF17	12/07→12/10			4	3	U5063	48229
2.0, DISI	Est, Hbk	LF-DE	04/10→04/13			4	3	U5063	48229
2.5	Est	L5-VE	03/08→04/13			4	3	U5063	48229
2.5	Hbk	L5-VE	12/07→04/13			4	3	U5063	48229
2.5	Sal	L5-VE	12/07→12/10			4	3	U5063	48229
121 (88→91)									
1.1		B1, B116	02/88→10/90			1	4	U1033	48148
121 (91→95)									
1.3, Injection		B3(16V)	02/91→12/95			1	4	U1033	48148
121 (96→99)									
1.3		J4R, J4T	03/96→12/00			1	3	U2001	48001
1.25		DHF, DHG	03/96→04/98		For Vehicles Without Distributor	1	3	U2005	48021

LITRE / MODEL	BODY	ENGINE TYPE	DATE	ADDITIONAL INFORMATION	FITMENT INFORMATION	NO. OF COILS	NO. OF PINS	PART NO.	STOCK NO.
MAZDA (continued)									
121 (96→99)									
1.25		DHF, DHG	04/98→12/99			1	3	U2001	48001
323 (81→85)									
1.5, GT	Hbk	E5	03/81→12/83		For Vehicles With Distributor	1	2	U1068	48305
1.5, GT	Sal	E5	03/82→12/84		For Vehicles With Distributor	1	2	U1068	48305
323 (85→89)									
1.3		B3E	09/89→04/90			1	2	U1036	48158
1.6, Injection		B6(SOHC)	11/85→12/89		For Vehicles With Distributor	1	3	U1021	48112
1.6, Turbo		B6T	10/86→09/87		For Vehicles With Distributor	1	3	U1021	48112
1.6, Turbo Intercooled			09/88→10/89		For Vehicles With Distributor	1	3	U1021	48112
323 (89→94)									
1.3	Hbk	B3(16V)	10/89→07/94			1	4	U1033	48148
1.3	Hbk	B3(16V)	10/89→07/95			1	2	U1036	48158
1.3	Sal	B3(16V)	06/91→12/92			1	4	U1033	48148
1.3	Sal	B3(16V)	06/91→12/92			1	2	U1036	48158
1.6	Est, Hbk	B6	06/91→08/94		For Vehicles With Distributor	1	3	U1021	48112
1.6	Sal	B6	10/89→08/94			1	2	U1036	48158
1.8, GTi	Hbk	BP(DOHC)	06/91→03/93			1	2	U1036	48158
1.8, GTi	Hbk	BP22, BP31	10/89→06/91			1	2	U1036	48158
323 (94→98)									
1.3, F		B3(16V)	04/95→12/95			1	2	U1036	48158
323 (98→03)									
1.5			10/98→12/01		For Vehicles Without Distributor	2	3	U4015	48242
1.6		ZM	06/01→11/03		For Vehicles Without Distributor	2	3	U4015	48242
1.8		FP18, FP55	10/98→01/01			2	3	U4011	48208
2.0		FS7E, FS7G	08/01→11/03			2	3	U4011	48208
626 (83→87)									
1.6	Hbk	F6	05/83→09/87		For Vehicles With Distributor	1	2	U1068	48305
1.6	Sal	F6	05/83→06/87		For Vehicles With Distributor	1	2	U1068	48305
2.0	Cpe, Hbk, Sal	FE	05/83→11/85		For Vehicles With Distributor	1	2	U1068	48305
2.0, Injection	Cpe, Hbk, Sal	FE	01/86→09/87		For Vehicles With Distributor	1	2	U1068	48305
626 (87→92)									
1.8	Hbk		01/90→05/92		For Vehicles With Distributor	1	2	U1068	48305
1.8	Sal	F8(12V)	01/90→05/92		For Vehicles With Distributor	1	2	U1068	48305
2.0	Cpe	FEKat.(16V)	10/87→09/89		For Vehicles With Distributor	1	3	U1021	48112
2.0	Est	FE	06/88→01/90		For Vehicles With Distributor	1	3	U1021	48112
2.0	Est	FEKat.(16V)	10/88→08/89		For Vehicles With Distributor	1	3	U1021	48112
2.0	Est	FEKat.(16V)	10/88→08/89		For Vehicles With Distributor	1	2	U1068	48305
2.0	Est, Hbk, Sal	FE(12V)	01/90→05/92		For Vehicles With Distributor	1	3	U1021	48112
2.0	Est, Hbk, Sal	FE(12V)	01/90→05/92		For Vehicles With Distributor	1	2	U1068	48305
2.0	Hbk	FEKat.(16V)	10/87→08/89		For Vehicles With Distributor	1	3	U1021	48112
2.0	Hbk	FEKat.(16V)	10/87→08/89		For Vehicles With Distributor	1	2	U1068	48305
2.0	Hbk, Sal	FE	10/87→01/90		For Vehicles With Distributor	1	3	U1021	48112
2.0, 4WS	Hbk	FEKat.(16V)	04/88→08/89		For Vehicles With Distributor	1	3	U1021	48112
2.0, 4WS	Hbk	FEKat.(16V)	04/88→08/89		For Vehicles With Distributor	1	2	U1068	48305
2.2	Est	F2, F2L1	05/91→11/92		For Vehicles With Distributor	1	3	U1021	48112
2.2	Hbk	F2	01/90→07/90		For Vehicles With Distributor	1	3	U1021	48112
626 (97→99)									
1.8	Hbk		06/97→10/99		For Vehicles Without Distributor	1	3	U2005	48021
2.0	Est	FS	03/98→12/99		For Vehicles Without Distributor	1	3	U2005	48021
2.0	Est	FS2C	03/98→10/99		For Vehicles Without Distributor	1	3	U2005	48021
2.0	Hbk	FS2C	02/98→10/99		For Vehicles Without Distributor	1	3	U2005	48021
2.0	Hbk, Sal	FS	06/97→12/99		For Vehicles Without Distributor	1	3	U2005	48021

LITRE / MODEL	BODY	ENGINE TYPE	DATE	ADDITIONAL INFORMATION	FITMENT INFORMATION	NO. OF COILS	NO. OF PINS	PART NO.	STOCK NO.
MAZDA (continued)									
626 (99→02)									
1.8	Hbk	FP	12/99→10/02		For Vehicles Without Distributor	1	3	U2005	48021
2.0	Hbk, Sal	FS2C	10/99→10/02		For Vehicles Without Distributor	1	3	U2005	48021
929									
2.0		HEE, MA	01/83→12/87		For Vehicles With Distributor	1	2	U1068	48305
CX7 ER (07→13)									
2.3		L3-VDT	10/07→04/10			4	3	U5063	48229
MPV									
2.3		L3	06/02→01/05			1	3	U2074	48369
MX3 (91→98)									
1.6		B6	09/91→04/94			1	2	U1036	48158
1.6		B6D	04/94→12/98			1	2	U1036	48158
MX5 NA (90→98)									
1.6		B64F	05/90→01/94	With Bracket		1	3	U2053	48250
1.6			04/95→04/98	With Bracket		1	3	U2053	48250
1.6, Turbo			11/90→12/92	With Bracket		1	3	U2053	48250
1.8		BP(DOHC), BPF1	04/95→04/98	With Bracket		1	3	U2037	48167
1.8		BP(DOHC), BPF1	05/94→04/95	With Bracket		1	4	U2050	48224
MX5 NB (98→05)									
1.8		BPD	06/01→10/05			2	3	U4013	48223
1.8		BP-ZE	08/00→06/01	With Bracket		1	3	U2037	48167
MX5 NC (05→)									
2.0		LF62, LF-DE	11/05→			4	3	U5063	48229
Premacy (99→05)									
1.8		FP	07/99→03/05			2	3	U4011	48208
2.0		FS7E, FS7G	11/01→03/05			2	3	U4011	48208
RX8 SE17 (03→10)									
1.3, Renesis (2.6, 2616cc)		13B-MSP	10/03→12/10			4	3	U5093	48283
Tribute (01→05)									
2.0		YF	08/01→03/05			1	3	U2001	48001
3.0		AJ	08/01→03/05			6	2	U5089	48276

MERCEDES BENZ									
190 W201									
2.0		M102.921	09/83→10/84		For Vehicles With Distributor	1	2	U1076	48339
2.0		M102.924	01/85→05/90		For Vehicles With Distributor	1	2	U1076	48339
2.0, E		M102.961	09/83→06/93		Without CAT, With Distributor	1	2	U1076	48339
2.0, E		M102.961, M102.962	09/83→06/93		With CAT, With Distributor	1	2	U1023	48115
2.3		M102.983	07/85→01/87		For Vehicles With Distributor	1	2	U1023	48115
2.5		M102.990, M102.991	09/88→07/93		For Vehicles With Distributor	1	2	U1023	48115
200 S123									
2.0, T		M102.920	04/81→11/85		For Vehicles With Distributor	1	2	U1076	48339
200 S124									
2.0, TE		M102.963	09/88→08/92		For Vehicles With Distributor	1	2	U1023	48115
2.0, TE		M102.963	09/88→08/92		For Vehicles With Distributor	1	2	U1076	48339
2.0, TE		M111.940	10/92→06/93		For Vehicles With Distributor	1	2	U1023	48115
2.0, TE		M111.940	10/92→06/93			2	2	U3006	48050
200 W123									
2.0		M102.920	10/80→09/85		For Vehicles With Distributor	1	2	U1076	48339
200 W124									
2.0		M102.922	12/85→09/88		For Vehicles With Distributor	1	2	U1023	48115
2.0		M102.922	12/85→09/88		For Vehicles With Distributor	1	2	U1076	48339
2.0, E		M102.963	09/88→08/92		For Vehicles With Distributor	1	2	U1076	48339
2.0, E		M102.963	09/90→08/92	From Ch. No.: 146706	For Vehicles With Distributor	1	2	U1023	48115
2.0, E		M111.940	10/92→06/93		For Vehicles With Distributor	1	2	U1023	48115

LITRE / MODEL	BODY	ENGINE TYPE	DATE	ADDITIONAL INFORMATION	FITMENT INFORMATION	NO. OF COILS	NO. OF PINS	PART NO.	STOCK NO.
MERCEDES BENZ (continued)									
200 W124									
2.0, E		M111.940	10/92→06/93			2	2	U3006	48050
220 C124									
2.2, CE		M111.960	10/92→05/93			2	2	U3006	48050
220 S124									
2.2, TE		M111.960	10/92→05/93			2	2	U3006	48050
220 W124									
2.2, E		M111.960	10/92→06/93			2	2	U3006	48050
230 C123									
2.3, CE		M102.980	10/80→09/85		For Vehicles With Distributor	1	2	U1076	48339
230 C124									
2.3, CE		M102.982	10/87→12/92		For Vehicles With Distributor	1	2	U1023	48115
2.3, CE		M102.982	10/87→12/92		For Vehicles With Distributor	1	2	U1076	48339
230 S123									
2.3, TE		M102.980	10/80→11/85		For Vehicles With Distributor	1	2	U1076	48339
230 S124									
2.3, TE		M102.982	05/86→08/92		For Vehicles With Distributor	1	2	U1023	48115
2.3, TE		M102.982	05/86→08/92		For Vehicles With Distributor	1	2	U1076	48339
230 W123									
2.3		M115.954	01/80→12/80		For Vehicles With Distributor	1	2	U1056	48236
2.3, E		M102.980	10/80→09/85		For Vehicles With Distributor	1	2	U1076	48339
230 W124									
2.3, E		M102.982	09/90→10/92	From Ch. No.: 146706	For Vehicles With Distributor	1	2	U1023	48115
2.3, E		M102.982	10/85→12/92	To Ch. No.: 146706	For Vehicles With Distributor	1	2	U1076	48339
250 W123									
2.5		M123.921	01/80→07/85		For Vehicles With Distributor	1	2	U1076	48339
260 W124									
2.6, E		M103.940	10/85→12/89	From Ch. No.: 146706	For Vehicles With Distributor	1	2	U1023	48115
280 C123									
2.7, CE		M110.988	10/80→09/85		For Vehicles With Distributor	1	2	U1076	48339
280 R107									
2.7, SL		M110.982, M110.986, M110.990	10/74→07/85		For Vehicles With Distributor	1	2	U1076	48339
280 S123									
2.7, TE		M110.988	01/80→11/85		For Vehicles With Distributor	1	2	U1076	48339
280 S124									
2.8, TE		M104.942	10/92→06/93			3	1	U4026	48018
280 V124									
2.8, E Limousine		M104.942	10/92→06/93			3	1	U4026	48018
280 W123									
2.7, E		M110.984, M110.988	01/80→09/85		For Vehicles With Distributor	1	2	U1076	48339
280 W124									
2.8, E		M104.942	10/92→06/93			3	1	U4026	48018
280 W126									
2.7, SE		M110.984, M110.988	10/80→09/85		For Vehicles With Distributor	1	2	U1076	48339
300 C124									
3.0, CE		M103.983	10/87→12/89		For Vehicles With Distributor	1	2	U1023	48115
300 R107									
3.0, SL		M103.982	02/86→08/89		For Vehicles With Distributor	1	2	U1074	48311
3.0, SL		M103.982	02/86→08/89		For Vehicles With Distributor	1	2	U1023	48115
3.0, SL		M103.982	02/86→08/89		For Vehicles With Distributor	1	2	U1056	48236
300 R129									
3.0, SL		M103.984	10/89→08/93		For Vehicles With Distributor	1	2	U1023	48115
300 S124									
3.0, TE		M103.983	05/86→12/89		For Vehicles With Distributor	1	2	U1023	48115
3.0, TE 4-Matic		M103.983	04/88→12/89		For Vehicles With Distributor	1	2	U1023	48115

LITRE / MODEL	BODY	ENGINE TYPE	DATE	ADDITIONAL INFORMATION	FITMENT INFORMATION	NO. OF COILS	NO. OF PINS	PART NO.	STOCK NO.
MERCEDES BENZ (continued)									
300 V126									
3.0, SEL		M103.981	04/88→12/89	From Ch. No.: 146706	For Vehicles With Distributor	1	2	U1023	48115
300 W124									
3.0, E		M103.983	10/85→08/92		For Vehicles With Distributor	1	2	U1023	48115
3.0, E 4-Matic		M103.983	04/88→02/92		For Vehicles With Distributor	1	2	U1023	48115
300 W126									
3.0, SE		M103.981	02/86→12/89	From Ch. No.: 146706	For Vehicles With Distributor	1	2	U1023	48115
320 C124									
3.2, CE		M104.992	10/92→05/93			3	1	U4026	48018
320 S124									
3.2, TE		M104.992	10/92→06/93			3	1	U4026	48018
320 W124									
3.2, E		M104.992	10/92→06/93			3	1	U4026	48018
380 C126									
3.8, SEC		M116.963	10/81→07/85	From Ch. No.: 146706	For Vehicles With Distributor	1	2	U1023	48115
380 V126									
3.8, SEL		M116.963	10/80→08/85	From Ch. No.: 146706	For Vehicles With Distributor	1	2	U1023	48115
380 W126									
3.8, SE		M116.963	10/80→08/85	From Ch. No.: 146706	For Vehicles With Distributor	1	2	U1023	48115
400 V140									
4.2, SEL		M119.971	09/91→08/93			8	3	U5114	48334
400 W140									
4.2, SE		M119.971	09/91→08/93			8	3	U5114	48334
420 C126									
4.2, SEC		M116.965	02/86→06/91	From Ch. No.: 146706	For Vehicles With Distributor	1	2	U1023	48115
420 V126									
4.2, SEL		M116.965	02/86→06/91	From Ch. No.: 146706	For Vehicles With Distributor	1	2	U1023	48115
420 W126									
4.2, SE		M116.965	02/86→06/91	From Ch. No.: 146706	For Vehicles With Distributor	1	2	U1023	48115
500 C126									
5.0, SEC		M117.963	10/81→08/85	From Ch. No.: 146706	For Vehicles With Distributor	1	2	U1023	48115
5.0, SEC		M117.965	02/86→09/87		For Vehicles With Distributor	1	2	U1023	48115
500 V126									
5.0, SEL		M117.965	09/87→12/91		For Vehicles With Distributor	1	2	U1023	48115
500 V140									
5.0, SEL		M119.970	05/93→08/93			8	3	U5114	48334
5.0, SEL		M119.970	09/91→05/93		For Vehicles With Distributor	1	2	U1023	48115
500 W124									
5.0, E		M119.974	03/91→06/93		For Cyl.: 1-4, With Distributor	1	2	U1023	48115
500 W126									
5.0, SE		M117.963	10/81→08/85	From Ch. No.: 146706	For Vehicles With Distributor	1	2	U1023	48115
500 W140									
5.0, SE		M119.970	05/93→08/93			8	3	U5114	48334
5.0, SE		M119.970	09/91→05/93		For Vehicles With Distributor	1	2	U1023	48115
560 C126									
5.5, SEC		M117.968	08/86→12/89		For Vehicles With Distributor	1	2	U1023	48115
560 V126									
5.5, SEL		M117.968	08/86→06/91		For Vehicles With Distributor	1	2	U1023	48115
600 C140									
6.0, SEC		M120.980, M120.982	06/93→08/93			8	3	U5114	48334
A Class A140 S168									
1.4, LWB		M166.940	04/01→08/04			1	3	U6006	48017
A Class A140 W168									
1.4		M166.940	09/98→08/04			1	3	U6006	48017

LITRE / MODEL	BODY	ENGINE TYPE	DATE	ADDITIONAL INFORMATION	FITMENT INFORMATION	NO. OF COILS	NO. OF PINS	PART NO.	STOCK NO.
MERCEDES BENZ (continued)									
A Class A150 C169									
1.5		M266.920	02/05→12/09			4	3	U3004	48024
A Class A150 W169									
1.5		M266.920	02/05→12/09			4	3	U3004	48024
A Class A160 C169									
1.5		M266.920	06/09→06/12			4	3	U3004	48024
A Class A160 S168									
1.6, LWB		M166.960	04/01→08/04			1	3	U6006	48017
A Class A160 W168									
1.6		M166.960	09/98→08/04			1	3	U6006	48017
A Class A160 W169									
1.5		M266.920	06/09→06/12			4	3	U3004	48024
A Class A170 C169									
1.7		M266.940	02/05→12/09			4	3	U3004	48024
A Class A170 W169									
1.7		M266.940	02/05→12/09			4	3	U3004	48024
A Class A180 C169									
1.7		M266.940	06/09→06/12			4	3	U3004	48024
A Class A180 W169									
1.7		M266.940	06/09→06/12			4	3	U3004	48024
A Class A190 S168									
1.9, LWB		M166.990	04/01→04/04			1	3	U6006	48017
A Class A190 W168									
1.9		M166.990	06/99→04/04			1	3	U6006	48017
A Class A200 C169									
2.0		M266.960	02/05→09/08			4	3	U3004	48024
2.0, Turbo		M266.980	10/05→09/08			4	3	U3004	48024
A Class A200 W169									
2.0			02/05→09/08			1	3	U3004	48024
2.0, Turbo			10/05→09/08			1	3	U3004	48024
A Class A210 S168									
2.1, Evolution LWB		M166.995	04/02→04/04			1	3	U6006	48017
A Class A210 W168									
2.1, Evolution		M166.995	04/02→04/04			1	3	U6006	48017
B Class B150 W245									
1.5		M266.920	10/05→06/10			4	3	U3004	48024
B Class B160 W245									
1.5		M266.920	12/09→11/11			4	3	U3004	48024
B Class B170 W245									
1.7		M266.940	10/05→06/10			4	3	U3004	48024
B Class B180 W245									
1.7		M266.940	12/09→11/11			4	3	U3004	48024
B Class B200 W245									
2.0			10/05→09/08			1	3	U3004	48024
2.0, Turbo			10/05→09/08			1	3	U3004	48024
C Class C32 S203									
3.2, AMG		M112.961	08/01→06/04			6	3	U3004	48024
C Class C32 W203									
3.2, AMG		M112.961	08/01→06/04			6	3	U3004	48024
C Class C36 W202									
3.6, AMG		M104.941(AMG3.6)	07/94→10/97			3	1	U4026	48018
C Class C43 S202									
4.3, AMG		M113.944	02/98→10/00			8	3	U3004	48024
C Class C43 W202									
4.3, AMG		M113.944	02/98→05/00			8	3	U3004	48024

LITRE / MODEL	BODY	ENGINE TYPE	DATE	ADDITIONAL INFORMATION	FITMENT INFORMATION	NO. OF COILS	NO. OF PINS	PART NO.	STOCK NO.
MERCEDES BENZ (continued)									
C Class C55 S203									
5.4, AMG		M113.988	06/04→08/07			8	3	U3004	48024
C Class C55 W203									
5.4, AMG		M113.988	06/04→02/07			8	3	U3004	48024
C Class C63 S204									
6.2, AMG		M156.985	05/08→			8	4	U5117	48337
C Class C160 CL203									
1.8		M271.921	08/05→11/06	To Eng. No.: 30853899		4	3	U5034	48131
1.8		M271.921	11/06→09/07			4	3	U5056	48207
C Class C180 C204									
1.8, BlueEFFICIENCY		M271.820	06/11→03/13			4	3	U5056	48207
C Class C180 CL203									
1.8, Kompressor		M271.946	07/02→11/06	To Eng. No.: 30853899		4	3	U5034	48131
1.8, Kompressor		M271.946	11/06→09/08	From Eng. No.: 30853900		4	3	U5056	48207
2.0		M111.951	05/01→05/02			4	3	U5025	48089
C Class C180 S202									
1.8		M111.920, M111.921	06/96→09/00			2	2	U3006	48050
1.8		M111.920, M111.921	06/96→09/00			2	1	U4026	48018
C Class C180 S203									
1.8, Kompressor		M271.946	07/02→11/06	To Eng. No.: 30853899		4	3	U5034	48131
1.8, Kompressor		M271.946	11/06→08/07	From Eng. No.: 30853900		4	3	U5056	48207
2.0		M111.951	05/01→05/02			4	3	U5025	48089
C Class C180 S204									
1.6, K		M271.910	01/09→12/10			4	3	U5056	48207
1.8		M271.952	05/08→05/09			4	3	U5056	48207
C Class C180 W202									
1.8		M111.920, M111.921	10/93→05/00			2	2	U3006	48050
1.8		M111.920, M111.921	10/93→05/00			2	1	U4026	48018
C Class C180 W203									
1.8, Kompressor		M271.946	07/02→11/06	To Eng. No.: 30853899		4	3	U5034	48131
1.8, Kompressor		M271.946	11/06→02/07	From Eng. No.: 30853900		4	3	U5056	48207
2.0		M111.951	10/00→05/02			4	3	U5025	48089
C Class C180 W204									
1.6, K		M271.910	01/09→12/10			4	3	U5056	48207
1.8		M271.820, M271.952	06/07→05/09			4	3	U5056	48207
1.8, BlueEFFICIENCY		M271.820	02/11→03/13			4	3	U5056	48207
1.8, CGI		M271.820	04/10→08/11			4	3	U5056	48207
C Class C200 CL203									
1.8, Kompressor		M271.940	07/02→11/06			4	3	U5034	48131
1.8, Kompressor		M271.940	11/06→09/08			4	3	U5056	48207
2.0, Kompressor		M111.955	05/01→05/02			4	3	U5025	48089
C Class C200 S202									
2.0		M111.941, M111.945	06/96→06/00			2	2	U3006	48050
2.0		M111.941, M111.945	06/96→06/00			2	1	U4026	48018
2.0, Kompressor		M111.956	09/00→03/01			4	3	U5025	48089
C Class C200 S203									
1.8, Kompressor		M271.940	07/02→11/06			4	3	U5034	48131
1.8, Kompressor		M271.940	11/06→08/07			4	3	U5056	48207
2.0, Kompressor		M111.955	05/01→05/02			4	3	U5025	48089
C Class C200 S204									
1.8		M271.950	05/08→03/10			4	3	U5056	48207
C Class C200 W202									
2.0		M111.941, M111.945	01/94→05/00			2	2	U3006	48050
2.0		M111.941, M111.945	01/94→05/00			2	1	U4026	48018
C Class C200 W203									
1.8, Kompressor		M271.940	06/04→11/06			4	3	U5034	48131

LITRE / MODEL	BODY	ENGINE TYPE	DATE	ADDITIONAL INFORMATION	FITMENT INFORMATION	NO. OF COILS	NO. OF PINS	PART NO.	STOCK NO.
MERCEDES BENZ (continued)									
C Class C200 W203									
1.8, Kompressor		M271.940	11/06→02/07			4	3	U5056	48207
1.8, Kompressor		M271.942	07/03→06/04			4	3	U5034	48131
2.0, Kompressor		M111.955	09/00→05/02			4	3	U5025	48089
C Class C200 W204									
1.8		M271.820, M271.950	06/07→03/10			4	3	U5056	48207
C Class C220 W202									
2.2		M111.961	10/93→10/96			2	2	U3006	48050
C Class C230 CL203									
1.8, Kompressor		M271.948	07/02→08/05	To Eng. No.: 30853899		4	3	U5034	48131
2.3, Kompressor		M111.981	05/01→05/02			4	3	U5025	48089
C Class C230 S202									
2.3		M111.974	06/96→06/97			2	1	U4026	48018
2.3, Kompressor		M111.975	06/97→09/00			2	1	U4026	48018
C Class C230 S203									
1.8, Kompressor		M271.948	06/04→08/05	To Eng. No.: 30853899		4	3	U5034	48131
C Class C230 S204									
2.5		M272.921	05/08→03/10			6	4	U5117	48337
C Class C230 W202									
2.3		M111.974	06/96→06/97			2	1	U4026	48018
2.3, Kompressor		M111.975	10/95→05/00			2	1	U4026	48018
C Class C230 W203									
1.8, Kompressor		M271.948	06/04→08/05	To Eng. No.: 30853899		4	3	U5034	48131
C Class C230 W204									
2.5		M272.921	06/07→03/10			6	4	U5117	48337
C Class C240 S202									
2.4		M112.910	06/97→06/00			6	3	U3004	48024
2.6		M112.915	09/00→03/01			6	3	U3004	48024
C Class C240 S203									
2.6		M112.912	05/01→06/04			6	3	U3004	48024
C Class C240 W202									
2.4		M112.910	06/97→06/00			6	3	U3004	48024
2.6		M112.912	06/00→10/00			6	3	U3004	48024
C Class C240 W203									
2.6		M112.912	09/00→06/04			6	3	U3004	48024
C Class C250 C204									
1.8, BlueEFFICIENCY		M271.860	06/11→			4	3	U5056	48207
C Class C250 S204									
1.8, BlueEFFICIENCY		M271.860	02/11→			4	3	U5056	48207
1.8, CGI		M271.860	07/09→08/11			4	3	U5056	48207
C Class C250 W204									
1.8, BlueEFFICIENCY		M271.860	02/11→			4	3	U5056	48207
1.8, CGI		M271.860	07/09→08/11			4	3	U5056	48207
C Class C280 S202									
2.8		M112.920	06/97→08/00			6	3	U3004	48024
C Class C280 S204									
3.0		M272.947	05/08→03/10			6	4	U5117	48337
C Class C280 W202									
2.8		M104.941	03/94→06/97			2	1	U4026	48018
2.8		M112.920	06/97→08/00			6	3	U3004	48024
C Class C280 W204									
3.0		M272.947	06/07→03/10			6	4	U5117	48337
C Class C320 CL203									
3.2		M112.946	01/03→07/05			6	3	U3004	48024
C Class C320 S203									
3.2		M112.946	05/01→07/05			6	3	U3004	48024

LITRE / MODEL	BODY	ENGINE TYPE	DATE	ADDITIONAL INFORMATION	FITMENT INFORMATION	NO. OF COILS	NO. OF PINS	PART NO.	STOCK NO.
MERCEDES BENZ (continued)									
C Class C320 W203									
3.2		M112.946	09/00→07/05			6	3	U3004	48024
C Class C350 CL203									
3.5		M272.960	07/05→09/08			6	3	U3004	48024
C Class C350 S203									
3.5		M272.960	07/05→08/07			6	3	U3004	48024
C Class C350 S204									
3.5		M272.961	05/08→08/11			6	4	U5117	48337
C Class C350 W203									
3.5		M272.960	07/05→02/07			6	3	U3004	48024
C Class C350 W204									
3.5		M272.961	06/07→08/11			6	4	U5117	48337
CLC Class CLC160 CL203									
1.6		M271.911	06/09→08/11			4	3	U5056	48207
CLC Class CLC180 CL203									
1.8, K		M271.946	06/08→08/11			4	3	U5056	48207
CLC Class CLC200 CL203									
1.8, K		M271.955	06/08→08/11			4	3	U5056	48207
CLC Class CLC230 CL203									
2.5		M272.920	06/08→03/10			6	4	U5117	48337
CLC Class CLC350 CL203									
3.5		M272.960	06/08→03/10			6	4	U5117	48337
CL Class CL55 C215									
5.4, AMG		M113.986	06/00→09/02			8	3	U3004	48024
5.4, AMG		M113.991	09/02→06/04			8	3	U3004	48024
CL Class CL420 C140									
4.2		M119.971, M119.981	06/96→02/99			8	3	U5114	48334
CL Class CL500 C140									
5.0		M119.970	06/96→02/99			8	3	U5114	48334
CL Class CL500 C215									
5.0		M113.960	01/00→03/06			8	3	U3004	48024
CL Class CL500 C216									
5.5		M273.961	09/06→04/11			8	4	U5117	48337
CL Class CL600 C140									
6.0		M120.980, M120.982	06/96→02/99			8	3	U5114	48334
CLK Class CLK55 A209									
5.4, AMG		M113.987	06/03→09/06			8	3	U3004	48024
CLK Class CLK55 C208									
5.4, AMG		M113.981, M113.984	08/99→06/02			8	3	U3004	48024
CLK Class CLK55 C209									
5.4, AMG		M113.987	05/03→09/06			8	3	U3004	48024
CLK Class CLK200 A208									
2.0, Kompressor		M111.956	06/00→03/02			4	3	U5025	48089
CLK Class CLK200 A209									
1.8, Kompressor		M271.940	06/03→11/06	To Eng. No.: 30853899		4	3	U5034	48131
1.8, Kompressor		M271.940	11/06→02/07	From Eng. No.: 30853900		4	3	U5056	48207
1.8, Kompressor		M271.955	11/06→03/10			4	3	U5056	48207
CLK Class CLK200 C208									
2.0		M111.941, M111.945	06/97→06/00			2	1	U4026	48018
2.0, Kompressor		M111.956	06/00→06/02			4	3	U5025	48089
CLK Class CLK200 C209									
1.8, Kompressor		M271.940	09/02→11/06	To Eng. No.: 30853899		4	3	U5034	48131
1.8, Kompressor		M271.940	11/06→02/07	From Eng. No.: 30853900		4	3	U5056	48207
1.8, Kompressor		M271.955	11/06→05/09			4	3	U5056	48207

LITRE / MODEL	BODY	ENGINE TYPE	DATE	ADDITIONAL INFORMATION	FITMENT INFORMATION	NO. OF COILS	NO. OF PINS	PART NO.	STOCK NO.
MERCEDES BENZ (continued)									
CLK Class CLK230 A208									
2.3, Kompressor		M111.973, M111.975	06/98→06/00			2	1	U4026	48018
2.3, Kompressor		M111.982	06/00→03/02			4	3	U5025	48089
CLK Class CLK230 C208									
2.3, Kompressor		M111.973, M111.975	06/97→06/00			2	1	U4026	48018
2.3, Kompressor		M111.982	06/00→06/02			4	3	U5025	48089
CLK Class CLK240 A209									
2.6		M112.912	06/03→08/05			6	3	U3004	48024
CLK Class CLK240 C209									
2.6		M112.912	06/02→08/05			6	3	U3004	48024
CLK Class CLK280 A209									
3.0		M272.940	07/05→03/10			6	4	U5117	48337
CLK Class CLK280 C209									
3.0		M272.940	07/05→05/09			6	4	U5117	48337
CLK Class CLK320 A208									
3.2		M112.940	06/98→03/02			6	3	U3004	48024
CLK Class CLK320 A209									
3.2		M112.955	06/03→08/05			6	3	U3004	48024
CLK Class CLK320 C208									
3.2		M112.940	06/97→06/02			6	3	U3004	48024
CLK Class CLK320 C209									
3.2		M112.955	06/02→08/05			6	3	U3004	48024
CLK Class CLK350 A209									
3.5		M272.960	07/05→03/10			6	4	U5117	48337
CLK Class CLK350 C209									
3.5		M272.960	07/05→05/09			6	4	U5117	48337
CLK Class CLK430 A208									
4.3		M113.943	08/99→03/02			8	3	U3004	48024
CLK Class CLK430 C208									
4.3		M113.943	08/99→06/02			8	3	U3004	48024
CLK Class CLK500 A209									
5.0		M113.968	06/03→12/06			8	3	U3004	48024
5.5		M273.967	09/06→03/10			8	4	U5117	48337
CLK Class CLK500 C209									
5.0		M113.968	04/02→12/06			8	3	U3004	48024
5.5		M273.965	09/06→05/09			8	3	U3004	48024
CLS Class CLS55 C219									
5.4, AMG		M113.990	05/05→08/06			8	3	U3004	48024
CLS Class CLS350 C219									
3.5		M272.964	03/05→07/06			6	4	U5117	48337
CLS Class CLS500 C219									
5.0		M113.967	03/05→07/06			8	3	U3004	48024
5.5		M273.960	04/06→12/10			8	4	U5117	48337
E Class E36 A124									
3.6, AMG		M104.992(AMG3.6)	07/94→08/95			3	1	U4026	48018
E Class E36 C124									
3.6, AMG		M104.992(AMG3.6)	07/94→08/95			3	1	U4026	48018
E Class E36 S124									
3.6, AMG		M104.992(AMG3.6)	07/94→08/95			3	1	U4026	48018
E Class E36 W124									
3.6, AMG		M104.992(AMG3.6)	07/94→01/95			3	1	U4026	48018
E Class E55 S210									
5.4, AMG		M113.980	02/98→03/03			8	3	U3004	48024
E Class E55 S211									
5.4, AMG		M113.990	10/03→08/06			8	3	U3004	48024

LITRE / MODEL	BODY	ENGINE TYPE	DATE	ADDITIONAL INFORMATION	FITMENT INFORMATION	NO. OF COILS	NO. OF PINS	PART NO.	STOCK NO.
MERCEDES BENZ (continued)									
E Class E55 W210									
5.4, AMG		M113.980	02/98→03/02			8	3	U3004	48024
E Class E55 W211									
5.4, AMG		M113.990	10/02→08/06			8	3	U3004	48024
E Class E200 A207									
1.8, CGI BlueEFFICIENCY		M271.820, M271.860	02/10→			4	3	U5056	48207
E Class E200 C207									
1.8, CGI BlueEFFICIENCY		M271.820, M271.860	01/10→			4	3	U5056	48207
E Class E200 S124									
2.0		M111.940	08/93→06/96			2	2	U3006	48050
E Class E200 S210									
2.0		M111.942	06/96→06/00			2	1	U4026	48018
2.0, Kompressor		M111.957	08/00→12/02			4	3	U5025	48089
E Class E200 S211									
1.8, K		M271.941	07/03→08/06			4	3	U5034	48131
1.8, Kompressor		M271.956	07/06→11/06			4	3	U5034	48131
1.8, Kompressor		M271.956	11/06→07/09			4	3	U5056	48207
E Class E200 S212									
1.8, CGI BlueEFFICIENCY		M271.820, M271.860	12/09→12/12			4	3	U5056	48207
E Class E200 W124									
2.0		M111.940	08/93→06/95			2	2	U3006	48050
E Class E200 W210									
2.0		M111.942	10/95→06/00			2	1	U4026	48018
2.0, Kompressor		M111.957	08/00→03/02			4	3	U5025	48089
E Class E200 W211									
1.8, Kompressor		M271.941	11/02→08/06			4	3	U5034	48131
1.8, Kompressor		M271.956	07/06→11/06			4	3	U5034	48131
1.8, Kompressor		M271.956	11/06→12/08			4	3	U5056	48207
E Class E200 W212									
1.8, CGI BlueEFFICIENCY		M271.820, M271.860	08/09→			4	3	U5056	48207
E Class E220 A124									
2.2		M111.960	08/93→01/97			2	2	U3006	48050
E Class E220 C124									
2.2		M111.960	08/93→06/96			2	2	U3006	48050
E Class E220 S124									
2.2		M111.960	08/93→06/96			2	2	U3006	48050
E Class E220 W124									
2.2		M111.960	08/93→06/95			2	2	U3006	48050
E Class E230 S210									
2.3		M111.970	06/96→06/97			2	1	U4026	48018
E Class E230 W210									
2.3		M111.970	10/95→06/97			2	1	U4026	48018
E Class E240 S210									
2.4		M112.911	06/99→06/00			6	3	U3004	48024
2.6		M112.914	06/00→05/03			6	3	U3004	48024
E Class E240 S211									
2.6		M112.913	07/03→09/05			6	3	U3004	48024
E Class E240 W210									
2.4		M112.911	06/99→06/00			6	3	U3004	48024
2.6		M112.914	06/00→06/02			6	3	U3004	48024
E Class E240 W211									
2.6		M112.913, M112.917	06/02→09/05			6	3	U3004	48024
E Class E250 A207									
1.8, CGI BlueEFFICIENCY		M271.860	02/10→			4	3	U5056	48207
E Class E250 C207									
1.8, CGI BlueEFFICIENCY		M271.860	06/09→			4	3	U5056	48207

LITRE / MODEL	BODY	ENGINE TYPE	DATE	ADDITIONAL INFORMATION	FITMENT INFORMATION	NO. OF COILS	NO. OF PINS	PART NO.	STOCK NO.
MERCEDES BENZ (continued)									
E Class E250 S212									
1.8, CGI BlueEFFICIENCY		M271.860	12/09→			4	3	U5056	48207
E Class E250 W212									
1.8, CGI BlueEFFICIENCY		M271.860	05/09→			4	3	U5056	48207
E Class E280 S124									
2.8		M104.942	08/93→06/96			3	1	U4026	48018
E Class E280 S210									
2.8		M112.921	01/99→03/03			6	3	U3004	48024
E Class E280 V124									
2.8, Limousine		M104.942	08/93→06/95			2	1	U4026	48018
E Class E280 W124									
2.8		M104.942	08/93→06/95			2	1	U4026	48018
E Class E280 W210									
2.8		M104.945	01/96→03/97			3	1	U4026	48018
2.8		M112.921	03/97→03/02			6	3	U3004	48024
E Class E320 A124									
3.2		M104.992, M104.995	08/93→10/96			3	1	U4026	48018
E Class E320 C124									
3.2		M104.992	08/93→06/96			3	1	U4026	48018
E Class E320 S124									
3.2		M104.992	08/93→06/96			3	1	U4026	48018
E Class E320 S210									
3.2		M112.941	06/97→12/02			6	3	U3004	48024
E Class E320 S211									
3.2		M112.949	07/03→02/05			6	3	U3004	48024
E Class E320 W124									
3.2		M104.992	08/93→06/95			3	1	U4026	48018
E Class E320 W210									
3.2		M104.995	10/95→06/97			3	1	U4026	48018
3.2		M112.941	06/97→03/02			6	3	U3004	48024
E Class E320 W211									
3.2		M112.949	06/02→02/05			6	3	U3004	48024
E Class E350 C207									
3.5, CGI BlueEFFICIENCY		M272.982, M272.984	06/09→			6	3	U3004	48024
E Class E350 S211									
3.5, CGI		M272.985	12/08→07/09			6	3	U3004	48024
E Class E350 S212									
3.5, CGI BlueEFFICIENCY		M272.983	12/09→			6	3	U3004	48024
E Class E430 S210									
4.3		M113.940	09/97→03/03			8	3	U3004	48024
E Class E430 W210									
4.3		M113.940	09/97→03/02			8	3	U3004	48024
E Class E500 A207									
5.5		M273.966	02/10→03/12			8	4	U5117	48337
E Class E500 C207									
5.5		M273.966	06/09→03/12			8	4	U5117	48337
E Class E500 S211									
5.0		M113.967	10/03→08/06			8	3	U3004	48024
5.5		M273.960	07/06→07/09			8	3	U3004	48024
E Class E500 S212									
5.5		M273.971	12/09→12/12			8	4	U5117	48337
E Class E500 W124									
5.0		M119.974	08/93→06/95		For Cyl.: 1-4, With Distributor	1	2	U1023	48115
E Class E500 W211									
5.0		M113.967	06/02→08/06			8	3	U3004	48024

LITRE / MODEL	BODY	ENGINE TYPE	DATE	ADDITIONAL INFORMATION	FITMENT INFORMATION	NO. OF COILS	NO. OF PINS	PART NO.	STOCK NO.
MERCEDES BENZ (continued)									
E Class E500 W211									
5.5		M273.960	07/06→12/08			8	3	U3004	48024
E Class E500 W212									
5.5		M273.971	05/09→03/12			8	4	U5117	48337
G Class 230 W460									
2.3, GE		M102.981, M102.987, M102.989	09/83→12/90		For Vehicles With Distributor	1	2	U1023	48115
2.3, GE		M102.981, M102.987, M102.989	09/83→12/90		For Vehicles With Distributor	1	2	U1076	48339
G Class 280 W460									
2.7, GE		M110.994	08/84→08/89		For Vehicles With Distributor	1	2	U1076	48339
2.7, GEL		M110.994	08/84→08/89		For Vehicles With Distributor	1	2	U1076	48339
G Class 300 W463									
3.0, GEL		M103.987	01/91→08/93		For Vehicles With Distributor	1	2	U1023	48115
3.0, GES		M103.987	01/91→08/93		For Vehicles With Distributor	1	2	U1023	48115
G Class G300 W463									
3.0, LWB		M103.987	08/93→12/97		For Vehicles With Distributor	1	2	U1023	48115
3.0, SWB		M103.987	08/93→12/97		For Vehicles With Distributor	1	2	U1023	48115
M Class ML55 W163									
5.4, AMG		M113.981	09/00→04/04			8	3	U3004	48024
M Class ML320 W163									
3.2		M112.942	04/98→08/02			6	3	U3004	48024
M Class ML350 W163									
3.7		M112.970	09/02→06/05			6	3	U3004	48024
M Class ML430 W163									
4.3		M113.942	10/98→12/01			8	3	U3004	48024
M Class ML500 W163									
5.0		M113.964, M113.965	09/01→06/05			8	3	U3004	48024
M Class ML500 W164									
5.0		M113.964	09/05→08/08			8	3	U3004	48024
R Class R500 W251									
5.0		M113.971	03/06→12/06			8	3	U3004	48024
S Class S55 V220									
5.4, AMG		M113.986	06/00→12/02			8	3	U3004	48024
5.4, AMG		M113.991	09/02→08/05			8	3	U3004	48024
S Class S55 W220									
5.4, AMG		M113.986	06/00→12/02			8	3	U3004	48024
5.4, AMG		M113.991	09/02→08/05			8	3	U3004	48024
S Class S280 W140									
2.8		M104.944	08/93→10/98			3	1	U4026	48018
S Class S280 W220									
2.8		M112.922	12/98→08/05			6	3	U3004	48024
S Class S280 W221									
3.0		M272.946	09/06→09/08			6	4	U5117	48337
S Class S320 V140									
3.2, Limousine		M104.990	08/93→10/98			3	1	U4026	48018
S Class S320 V220									
3.2, Limousine		M112.944	12/98→12/02			6	3	U3004	48024
S Class S320 W140									
3.2		M104.990	08/93→10/98			3	1	U4026	48018
S Class S320 W220									
3.2		M112.944	12/98→12/02			6	3	U3004	48024
S Class S350 V220									
3.7, Limousine		M112.972	09/02→08/05			6	3	U3004	48024
S Class S350 V221									
3.5		M272.965	03/06→06/11			6	4	U5117	48337

LITRE / MODEL	BODY	ENGINE TYPE	DATE	ADDITIONAL INFORMATION	FITMENT INFORMATION	NO. OF COILS	NO. OF PINS	PART NO.	STOCK NO.
MERCEDES BENZ (continued)									
S Class S350 W220									
3.7		M112.972	09/02→08/05			6	3	U3004	48024
S Class S350 W221									
3.5		M272.965	03/06→06/11			6	4	U5117	48337
S Class S420 C140									
4.2		M119.971, M119.981	04/96→12/96		For Vehicles With Distributor	1	2	U1074	48311
4.2		M119.971, M119.981	04/96→12/96			8	3	U5114	48334
S Class S420 V140									
4.2, Limousine		M119.971	08/93→10/98		For Vehicles With Distributor	1	2	U1074	48311
4.2, Limousine		M119.971	08/93→10/98			8	3	U5114	48334
S Class S420 W140									
4.2		M119.971	08/93→10/98		For Vehicles With Distributor	1	2	U1074	48311
4.2		M119.971	08/93→10/98			8	3	U5114	48334
S Class S430 V220									
4.3, Limousine		M113.941	12/98→04/04			8	3	U3004	48024
S Class S430 W220									
4.3		M113.941	12/98→04/04			8	3	U3004	48024
S Class S500 C140									
5.0		M119.970	08/93→01/97		For Vehicles With Distributor	1	2	U1074	48311
5.0		M119.970	08/93→01/97			8	3	U5114	48334
S Class S500 V140									
5.0, Limousine		M119.970, M119.980	08/93→10/98			8	3	U5114	48334
5.0, Limousine		M119.970, M119.980	08/93→10/98		For Vehicles With Distributor	1	2	U1074	48311
S Class S500 V220									
5.0, Limousine		M113.960	09/02→08/05			8	3	U3004	48024
S Class S500 V221									
5.5		M273.961	03/06→06/11			8	4	U5117	48337
S Class S500 W140									
5.0		M119.970, M119.980	08/93→10/98			8	3	U5114	48334
5.0		M119.970, M119.980	08/93→10/98		For Vehicles With Distributor	1	2	U1074	48311
S Class S500 W220									
5.0		M113.960	09/02→08/05			8	3	U3004	48024
S Class S500 W221									
5.5		M273.961	03/06→06/11			8	4	U5117	48337
S Class S600 C140									
6.0		M120.980, M120.982	08/93→01/97		For Vehicles With Distributor	1	2	U1074	48311
6.0		M120.980, M120.982	08/93→01/97			8	3	U5114	48334
SL Class SL55 R230									
5.4, AMG		M113.992	03/02→03/06			8	3	U3004	48024
5.4, AMG		M113.995	03/06→06/08			8	3	U3004	48024
SL Class SL60 R129									
6.0, AMG		M122.981	05/97→08/00			8	3	U5114	48334
SL Class SL280 R129									
2.8		M104.943	08/93→06/98			3	1	U4026	48018
2.8		M112.923, M112.925	06/98→10/01			6	3	U3004	48024
SL Class SL320 R129									
3.2		M104.991	09/93→06/98			3	1	U4026	48018
3.2		M112.943	06/98→10/01			6	3	U3004	48024
SL Class SL350 R230									
3.7		M112.973	03/03→04/06			6	3	U3004	48024
SL Class SL500 R129									
5.0		M113.961	06/00→10/01			8	3	U3004	48024
5.0		M119.982	05/95→05/98		For Vehicles With Distributor	1	2	U1074	48311
5.0		M119.982	05/95→05/98			8	3	U5114	48334
SL Class SL500 R230									
5.0		M113.963	03/02→04/06			8	3	U3004	48024

LITRE / MODEL	BODY	ENGINE TYPE	DATE	ADDITIONAL INFORMATION	FITMENT INFORMATION	NO. OF COILS	NO. OF PINS	PART NO.	STOCK NO.
MERCEDES BENZ (continued)									
SL Class SL600 R129									
6.0		M120.981, M120.983	09/95→04/01		For Vehicles With Distributor	1	2	U1074	48311
6.0		M120.981, M120.983	09/95→04/01			8	3	U5114	48334
SLK Class SLK32 R170									
3.2, AMG		M112.960	08/01→04/04			6	3	U3004	48024
SLK Class SLK55 R171									
5.4, AMG		M113.989	08/04→02/11			8	3	U3004	48024
SLK Class SLK200 R170									
2.0, Kompressor		M111.958	03/00→04/04			4	3	U5025	48089
SLK Class SLK200 R171									
1.8, Kompressor		M271.944	07/04→11/06			4	3	U5034	48131
1.8, Kompressor		M271.944	11/06→06/08			4	3	U5056	48207
1.8, Kompressor		M271.954	04/08→02/11			4	3	U5056	48207
SLK Class SLK230 R170									
2.3, Kompressor		M111.973, M111.983	03/00→04/04			4	3	U5025	48089
2.3, Kompressor		M111.973, M111.983	11/96→03/00			2	1	U4026	48018
SLK Class SLK280 R171									
3.0		M272.942	05/05→03/10			6	4	U5117	48337
SLK Class SLK320 R170									
3.2		M112.947	03/00→04/04			6	3	U3004	48024
SLR Class C199									
5.4, McLaren SLR		M155.980	09/04→12/08			8	3	U3004	48024
5.4, McLaren SLR 722		M155.980	01/07→12/09			8	3	U3004	48024
SLR Class R199									
5.4, McLaren SLR	Cnv	M155.980	09/07→06/09			8	3	U3004	48024
5.4, McLaren SLR Stirling Moss	Rds	M155.980	05/09→06/10			8	3	U3004	48024
Sprinter (95→00)									
2.3, 214		M111.979, M111.984	05/95→02/00			2	1	U4026	48018
Sprinter (00→06)									
2.3, 214		M111.979, M111.984	02/00→05/06			2	1	U4026	48018
2.3, 214 Dual Fuel		M111.979, M111.984	02/03→05/06			2	1	U4026	48018
2.3, 314		M111.979, M111.984	02/00→05/06			2	1	U4026	48018
2.3, 314		M111.984	10/03→05/06			2	1	U4026	48018
2.3, 314 Dual Fuel		M111.979, M111.984	02/03→05/06			2	1	U4026	48018
2.3, 414		M111.979	02/00→05/06			2	1	U4026	48018
Vaneo W414									
1.6		M166.961	05/02→07/05			1	3	U6006	48017
1.9		M166.991	05/02→07/05			1	3	U6006	48017
V Class V230 W638									
2.3		M111.978	11/96→07/03			2	1	U4026	48018
V Class V280 W638									
2.8		M104.900	04/98→07/03	Angular Connector	Incl. Control Unit, For Vehicles Without Distributor	1	5	U2024	48087
Viano W639									
3.2		M112.951	11/03→03/05			6	3	U3004	48024
3.5		M112.976	03/05→12/08			6	3	U3004	48024
Vito W638									
2.0, 113		M111.948, M111.950	03/97→07/03			2	1	U4026	48018

MG									
Maestro (83→94)									
1.6		16H	03/83→09/84		For Vehicles With Distributor	1	2	U1076	48339
2.0			10/84→09/90		For Vehicles With Distributor	1	2	U1076	48339
2.0, Turbo			01/89→09/90		For Vehicles With Distributor	1	2	U1076	48339

LITRE / MODEL	BODY	ENGINE TYPE	DATE	ADDITIONAL INFORMATION	FITMENT INFORMATION	NO. OF COILS	NO. OF PINS	PART NO.	STOCK NO.
MG (continued)									
Metro (80→90)									
1.3, MG/Sport			05/82→06/84		Conventional Coil Ignition (CI), With Distributor	1	2	U1056	48236
1.3, MG/Sport/GTA			07/84→09/90		Electronic Ignition (EI), With Distributor	1	2	U1076	48339
1.3, MG Turbo			10/82→09/89		For Vehicles With Distributor	1	2	U1076	48339
MGB MK 2									
1.8	Cnv		06/75→01/80		For Vehicles With Distributor	1	2	U1056	48236
1.8	Cnv		06/75→01/80		For Vehicles With Distributor	1	2	U1079	48342
1.8, GT	Cpe		06/75→01/80		For Vehicles With Distributor	1	2	U1056	48236
3.5, GTV8	Cpe		03/73→12/76		For Vehicles With Distributor	1	2	U1056	48236
MGC									
2.9	Cnv, Cpe		03/67→09/69		For Vehicles With Distributor	1	2	U1079	48342
MG Express									
1.4		14K4F	03/03→05/05	With Bracket	For Vehicles With Distributor	1	2	U1006	48059
1.4		14K4F	03/03→05/05		For Vehicles Without Distributor, Black Boot, VVT Eng	2	2	U4001	48055
MGF									
1.6		16K4F	02/00→03/02		Without Variable Valve Timing, Without Distributor, Black Boot, VVT Eng	2	2	U4001	48055
1.8		18K4F	09/95→03/02	With Bracket, To Ch. No.: YD522572	For Vehicles With Distributor	1	2	U1006	48059
1.8		18K4F	09/95→03/02	From Ch. No.: YD522573	For Vehicles Without Distributor, Black Boot, VVT Eng	2	2	U4001	48055
1.8, Trophy 160		18K4K	10/01→03/02		With Variable Valve Timing, Red Boot, Non VVT Eng	2	2	U4002	48100
1.8, VVC		18K4K	11/95→03/02		With Variable Valve Timing, Red Boot, Non VVT Eng	2	2	U4002	48100
MGR V8									
3.9			10/92→10/95		For Vehicles With Distributor	1	2	U1076	48339
MGTF									
1.6, 115		16K4F	03/02→12/07		For Vehicles Without Distributor, Black Boot, VVT Eng	2	2	U4001	48055
1.8, 120 Stepspeed		18K4F	03/02→12/07		Without Variable Valve Timing, Without Distributor, Black Boot, VVT Eng	2	2	U4001	48055
1.8, 135		18K4F	03/02→12/09		Without Variable Valve Timing, Without Distributor, Black Boot, VVT Eng	2	2	U4001	48055
1.8, 160 VVC		18K4K	03/02→12/07		With Variable Valve Timing, Red Boot, Non VVT Eng	2	2	U4002	48100
MGZR									
1.4, 105		14K4F	06/01→04/05	With Bracket, To Ch. No.: YD471564	For Vehicles With Distributor	1	2	U1006	48059
1.4, 105		14K4F	06/01→04/05	From Ch. No.: YD471565	For Vehicles Without Distributor, Black Boot, VVT Eng	2	2	U4001	48055
1.8, 120		18K4F	06/01→04/05	With Bracket, To Ch. No.: YD471564	Without Variable Valve Timing, With Distributor	1	2	U1006	48059
1.8, 120		18K4F	06/01→04/05	From Ch. No.: YD471565	Without Variable Valve Timing, Without Distributor, Black Boot, VVT Eng	2	2	U4001	48055
1.8, 160 VVC		18K4K	06/01→04/05	From Ch. No.: YD471565	With Variable Valve Timing, Red Boot, Non VVT Eng	2	2	U4002	48100
MGZS									
1.6, 110	Hbk	16K4F	08/03→10/05	With Bracket, To Ch. No.: YD471564	For Vehicles With Distributor	1	2	U1006	48059
1.6, 110	Hbk	16K4F	08/03→10/05	From Ch. No.: YD471565	For Vehicles Without Distributor, Black Boot, VVT Eng	2	2	U4001	48055
1.6, 110	Sal	16K4F	08/03→04/05		For Vehicles Without Distributor, Black Boot, VVT Eng	2	2	U4001	48055
1.8, 120	Hbk	18K4F	07/01→10/05	With Bracket, To Ch. No.: YD471564	For Vehicles With Distributor	1	2	U1006	48059

LITRE / MODEL	BODY	ENGINE TYPE	DATE	ADDITIONAL INFORMATION	FITMENT INFORMATION	NO. OF COILS	NO. OF PINS	PART NO.	STOCK NO.
MG (continued)									
MGZS									
1.8, 120	Hbk	18K4F	07/01→10/05	From Ch. No.: YD471565	For Vehicles Without Distributor, Black Boot, VVT Eng	2	2	U4001	48055
1.8, 120	Sal	18K4F	07/01→04/05	With Bracket, To Ch. No.: YD471564	For Vehicles With Distributor	1	2	U1006	48059
1.8, 120	Sal	18K4F	07/01→04/05	From Ch. No.: YD471565	For Vehicles Without Distributor, Black Boot, VVT Eng	2	2	U4001	48055
2.5, 180	Hbk	25K4F	07/01→10/05		2 Bolt Fixing	6	3	U5005	48009
2.5, 180	Hbk	25K4F	07/01→10/05		1 Bolt Fixing	6	3	U5026	48091
2.5, 180	Sal	25K4F	07/01→04/05		2 Bolt Fixing	6	3	U5005	48009
2.5, 180	Sal	25K4F	07/01→04/05		1 Bolt Fixing	6	3	U5026	48091
MGZT									
1.8, 120	Sal	18K4F	08/03→07/05		For Vehicles Without Distributor, Black Boot, VVT Eng	2	2	U4001	48055
1.8, T 160	Sal	18K4G	01/03→07/05		For Vehicles Without Distributor, Black Boot, VVT Eng	2	2	U4001	48055
2.5, 160	Sal	25K4F	06/01→03/04		2 Bolt Fixing	6	3	U5005	48009
2.5, 160	Sal	25K4F	06/01→03/04		1 Bolt Fixing	6	3	U5026	48091
2.5, 180 Automatic	Sal	25K4F	01/03→07/05		2 Bolt Fixing	6	3	U5005	48009
2.5, 180 Automatic	Sal	25K4F	01/03→07/05		1 Bolt Fixing	6	3	U5026	48091
2.5, 190	Sal	25K4F	06/01→07/05		2 Bolt Fixing	6	3	U5005	48009
2.5, 190	Sal	25K4F	06/01→07/05		1 Bolt Fixing	6	3	U5026	48091
MGZT-T									
1.8, 120	Est	18K4F	09/03→07/05		For Vehicles Without Distributor, Black Boot, VVT Eng	2	2	U4001	48055
1.8, T 160	Sal	18K4G	01/03→07/05		For Vehicles Without Distributor, Black Boot, VVT Eng	2	2	U4001	48055
2.5, 160	Est	25K4F	10/01→04/04		2 Bolt Fixing	6	3	U5005	48009
2.5, 160	Sal	25K4F	10/01→04/04		1 Bolt Fixing	6	3	U5026	48091
2.5, 180 Automatic	Est	25K4F	01/03→07/05		2 Bolt Fixing	6	3	U5005	48009
2.5, 180 Automatic	Sal	25K4F	01/03→07/05		1 Bolt Fixing	6	3	U5026	48091
2.5, 190	Est	25K4F	10/01→07/05		2 Bolt Fixing	6	3	U5005	48009
2.5, 190	Sal	25K4F	10/01→07/05		1 Bolt Fixing	6	3	U5026	48091
Midget MK 1									
1.1, MG	Cnv		01/64→12/64		For Vehicles With Distributor	1	2	U1079	48342
Midget MK 2									
1.1, MG	Cnv		10/64→12/66		For Vehicles With Distributor	1	2	U1079	48342
Midget MK 3									
1.3, MG 1275	Cnv		01/67→12/73		For Vehicles With Distributor	1	2	U1079	48342
Midget MK 4									
1.3, MG 1275	Cnv		10/73→09/74		For Vehicles With Distributor	1	2	U1079	48342
1.5, MG 1500	Cnv		01/75→12/79		For Vehicles With Distributor	1	2	U1056	48236

MINI									
MINI F55 (14→)									
1.5, Cooper		B38A15A	08/14→			3	3	U5322	49061
MINI F56 (14→)									
1.2, One		B38A12A	01/14→			3	3	U5322	49061
1.5, Cooper		B38A15A	01/14→			3	3	U5322	49061
MINI R50 (01→06)									
1.6, Cooper		W10B16A	04/01→12/06			1	3	U2073	48368
MINI R52 (04→09)									
1.6, Cooper		W10B16A	07/04→12/06			1	3	U2073	48368
1.6, Cooper S		W11B16A	01/07→05/09			1	3	U2073	48368
1.6, Cooper S Works		W11B16A	11/04→07/06			1	3	U2073	48368
MINI R53 (01→06)									
1.6, Cooper S		W11B16A	06/02→12/06			1	3	U2073	48368
1.6, Cooper S Works		W11B16A	03/03→09/04			1	3	U2073	48368

LITRE / MODEL	BODY	ENGINE TYPE	DATE	ADDITIONAL INFORMATION	FITMENT INFORMATION	NO. OF COILS	NO. OF PINS	PART NO.	STOCK NO.
MITSUBISHI (continued)									
Carisma (95→99)									
1.8	Hbk, Sal, Est	4G93	07/95→10/97		For Vehicles with Distributor	1	3	U1011	48090
1.8	Sal	4G93	09/96→10/97			2	3	U4014	48225
Carisma (99→05)									
1.6	Hbk	4G92	08/99→04/05			2	3	U4014	48225
1.6	Sal	4G92	08/99→12/01			2	3	U4014	48225
1.8	Hbk	4G93(GDI)	08/99→05/03			4	3	U4012	48210
1.8	Sal	4G93(GDI)	08/99→08/01			4	3	U4012	48210
Colt Mirage (84→88)									
1.2		4G16	06/84→09/86		For Vehicles With Distributor	1	2	U1056	48236
1.5		4G15	09/84→04/88		For Vehicles With Distributor	1	2	U1056	48236
Colt Mirage (88→92)									
1.5	Hbk	4G15	09/90→07/92			2	2	U3020	48374
1.6, GTi		4G61	07/88→04/90	With Bracket	For Vehicles Without Distributor	1	4	U2042	48189
Colt Mirage (92→95)									
1.6		4G92	04/92→04/96			2	3	U4014	48225
1.8, Gti			04/92→04/96			1	3	U1011	48090
Colt Mirage (04→)									
1.1	Hbk	3A91	10/04→06/10			3	3	U5101	48317
1.3	Hbk	4A90	08/04→06/10			4	3	U5101	48317
1.5	Hbk	4A91	08/04→12/09			4	3	U5101	48317
1.5, CZC	Cnv	4A91	05/06→12/09			4	3	U5101	48317
Galant (80→84)									
1.6	Sal	4G32	10/80→12/82		For Vehicles With Distributor	1	2	U1056	48236
2.0	Est	4G63(SOHC8V)	03/82→06/83			2	3	U4014	48225
2.0	Sal	4G63(SOHC8V)	10/80→05/84	With Bracket		1	2	U1022	48113
2.0	Sal	4G63(SOHC8V)	10/80→05/84	With Bracket	For Vehicles With Distributor	1	2	U1034	48152
2.0	Sal	4G63(SOHC8V)	10/80→05/84		For Vehicles With Distributor	1	2	U1056	48236
2.0	Sal	4G63(SOHC8V)	10/80→05/84			2	3	U4014	48225
2.0, Turbo	Sal	4G63T(ECI)	05/82→05/84	With Bracket		1	2	U1022	48113
2.0, Turbo	Sal	4G63T(ECI)	05/82→05/84	With Bracket	For Vehicles With Distributor	1	2	U1034	48152
2.0, Turbo	Sal	4G63T(ECI)	05/82→05/84		For Vehicles With Distributor	1	2	U1056	48236
2.0, Turbo	Sal	4G63T(ECI)	05/82→05/84			2	3	U4014	48225
Galant (84→88)									
1.6		4G32	07/84→12/87		For Vehicles With Distributor	1	2	U1056	48236
2.0		4G63(SOHC8V)	07/84→12/87	With Bracket		1	2	U1022	48113
2.0		4G63(SOHC8V)	07/84→12/87	With Bracket	For Vehicles With Distributor	1	2	U1034	48152
2.0		4G63(SOHC8V)	07/84→12/87		For Vehicles With Distributor	1	2	U1056	48236
2.0		4G63(SOHC8V)	07/84→12/87			2	3	U4014	48225
Galant (88→93)									
2.0	Cpe	4G63(DOHC16V)	04/90→12/92	With Bracket		1	2	U1022	48113
2.0	Cpe	4G63(DOHC16V)	04/90→12/92	With Bracket	For Vehicles With Distributor	1	2	U1034	48152
2.0	Cpe	4G63(DOHC16V)	04/90→12/92	With Bracket	For Vehicles Without Distributor	1	4	U2042	48189
2.0	Cpe	4G63(SOHC8V)	05/89→10/92	With Bracket		1	2	U1022	48113
2.0	Cpe	4G63(SOHC8V)	05/89→10/92	With Bracket	For Vehicles With Distributor	1	2	U1034	48152
2.0	Sal	4G63(DOHC16V)	06/88→10/92	With Bracket		1	2	U1022	48113
2.0	Sal	4G63(DOHC16V)	06/88→10/92	With Bracket	For Vehicles With Distributor	1	2	U1034	48152
2.0	Sal	4G63(DOHC16V)	06/88→10/92	With Bracket	For Vehicles Without Distributor	1	4	U2042	48189
2.0	Sal	4G63(SOHC8V)	03/88→10/92	With Bracket		1	2	U1022	48113
2.0	Sal	4G63(SOHC8V)	03/88→10/92	With Bracket	For Vehicles With Distributor	1	2	U1034	48152
Galant (93→97)									
2.0	Hbk, Sal	6A12	03/93→08/96	With Bracket		1	2	U1022	48113
2.0	Hbk, Sal	6A12	03/93→08/96	With Bracket	For Vehicles With Distributor	1	2	U1034	48152
Galant (97→03)									
2.0	Est, Sal	4G63(SOHC16V)	03/97→07/03			2	3	U4014	48225
Grandis									
2.4		4G69	07/04→12/09			4	3	U5148	48398

LITRE / MODEL	BODY	ENGINE TYPE	DATE	ADDITIONAL INFORMATION	FITMENT INFORMATION	NO. OF COILS	NO. OF PINS	PART NO.	STOCK NO.
MITSUBISHI (continued)									
L300 (85→01)									
1.6		4G32	01/85→04/94		For Vehicles With Distributor	1	2	U1056	48236
2.0		4G63(DOHC16V)	08/94→04/00		For Vehicles With Distributor	1	2	U1079	48342
Lancer (84→89)									
1.5	Est	4G15	10/85→12/87	With Bracket		1	2	U1022	48113
1.5	Est	4G15	10/85→12/87		For Vehicles With Distributor	1	2	U1056	48236
1.5	Sal	4G15	09/84→04/88	With Bracket		1	2	U1022	48113
Lancer (92→95)									
1.8, Gti	Hbk, Sal, Est	4G93	06/92→12/93			1	3	U1011	48090
Lancer (04→08)									
1.6	Sal	4G18	12/04→12/08			2	3	U4027	48375
2.0, Sport	Est	4G63	12/04→12/08			2	3	U4028	48376
2.0, Sport	Sal	4G63	07/06→12/08			2	3	U4028	48376
Lancer Evolution VIII									
2.0	Sal	4G63	02/04→07/05			2	3	U4028	48376
2.0, MR 280	Sal	4G63	03/03→02/04			2	3	U4031	48379
Lancer Evolution X									
2.0	Sal	4B11, 4B11TC	02/08→03/13	Inc FQ 300, 330, 360		4	3	U5210	49060
Outlander (→07)									
2.4		4G69	01/04→05/07			4	3	U5148	48398
Shogun (83→91)									
2.6		4G54	07/83→11/90		For Vehicles With Distributor	1	2	U1056	48236
2.6		4G54	07/83→11/90			1	2	U1084	48357
3.0		6G72(SOHC12V)	03/89→11/90			1	2	U1084	48357
Shogun (91→00)									
3.0		6G72(SOHC12V)	04/91→09/94			1	2	U1084	48357
3.0		6G72(SOHC24V)	06/97→03/00		For Cyl.: 1, 2, 4, 5, Black Connector	2	2	U3016	48228
3.5		6G74(DOHC24V), 6G74(SOHC24V)	05/97→10/97		For Cyl.: 1, 2, 4, 5, Black Connector	2	2	U3016	48228
Shogun (00→07);									
3.5		6G74(DOHC24V), 6G74(SOHC24V)	04/00→10/06			6	3	U4012	48210
Shogun Pinin (99→06)									
1.8	ATV/SUV	4G93(GDI)	12/99→12/06			4	3	U4012	48210
1.8	Van	4G93(GDI)	09/00→12/05			4	3	U4012	48210
2.0	ATV/SUV	4G94(GDI)	12/00→06/06			4	3	U4012	48210
2.0	Van	4G94(GDI)	12/00→12/05			4	3	U4012	48210
Space Star (98→02)									
1.8		4G93(GDI)	12/98→08/02			4	3	U4012	48210
Space Star (02→06)									
1.3		4G13, 4G1316, DG1A	07/02→12/06			2	3	U4027	48375
1.6		4G18	07/02→12/06			2	3	U4027	48375
1.8		4G93	11/03→07/05			2	3	U4027	48375
Space Wagon (91→98)									
2.0		4G63(DOHC16V)	10/92→10/98	With Bracket		1	2	U1022	48113
2.0		4G63(DOHC16V)	10/92→10/98	With Bracket	For Vehicles With Distributor	1	2	U1034	48152
2.0		4G63(DOHC16V)	10/92→10/98			2	3	U4014	48225
Space Wagon (98→04)									
2.0		4G63(DOHC16V)	04/02→07/04			2	3	U4014	48225
Starion (82→89)									
2.0		4G63T(ECI)	06/82→03/85	With Bracket		1	2	U1022	48113
2.0		4G63T/C	05/85→08/87	With Bracket		1	2	U1022	48113
Tredia (82→85)									
1.4		4G12	10/82→08/85		For Vehicles With Distributor	1	2	U1056	48236
1.6		4G32	10/82→10/85		For Vehicles With Distributor	1	2	U1056	48236

LITRE / MODEL	BODY	ENGINE TYPE	DATE	ADDITIONAL INFORMATION	FITMENT INFORMATION	NO. OF COILS	NO. OF PINS	PART NO.	STOCK NO.
MORGAN									
4/4 Ford Engine									
1.6			01/80→01/82		For Vehicles With Distributor	1	2	U1063	48300
1.6			01/80→01/82		For Vehicles With Distributor	1	2	U1065	48302
Plus 8 Rover Engine (Carburettor)									
3.5			01/80→12/86		For Vehicles With Distributor	1	2	U1076	48339
Plus 8 Rover Engine (Injection)									
3.5			03/84→06/90		For Vehicles With Distributor	1	2	U1076	48339

MORRIS - SEE AUSTIN/MORRIS

NISSAN									
100NX									
1.6, MPi		GA16DE	09/93→10/94	Oval Connector		1	2	U1024	48117
1.6, SPi		GA16DS	01/92→02/93	Oval Connector		1	2	U1024	48117
300ZX									
3.0, Turbo Targa		VG30DETT	03/94→12/94			6	3	U5106	48323
350Z									
3.5	Cpe	VQ35DE	04/06→12/06			6	3	U5123	48350
3.5	Cpe	VQ35DE	10/03→12/05			6	3	U5123	48350
3.5, Roadster	Cnv	VQ35DE	03/05→12/05			6	3	U5123	48350
3.5, Roadster	Cnv	VQ35DE	04/06→12/06			6	3	U5123	48350
720									
1.8		L18	01/85→03/86		For Vehicles With Distributor	1	2	U1056	48236
Almera 1									
1.4	Hbk	GA14DE	10/95→02/00	Oval Connector		1	2	U1024	48117
1.6	Hbk	GA16DE	10/95→02/00	Oval Connector		1	2	U1024	48117
1.6	Sal	GA16DE	05/96→02/00	Oval Connector		1	2	U1024	48117
Almera 2									
1.5	Hbk	QG15DE	03/00→10/00			4	3	U5032	48122
1.5	Hbk	QG15DE	10/00→12/06			4	3	U5036	48139
1.5	Hbk	QG15DE	10/02→12/06			4	3	U5032	48122
1.5	Sal	QG15DE	06/01→03/06			4	3	U5036	48139
1.5	Sal	QG15DE	10/02→03/06			4	3	U5032	48122
1.8	Hbk	QG18DE	02/00→10/00			4	3	U5032	48122
1.8	Hbk	QG18DE	10/00→03/06			4	3	U5036	48139
1.8	Hbk, Sal	QG18DE	10/02→03/06			4	3	U5032	48122
1.8	Hbk, Sal	QG18DE	10/02→03/06			4	3	U5036	48139
1.8	Sal	QG18DE	06/01→09/02			4	3	U5036	48139
1.8, Dual Fuel	Hbk	QG18DE	08/03→07/05			4	3	U5032	48122
1.8, Dual Fuel	Hbk	QG18DE	08/03→07/05			4	3	U5036	48139
1.8, Dual Fuel	Sal	QG18DE	01/04→07/05			4	3	U5032	48122
1.8, Dual Fuel	Sal	QG18DE	01/04→07/05			4	3	U5036	48139
Bluebird									
1.6	Hbk, Sal	CA16S	03/86→06/90			1	2	U1070	48307
1.8	Sal	CA18S	05/84→03/86			1	2	U1070	48307
1.8, 180B		L18S	05/80→12/83			1	2	U1070	48307
1.8, 180B		L18S	05/80→05/84			1	2	U1070	48307
2.0	Sal	CA20E	03/86→07/88	Oval Connector		1	2	U1024	48117
2.0	Sal	CA20E	03/86→07/88			1	2	U1070	48307
2.0	Est	CA20E	03/86→09/90	Oval Connector		1	2	U1024	48117
2.0	Est	CA20E	03/86→09/90			1	2	U1070	48307
2.0	Est, Sal	CA20E	05/84→03/86	Oval Connector		1	2	U1024	48117
2.0	Est, Sal	CA20E	05/84→03/86			1	2	U1070	48307
2.0, Injected	Hbk, Sal	CA20E	09/88→09/90	Oval Connector		1	2	U1024	48117
2.0, Injected	Hbk, Sal	CA20E	09/88→09/90			1	2	U1070	48307

LITRE / MODEL	BODY	ENGINE TYPE	DATE	ADDITIONAL INFORMATION	FITMENT INFORMATION	NO. OF COILS	NO. OF PINS	PART NO.	STOCK NO.
NISSAN (continued)									
Cherry									
1.3	Est, Hbk	E13	10/81→09/82			1	2	U1070	48307
1.3		E13	09/82→09/86			1	2	U1070	48307
Cube									
1.6		HR16DE	03/10→06/11			4	3	U5043	48162
Juke									
1.6, DIG-T		MR16DDT	10/10→			4	3	U5147	48397
1.6, DIG-T 4x4		MR16DDT	10/10→			4	3	U5147	48397
Kubistar									
1.2		D7F764	10/03→12/05	Oval Connector	For Vehicles Without Distributor	1	4	U2007	48026
Maxima/QX A31									
3.0		VG30E	06/89→06/94	Oval Connector		1	2	U1024	48117
Maxima/QX A32									
3.0		VQ30DE	03/95→08/00		For Cyl.: 1, 2, 3	3	3	U5111	48331
3.0		VQ30DE	03/95→08/00		For Cyl.: 4, 5, 6	3	3	U5113	48333
Maxima/QX A33									
2.0		VQ20DE	10/00→12/02		For Cyl.: 4, 5, 6	3	3	U5110	48330
2.0		VQ20DE	10/00→12/02		For Cyl.: 1, 2, 3	3	3	U5111	48331
3.0		VQ30DE	10/00→12/02		For Cyl.: 4, 5, 6	3	3	U5110	48330
3.0		VQ30DE	10/00→12/02		For Cyl.: 1, 2, 3	3	3	U5111	48331
Micra									
1.2		HR12DE	09/10→			3	3	U5119	48347
Micra K10									
1.0		MA10S	06/83→12/89		For Vehicles With Distributor	1	2	U1056	48236
1.0		MA10S	06/83→12/89			1	2	U1070	48307
1.2		MA12S	03/89→07/92			1	2	U1070	48307
Micra K11									
1.0		CG10DE	09/00→02/03			4	3	U5041	48155
1.4		CGA3DE	09/00→02/03			4	3	U5041	48155
Micra K12									
1.0	Hbk	CG10DE	01/03→09/05			4	3	U5041	48155
1.0	Hbk	CG10DE	01/03→09/05			4	3	U5054	48201
1.2	Hbk	CG12DE, CR12DE	01/03→04/11			4	3	U5054	48201
1.4	Hbk	CR14DE	01/03→12/10			4	3	U5054	48201
1.4, C+C	Cnv	CR14DE	09/05→12/09			4	3	U5054	48201
1.6	Hbk	HR16DE	07/05→12/09			4	3	U5043	48162
1.6, C+C	Cnv	HR16DE	09/05→12/09			4	3	U5043	48162
Murano									
3.5		VQ35DE	10/04→12/08			6	3	U5112	48332
Note									
1.4		CR14DE	03/06→			4	3	U5054	48201
1.6		HR16DE	03/06→			4	3	U5043	48162
Pathfinder									
4.0		VQ40DE	09/05→05/07			6	3	U5112	48332
Prairie									
1.5		E15S	01/84→09/87			1	2	U1070	48307
1.8		CA18S	05/84→10/87			1	2	U1070	48307
Primastar									
2.0		F4R720	02/03→12/06			4	2	U5001	48002
Primera P10									
1.6, Carburettor	Hbk, Sal	GA16DS	09/90→12/91	Oval Connector		1	2	U1024	48117
1.6, MPi	Hbk, Sal	GA16DE	06/93→01/96	Oval Connector		1	2	U1024	48117
1.6, SPi	Hbk, Sal	GA16DS	01/92→06/93	Oval Connector		1	2	U1024	48117
2.0	Hbk, Sal	SR20DE	01/95→06/96	Oval Connector		1	2	U1024	48117
2.0	Hbk, Sal	SR20DE	09/90→06/93	Oval Connector		1	2	U1024	48117
2.0, eZX	Hbk, Sal	SR20DE	09/90→01/96	Oval Connector		1	2	U1024	48117

LITRE / MODEL	BODY	ENGINE TYPE	DATE	ADDITIONAL INFORMATION	FITMENT INFORMATION	NO. OF COILS	NO. OF PINS	PART NO.	STOCK NO.
NISSAN (continued)									
Primera P11									
1.6	Hbk, Sal	GA16DE	10/96→09/99	Oval Connector		1	2	U1024	48117
2.0	Hbk, Sal	SR20DE	10/96→09/99	Oval Connector		1	2	U1024	48117
Primera P11-144									
1.6	Hbk	GA16DE	09/99→05/02	Oval Connector		1	2	U1024	48117
1.6	Sal	GA16DE	09/99→10/00	Oval Connector		1	2	U1024	48117
1.8	Hbk	QG18DE	09/99→05/02			4	3	U5032	48122
1.8	Hbk	QG18DE	09/99→05/02			4	3	U5036	48139
1.8	Sal	QG18DE	09/99→12/01			4	3	U5032	48122
1.8	Sal	QG18DE	09/99→12/01			4	3	U5036	48139
1.8, Dual Fuel	Hbk	QG18DE	10/00→05/02			4	3	U5032	48122
1.8, Dual Fuel	Hbk	QG18DE	10/00→05/02			4	3	U5036	48139
2.0	Hbk	SR20DE	09/99→05/02	Oval Connector		1	2	U1024	48117
2.0	Sal	SR20DE	09/99→12/01	Oval Connector		1	2	U1024	48117
Primera P12									
1.8	Hbk	QG18DE	09/02→12/06			4	3	U5032	48122
1.8	Hbk	QG18DE	09/02→12/06			4	3	U5036	48139
1.8	Sal	QG18DE	03/02→12/04			4	3	U5032	48122
1.8	Sal	QG18DE	03/02→12/04			4	3	U5036	48139
1.8, Dual Fuel	Hbk	QG18DE	04/03→07/05			4	3	U5032	48122
1.8, Dual Fuel	Hbk	QG18DE	04/03→07/05			4	3	U5036	48139
1.8, Dual Fuel	Sal	QG18DE	04/03→12/04			4	3	U5032	48122
1.8, Dual Fuel	Sal	QG18DE	04/03→12/04			4	3	U5036	48139
2.0	Hbk	QR20DE	09/02→03/06			4	3	U5061	48226
2.0	Sal	QR20DE	03/02→12/04			4	3	U5061	48226
Primera W10									
1.6, MPI		GA16DE	03/94→10/96	Oval Connector		1	2	U1024	48117
1.6, SPi		GA16DS	01/92→06/93	Oval Connector		1	2	U1024	48117
2.0		SR20DI	02/91→10/96	Oval Connector		1	2	U1024	48117
Primera W11									
1.6		GA16DE	04/98→12/01	Oval Connector		1	2	U1024	48117
1.8		QG18DE	09/99→12/01			4	3	U5032	48122
1.8		QG18DE	09/99→12/01			4	3	U5036	48139
1.8, Dual Fuel		QG18DE	10/00→12/01			4	3	U5032	48122
1.8, Dual Fuel		QG18DE	10/00→12/01			4	3	U5036	48139
Primera W12									
1.8		QG18DE	03/02→12/06			4	3	U5032	48122
1.8		QG18DE	03/02→12/06			4	3	U5036	48139
1.8, Dual Fuel		QG18DE	04/03→07/05			4	3	U5032	48122
1.8, Dual Fuel		QG18DE	04/03→07/05			4	3	U5036	48139
2.0		QR20DE	03/02→03/06			4	3	U5061	48226
Qashqai									
1.6		HR16DE	03/07→			4	3	U5043	48162
2.0		MR20DE	03/07→			4	3	U5043	48162
2.0, Qashqai + 2		MR20DE	07/08→			4	3	U5043	48162
Serena									
2.0		SR20DE	01/93→09/00	Oval Connector		1	2	U1024	48117
Stanza									
1.6	Hbk, Sal	CA16S	01/82→12/85		For Vehicles With Distributor	1	2	U1056	48236
1.8	Hbk	CA18, CA18S	01/82→12/85		For Vehicles With Distributor	1	2	U1056	48236
Sunny B11									
1.3	Sal	E13	05/82→09/86			1	2	U1070	48307
1.5	Cpe, Est	E15S	05/82→09/86			1	2	U1070	48307
1.5	Sal	E15S	09/82→09/86			1	2	U1070	48307
Sunny B12									
1.6	Cpe	E16S	09/86→10/88			1	2	U1070	48307
1.6	Est	E16S	09/86→10/88			1	2	U1070	48307

LITRE / MODEL	BODY	ENGINE TYPE	DATE	ADDITIONAL INFORMATION	FITMENT INFORMATION	NO. OF COILS	NO. OF PINS	PART NO.	STOCK NO.
NISSAN (continued)									
Sunny N13									
1.3	Hbk	E13S	09/86→10/88			1	2	U1070	48307
1.3	Sal	E13S	09/86→08/88			1	2	U1070	48307
1.6	Hbk, Sal	E16S	09/86→02/88			1	2	U1070	48307
Sunny N14									
1.4	Hbk	GA14DE	12/91→02/93	Oval Connector		1	2	U1024	48117
1.4, MPi	Hbk	GA14DE	02/93→05/95	Oval Connector		1	2	U1024	48117
1.4, MPi	Hbk, Sal	GA14DE	02/93→06/95	Oval Connector		1	2	U1024	48117
1.6, MPi	Hbk, Sal	GA16DE	02/93→05/95	Oval Connector		1	2	U1024	48117
2.0, e GTi	Hbk	SR20DE	01/92→08/94	Oval Connector		1	2	U1024	48117
2.0, GTi-R	Hbk	SR20DET	04/92→12/93	Oval Connector		1	2	U1024	48117
Terrano II									
2.4		KA24E	07/93→12/01	Oval Connector		1	2	U1024	48117
Tino									
1.8		QG18DE	08/00→03/06			4	3	U5032	48122
1.8		QG18DE	08/00→03/06			4	3	U5036	48139
1.8, Dual Fuel		QG18DE	08/03→07/05			4	3	U5032	48122
1.8, Dual Fuel		QG18DE	08/03→07/05			4	3	U5036	48139
Vanette									
1.5		A15S	10/86→06/95		For Vehicles With Distributor	1	2	U1056	48236
X-Trail									
2.0		MR20DE	06/07→12/09			4	3	U5043	48162
2.5		QR25DE	06/07→12/09			4	3	U5061	48226
X-Trail T30									
2.0		QR20DE	10/01→12/07			4	3	U5061	48226
2.5		QR25DE	04/03→12/07			4	3	U5061	48226

OPEL									
Ascona B (75→81)									
1.6		16N	01/80→08/81		For Vehicles With Distributor	1	2	U1064	48301
2.0		20S	01/80→08/81		For Vehicles With Distributor	1	3	U1010	48069
Kadett D (79→84)									
1.2	Est, Hbk	12N	01/80→07/82		For Vehicles With Distributor	1	3	U1010	48069
1.2	Est, Hbk	12N	01/80→07/82		For Vehicles With Distributor	1	2	U1064	48301
1.3, GL/S/SR	Est, Hbk, Sal	13S	01/80→12/82	With Bracket	For Vehicles With Distributor	1	4	U1002	48029
1.3, L/LS/N	Est, Hbk	13N	01/80→12/82	With Bracket	For Vehicles With Distributor	1	4	U1002	48029
1.3, L/LS/N	Sal	C13N	01/80→12/82	With Bracket	For Vehicles With Distributor	1	4	U1002	48029
1.6	Hbk	16SH	12/81→07/83		For Vehicles With Distributor	1	2	U1069	48306
Manta									
1.8	Cpe	18S	09/82→12/86		For Vehicles With Distributor	1	2	U1069	48306
1.8	Hbk	18S	09/82→08/87		For Vehicles With Distributor	1	2	U1069	48306
2.0	Cpe	20E	07/83→12/87		Conventional Coil Ignition (CI), With Distributor	1	2	U1064	48301
2.0	Cpe	20E	07/83→12/87		Electronic Ignition (EI), With Distributor	1	2	U1069	48306
2.0	Cpe, Hbk	20S	01/80→12/82		For Vehicles With Distributor	1	3	U1010	48069
2.0	Cpe, Hbk	20S	01/80→12/82		For Vehicles With Distributor	1	2	U1064	48301
2.0	Hbk	20E	07/83→08/88		Conventional Coil Ignition (CI), With Distributor	1	2	U1064	48301
2.0	Hbk	20E	07/83→08/88		Electronic Ignition (EI), With Distributor	1	2	U1069	48306
Rekord E (77→83)									
2.0	Est, Sal	20S	01/80→07/83		For Vehicles With Distributor	1	3	U1010	48069
2.0	Est, Sal	20S	01/80→07/83		For Vehicles With Distributor	1	2	U1064	48301
Senator A (80→84)									
2.5		H25E	01/83→08/84		For Vehicles With Distributor	1	2	U1069	48306
3.0, Injection		30E	01/80→12/84		For Vehicles With Distributor	1	2	U1069	48306

LITRE / MODEL	BODY	ENGINE TYPE	DATE	ADDITIONAL INFORMATION	FITMENT INFORMATION	NO. OF COILS	NO. OF PINS	PART NO.	STOCK NO.
PEUGEOT									
106 (91→96)									
1.0		CDY(TU9M)	07/92→12/92		For Vehicles Without Distributor	1	4	U2017	48067
1.0		CDZ(TU9M)	12/92→04/96		For Vehicles Without Distributor	1	4	U2017	48067
1.0		TU9	09/91→06/92	Angular Connector	For Vehicles With Distributor	1	4	U1009	48066
1.1, Carburettor		HDZ(TU1M)	09/91→07/92	Angular Connector	For Vehicles With Distributor	1	4	U1009	48066
1.1, Injection		HDZ(TU1M)	08/92→04/96		For Vehicles Without Distributor	1	4	U2017	48067
1.1, Injection		HDZ(TU1M)	09/91→07/92	Angular Connector	For Vehicles With Distributor	1	4	U1009	48066
1.3		TU2J2	01/94→04/96		For Vehicles Without Distributor	1	4	U2017	48067
1.4, Carburettor		KDX(TU3MC)	09/91→08/92		For Vehicles Without Distributor	1	4	U2017	48067
1.4, Carburettor		KDY(TU3M)	09/91→08/92	Angular Connector	For Vehicles With Distributor	1	4	U1009	48066
1.4, Injection		KDX(TU3MC)	09/91→04/96		For Vehicles Without Distributor	1	4	U2017	48067
1.4, Injection		KDY(TU3M)	09/91→04/96	Angular Connector	For Vehicles With Distributor	1	4	U1009	48066
1.4, XSi		KFZ(TU3J2/Z)	09/91→07/94		For Vehicles Without Distributor	1	4	U2017	48067
1.6		NFZ(TU5JP)	08/94→04/96		For Vehicles Without Distributor	1	4	U2017	48067
106 (96→03)									
1.1		HDZ(TU1M)	06/96→03/03	Angular Connector	For Vehicles With Distributor	1	4	U1009	48066
1.1		HDZ(TU1M)	06/96→03/03		For Vehicles Without Distributor	1	4	U2009	48030
1.1		HFX(TU1JP)	03/00→03/03	White Connector		1	4	U6005	48016
1.4		KFW(TU3JP), KFX(TU3JP)	03/98→03/03	Black Connector		1	4	U6008	48023
1.4		KFW(TU3JP), KFX(TU3JP)	06/96→02/98		For Vehicles Without Distributor	1	4	U2009	48030
1.6		NFZ(TU5JP)	06/96→05/99		For Vehicles Without Distributor	1	4	U2009	48030
1.6, GTi		NFX(TU5J4)	01/97→12/00	Black Connector		1	4	U6011	48045
1.6, GTi		NFX(TU5J4)	01/01→03/03	Grey Connector		1	4	U6017	48076
1.6, Rally		NFW(TU5J2)	10/97→04/98		For Vehicles Without Distributor	1	4	U2017	48067
107 (05→)									
1.0		1KR(384F)	07/05→			3	4	U5029	48107
205 (83→97)									
1.0	Hbk	108C(XV8), TU9	10/83→12/91		For Vehicles With Distributor	1	2	U1076	48339
1.0	Hbk	108C(XV8), TU9	10/87→12/91	Oval Connector	For Vehicles With Distributor	1	4	U1007	48062
1.0	Hbk	108C(XV8), TU9	10/87→12/91	Angular Connector	For Vehicles With Distributor	1	4	U1009	48066
1.0	Hbk	108C(XV8), TU9	10/87→12/91		For Vehicles Without Distributor	1	4	U2017	48067
1.1	Hbk	109F(XW7)	10/83→10/87	Oval Connector, With Bracket	For Vehicles With Distributor	1	4	U1029	48132
1.1	Hbk	109F(XW7)	10/83→10/87		For Vehicles With Distributor	1	2	U1076	48339
1.1	Hbk	H1B(TU1)	01/88→10/90	Oval Connector	For Vehicles With Distributor	1	4	U1007	48062
1.1	Hbk	H1B(TU1)	01/88→10/90		For Vehicles With Distributor	1	2	U1076	48339
1.1	Van	H1B(TU1)	11/87→07/90	Oval Connector	For Vehicles With Distributor	1	4	U1007	48062
1.1	Van	H1B(TU1)	11/87→07/90		For Vehicles With Distributor	1	2	U1076	48339
1.1	Van		01/85→07/87	Oval Connector, With Bracket	For Vehicles With Distributor	1	4	U1029	48132
1.1	Van		01/85→07/87		For Vehicles With Distributor	1	2	U1076	48339
1.1, Injection	Hbk	HDZ(TU1M)	08/91→02/96	Oval Connector	For Vehicles With Distributor	1	4	U1007	48062
1.1, Injection	Hbk	HDZ(TU1M)	08/91→02/96	Angular Connector	For Vehicles With Distributor	1	4	U1009	48066
1.1, Injection	Hbk	HDZ(TU1M)	08/91→02/96		For Vehicles Without Distributor	1	4	U2009	48030
1.1, Injection	Hbk	HDZ(TU1M)	08/91→02/96		For Vehicles Without Distributor	1	4	U2017	48067
1.4, Catalyst	Cnv	KDY(TU3M), KDZ(TU3M)	10/91→12/94	Oval Connector	For Vehicles With Distributor	1	4	U1007	48062
1.4, Catalyst	Hbk	KDX(TU3MC)	09/92→10/94	To Eng. No.: 1808178	For Vehicles Without Distributor	1	4	U2017	48067
1.4, Catalyst	Hbk	TU32	10/91→10/94	Oval Connector	For Vehicles With Distributor	1	4	U1007	48062
1.4, GR/XR/Roland Garros	Hbk	KDX(TU3MC)	09/92→12/92	To Eng. No.: 1808178	For Vehicles Without Distributor	1	4	U2017	48067
1.4, GR/XR/Roland Garros	Hbk	TU32	08/90→12/92	Oval Connector	For Vehicles With Distributor	1	4	U1007	48062
1.4, GR/XT/XS/Lacoste	Hbk	150D(XY7), 150G(XY7), KAY(TU3CP)	08/87→12/88	Oval Connector	For Vehicles With Distributor	1	4	U1007	48062
1.4, GR/XT/XS/Lacoste	Hbk	150D(XY7), 150G(XY7), KAY(TU3CP)	10/83→12/88		For Vehicles With Distributor	1	2	U1076	48339
1.4, GT/Lacoste II	Hbk	150B(XY8)	10/83→10/87		For Vehicles With Distributor	1	2	U1076	48339
1.4, SR/GT/XS	Hbk	K2B(TU3S)	06/87→12/89	Oval Connector	For Vehicles With Distributor	1	4	U1007	48062
1.6, Carburettor	Hbk		10/87→12/92		For Vehicles With Distributor	1	2	U1076	48339
1.6, Catalyst	Hbk	171(XU5S), BDY(XU5M2Z), BDY(XU5M3Z)	10/91→04/97		For Vehicles Without Distributor	1	4	U2009	48030
1.6, GTi	Hbk	180A(XU5J)	12/84→10/87	Oval Connector	For Vehicles With Distributor	1	4	U1007	48062
1.6, GTi	Hbk	180A(XU5J)	12/84→10/87		For Vehicles With Distributor	1	2	U1076	48339

LITRE / MODEL	BODY	ENGINE TYPE	DATE	ADDITIONAL INFORMATION	FITMENT INFORMATION	NO. OF COILS	NO. OF PINS	PART NO.	STOCK NO.
PEUGEOT (continued)									
205 (83→97)									
1.9, Gentry	Hbk	DFZ(XU9J1)	03/92→07/94	Oval Connector	For Vehicles With Distributor	1	4	U1007	48062
1.9, Gentry	Hbk	DFZ(XU9J1)	03/92→07/94		For Vehicles With Distributor	1	2	U1076	48339
1.9, GTi	Hbk	D6B(XU9JA)	01/87→12/92	Oval Connector	For Vehicles With Distributor	1	4	U1007	48062
1.9, GTi	Hbk	D6B(XU9JA)	01/87→12/92		For Vehicles With Distributor	1	2	U1076	48339
1.9, GTi (Catalyst)	Hbk	D6B(XU9JA)	03/92→07/94	Oval Connector	For Vehicles With Distributor	1	4	U1007	48062
1.9, GTi (Catalyst)	Hbk	D6B(XU9JA)	03/92→07/94		For Vehicles With Distributor	1	2	U1076	48339
206 (98→09)									
1.1	Hbk	HFX(TU1JP), HFZ(TU1JP)	06/00→03/06	White Connector		1	4	U6005	48016
1.1	Hbk	HFX(TU1JP), HFZ(TU1JP)	10/98→06/00	Black Connector		1	4	U6008	48023
1.1, sw	Est	HFX(TU1JP)	07/02→04/05	White Connector		1	4	U6005	48016
1.1, sw	Est	HFX(TU1JP)	07/02→04/05	Black Connector		1	4	U6008	48023
1.4	Hbk	KFU(ET3J4)	10/03→08/06			1	6	U6021	48124
1.4	Hbk	TU3A	10/05→12/09			1	4	U6015	48074
1.4	Hbk	TU3JP	06/00→10/05	White Connector		1	4	U6005	48016
1.4	Hbk	TU3JP	10/98→06/00	Black Connector		1	4	U6008	48023
1.4, sw	Est	KFU(ET3J4)	10/03→04/05			1	6	U6021	48124
1.4, sw	Est	KFV(TU3A)	07/02→08/07			1	4	U6015	48074
1.4, sw	Est	KFW(TU3JP)	07/02→08/07	White Connector		1	4	U6005	48016
1.4, sw	Est	KFW(TU3JP)	07/02→08/07	Black Connector		1	4	U6008	48023
1.6	Hbk	NFU(TU5JP4)	12/00→08/08	Grey Connector		1	4	U6004	48014
1.6	Hbk	NFZ(TU5JP)	10/98→10/00	Black Connector		1	4	U6008	48023
1.6, cc	Cnv	NFU(TU5JP4)	12/00→12/07	Grey Connector		1	4	U6004	48014
1.6, sw	Est	NFU(TU5JP4)	07/02→03/06	Grey Connector		1	4	U6004	48014
2.0	Hbk	RFN(EW10J4)	10/00→11/05			1	4	U6009	48032
2.0, CC	Cnv	RFN(EW10J4)	10/00→12/07			1	4	U6009	48032
2.0, GTi 180	Hbk	RFK(EW10J4S)	07/03→08/06			1	6	U6014	48072
2.0, sw	Est	RFN(EW10J4)	01/03→02/04			1	4	U6009	48032
207 (06→)									
1.4	Hbk	KFU(ET3J4)	07/06→05/08			1	6	U6021	48124
1.4	Hbk	KFV(TU3A)	12/07→02/05	Incl. Spark Plug Connector		1	4	U6015	48074
1.4, sw VTi 95	Est	EP3	08/07→			4	3	U5055	48206
1.4, VTi 95	Hbk	EP3(TU3E5)	08/07→03/13			4	3	U5055	48206
1.6	Hbk	NFU(TU5JP4)	07/06→10/07	Grey Connector		1	4	U6004	48014
1.6, GT	Hbk	EP6DT	11/06→04/10			4	3	U5055	48206
1.6, GTi THP 175	Hbk	EP6DT, EP6DTS	05/07→12/10			4	3	U5055	48206
1.6, sw VTi 120	Est	EP6	08/07→			4	3	U5055	48206
1.6, THP 150	Cnv	EP6DT	03/07→12/10			4	3	U5055	48206
1.6, THP 156	Cnv	EP6DT	06/10→			4	3	U5055	48206
1.6, VTi 120	Cnv	EP6	03/07→			4	3	U5055	48206
1.6, VTi 120	Hbk	EP6	08/07→			4	3	U5055	48206
208 (12→)									
1.4, VTi 95			04/12→			4	3	U5055	48206
1.6, THP			04/12→			4	3	U5055	48206
1.6, VTi 120			04/12→			4	3	U5055	48206
305 (77→90)									
1.5	Est	142(XR5)	10/80→08/86		For Vehicles With Distributor	1	2	U1076	48339
1.5	Est	142(XR5)	10/80→08/86		For Vehicles With Distributor	1	2	U1079	48342
1.5	Sal	142(XR5)	01/80→08/85		For Vehicles With Distributor	1	2	U1076	48339
1.5	Sal	142(XR5)	01/80→08/85		For Vehicles With Distributor	1	2	U1079	48342
1.6, Twin Choke Carburettor	Est	171(XU5S)	09/83→06/84		For Vehicles With Distributor	1	2	U1076	48339
1.6, Twin Choke Carburettor	Sal	171(XU5S)	08/83→06/87		For Vehicles With Distributor	1	2	U1076	48339
1.9	Est	159(XU9S)	10/84→10/87		For Vehicles With Distributor	1	2	U1076	48339
1.9	Sal	159(XU9S)	10/84→08/85		For Vehicles With Distributor	1	2	U1076	48339
306 (93→03)									
1.4	Est	KFW(TU3JP), KFX(TU3JP)	10/97→05/98		For Vehicles Without Distributor	1	4	U2009	48030
1.4	Est	KFX(TU3JP)	06/98→12/01	Black Connector		1	4	U6008	48023

LITRE / MODEL	BODY	ENGINE TYPE	DATE	ADDITIONAL INFORMATION	FITMENT INFORMATION	NO. OF COILS	NO. OF PINS	PART NO.	STOCK NO.
PEUGEOT (continued)									
306 (93→03)									
1.4	Est	KFX(TU3JP)	10/97→12/01	White Connector		1	4	U6005	48016
1.4	Hbk	KDX(TU3MC)	05/93→05/01		For Vehicles Without Distributor	1	4	U2017	48067
1.4	Hbk	KFW(TU3JP), KFX(TU3JP)	05/93→05/98		For Vehicles Without Distributor	1	4	U2009	48030
1.4	Hbk	KFX(TU3JP)	05/93→05/01	White Connector		1	4	U6005	48016
1.4	Hbk	KFX(TU3JP)	06/98→05/01	Black Connector		1	4	U6008	48023
1.4	Sal	KDX(TU3MC)	06/95→12/96		For Vehicles Without Distributor	1	4	U2017	48067
1.4	Sal	KFW(TU3JP), KFX(TU3JP)	06/95→12/96		For Vehicles Without Distributor	1	4	U2009	48030
1.4	Sal	KFX(TU3JP)	06/95→12/96	White Connector		1	4	U6005	48016
1.6	Cnv	NFT	12/00→04/02	White Connector		1	4	U6005	48016
1.6	Est	NFT	10/00→12/01	White Connector		1	4	U6005	48016
1.6	Est	NFZ(TU5JP)	10/97→05/98		For Vehicles Without Distributor	1	4	U2009	48030
1.6	Est, Hbk	NFZ(TU5JP)	06/98→10/00	Black Connector		1	4	U6008	48023
1.6	Hbk	NFT	10/00→05/01	White Connector		1	4	U6005	48016
1.6	Hbk	NFZ(TU5JP)	05/93→04/97		For Vehicles Without Distributor	1	4	U2017	48067
1.6	Hbk, Sal	NFZ(TU5JP)	05/97→05/98		For Vehicles Without Distributor	1	4	U2009	48030
1.6	Sal	NFZ(TU5JP)	06/98→07/99	Black Connector		1	4	U6008	48023
1.6	Sal	NFZ(TU5JP)	10/94→04/97		For Vehicles Without Distributor	1	4	U2017	48067
1.8	Cnv	LFY(XU7JP4)	03/97→09/97			1	4	U6040	48405
1.8	Cnv	LFY(XU7JP4)	09/97→04/02			1	4	U6012	48051
1.8	Est	LFY(XU7JP4)	03/97→12/97			1	4	U6040	48405
1.8	Est	LFY(XU7JP4)	01/98→12/01			1	4	U6012	48051
1.8	Hbk	LFY(XU7JP4)	03/97→12/97			1	4	U6040	48405
1.8	Hbk	LFY(XU7JP4)	01/98→05/01			1	4	U6012	48051
1.8	Hbk	LFZ(XU7JP)	05/93→12/98		For Vehicles Without Distributor	1	4	U2009	48030
1.8	Sal	LFY(XU7JP4)	03/97→12/97			1	4	U6040	48405
1.8	Sal	LFY(XU7JP4)	01/98→07/99			1	4	U6012	48051
1.8	Sal	LFZ(XU7JP)	10/95→04/97		For Vehicles Without Distributor	1	4	U2009	48030
2.0	Cnv	RFV(XU10J4R)	09/97→05/00			1	4	U6012	48051
2.0	Cnv	RFV(XU10J4R)	03/97→09/97			1	4	U6040	48405
2.0	Cnv	RFX(XU10J2)	05/94→06/97		For Vehicles Without Distributor	1	4	U2009	48030
2.0	Cnv	RFV(XU10J4R)	01/00→06/01			1	4	U6012	48051
2.0	Hbk	RFX(XU10J2)	01/94→06/97		For Vehicles Without Distributor	1	4	U2009	48030
2.0	Sal	RFX(XU10J2)	10/94→12/96		For Vehicles Without Distributor	1	4	U2009	48030
2.0, GTi-6	Hbk	RFS(XU10J4RS)	07/96→05/01			4	2	U5021	48073
2.0, Roadster	Cnv	RFV(XU10J4R)	04/97→12/99			1	4	U6012	48051
2.0, Roadster	Cnv	RFX(XU10J2)	07/96→06/97		For Vehicles Without Distributor	1	4	U2009	48030
2.0, S16	Hbk	RFY(XU10J4Z)	01/94→09/97			4	3	U5044	48163
2.0, XSi	Hbk	RFV(XU10J4R)	04/97→05/01			1	4	U6012	48051
307 (01→09)									
1.4	Est	KFW(TU3JP)	03/02→01/04	White Connector		1	4	U6005	48016
1.4	Hbk	KFU(ET3J4)	11/03→12/08			1	6	U6021	48124
1.4	Hbk	KFW(TU3JP)	04/01→01/04	White Connector		1	4	U6005	48016
1.6	Est	NFU(TU5JP4)	03/02→03/09	Grey Connector		1	4	U6004	48014
1.6	Hbk	NFU(TU5JP4)	04/01→12/08	Grey Connector		1	4	U6004	48014
1.6, sw	Est	NFU(TU5JP4)	03/02→03/09	Grey Connector		1	4	U6004	48014
2.0	Est	RFN(EW10J4)	11/02→06/05			1	4	U6009	48032
2.0	Hbk	RFN(EW10J4)	04/01→06/05			1	4	U6009	48032
2.0, 140 Sport	Hbk	RFJ(EW10A)	04/05→12/08			1	6	U6013	48071
2.0, 180 GT	Hbk	RFK(EW10J4S)	09/05→12/07			1	6	U6014	48072
2.0, sw	Est	RFJ(EW10A)	03/05→08/06			1	4	U6009	48032
2.0, sw	Est	RFJ(EW10A)	03/05→08/06			1	6	U6013	48071
307 (03→09)									
1.6, cc		NFU(TU5JP4)	03/05→03/09	Grey Connector		1	4	U6004	48014
2.0, CC		RFJ(EW10A), RFN(EW10J4)	03/05→07/05			1	6	U6013	48071
2.0, CC		RFJ(EW10A), RFN(EW10J4)	10/03→07/05			1	4	U6009	48032
2.0, CC		RFK(EW10J4S)	10/03→10/08			1	6	U6014	48072
2.0, CC		RFN(EW10J4)	06/05→03/09			1	4	U6009	48032

LITRE / MODEL	BODY	ENGINE TYPE	DATE	ADDITIONAL INFORMATION	FITMENT INFORMATION	NO. OF COILS	NO. OF PINS	PART NO.	STOCK NO.
PEUGEOT (continued)									
308 (07→)									
1.4, sw VTi 95	Est	8FS(EP3)	06/08→12/09			4	3	U5055	48206
1.4, sw VTi 98	Est		06/11→			4	3	U5055	48206
1.4, VTi 95	Hbk	EP3	09/07→12/10			4	3	U5055	48206
1.4, VTi 98	Hbk		06/10→			4	3	U5055	48206
1.6, cc THP 140 Automatic	Cnv	5FT(EP6DT)	06/09→05/10			4	3	U5055	48206
1.6, cc THP 150	Cnv	5FX(EP6DT)	06/09→08/10			4	3	U5055	48206
1.6, cc THP 156	Cnv	EP6CDT	12/09→			4	3	U5055	48206
1.6, cc VTi 120	Cnv	EP6	06/09→			4	3	U5055	48206
1.6, GT THP 175	Hbk	5FY(EP6DTS)	04/08→12/10			4	3	U5055	48206
1.6, GT THP 200	Hbk	EP6CDTX	07/10→			4	3	U5055	48206
1.6, sw GT THP 175	Est	5FY(EP6DTS)	06/08→12/10			4	3	U5055	48206
1.6, sw THP 140 Automatic	Est	5FT(EP6DT)	06/08→12/10			4	3	U5055	48206
1.6, sw THP 150 Manual	Est	5FX(EP6DT)	06/08→12/10			4	3	U5055	48206
1.6, sw THP 156	Est	EP6CDT	04/10→			4	3	U5055	48206
1.6, sw VTi 120	Est	EP6	06/08→			4	3	U5055	48206
1.6, THP 140 Automatic	Hbk	5FT(EP6DT)	09/07→12/10			4	3	U5055	48206
1.6, THP 150 Manual	Hbk	5FX(EP6DT)	09/07→12/10			4	3	U5055	48206
1.6, THP 156	Hbk	EP6CDT	06/10→			4	3	U5055	48206
1.6, VTi 120	Hbk	EP6	09/07→			4	3	U5055	48206
309 (86→93)									
1.1		E1	02/86→06/87		For Vehicles With Distributor	1	2	U1076	48339
1.1		E1	07/87→07/89	Oval Connector	For Vehicles With Distributor	1	4	U1007	48062
1.1		E1	07/87→07/89	Oval Connector, With Bracket	For Vehicles With Distributor	1	4	U1029	48132
1.1		HDZ(TU1M)	10/91→12/92	Oval Connector	For Vehicles With Distributor	1	4	U1007	48062
1.1		HDZ(TU1M)	10/91→12/92	Angular Connector	For Vehicles With Distributor	1	4	U1009	48066
1.3		G1A	02/86→07/89	Oval Connector, With Bracket	For Vehicles With Distributor	1	4	U1029	48132
1.3		G1A	02/86→07/89		For Vehicles With Distributor	1	2	U1076	48339
1.4		KDY(TU3M), KDZ(TU3M)	10/91→10/92	Oval Connector	For Vehicles With Distributor	1	4	U1007	48062
1.4		KDY(TU3M), KDZ(TU3M)	10/91→10/92	Angular Connector	For Vehicles With Distributor	1	4	U1009	48066
1.6			02/86→01/89	Oval Connector, With Bracket	For Vehicles With Distributor	1	4	U1029	48132
1.6			02/86→01/89		For Vehicles With Distributor	1	2	U1076	48339
1.6, Carburettor			01/89→07/89	Oval Connector, With Bracket	For Vehicles With Distributor	1	4	U1029	48132
1.6, Carburettor			01/89→07/89		For Vehicles With Distributor	1	2	U1076	48339
1.6, Injection		BDY(XU5M2Z)	12/91→12/93	Oval Connector, With Bracket	For Vehicles With Distributor	1	4	U1029	48132
1.9		D6B(XU9JA)	04/87→07/89		For Vehicles With Distributor	1	2	U1076	48339
405 (88→96)									
1.4		KDX(TU3MC)	10/92→12/93	Oval Connector	For Vehicles With Distributor	1	4	U1007	48062
1.4		KDX(TU3MC)	10/92→12/93		For Vehicles Without Distributor	1	4	U2017	48067
1.6, Carburettor		B2A(XU52C/K)	01/88→12/92	Oval Connector, With Bracket	For Vehicles With Distributor	1	4	U1029	48132
1.6, Carburettor		B2A(XU52C/K)	01/88→12/92		For Vehicles Without Distributor	1	4	U2009	48030
1.6, Catalyst		BDY(XU5M2Z), BDY(XU5M3Z), BDZ(XU5M), BFZ(XU5JP)	10/92→10/95	Oval Connector, With Bracket	For Vehicles With Distributor	1	4	U1029	48132
1.6, Catalyst		BDY(XU5M2Z), BDY(XU5M3Z), BDZ(XU5M), BFZ(XU5JP)	10/92→10/95		For Vehicles Without Distributor	1	4	U2009	48030
1.8		LFZ(XU7JP)	10/92→10/95		For Vehicles Without Distributor	1	4	U2009	48030
1.9, Carburettor		DDZ(XU9M)	07/88→12/92		Incl. Control Unit, For Vehicles With Distributor	1	5	U1032	48143
1.9, GLx4		DDZ(XU9M)	05/89→12/92		Incl. Control Unit, For Vehicles With Distributor	1	5	U1032	48143
1.9, Injection			01/88→12/92	Oval Connector	For Vehicles With Distributor	1	4	U1007	48062
1.9, Injection			01/88→12/92	Oval Connector, With Bracket	For Vehicles With Distributor	1	4	U1029	48132
1.9, Injection			01/88→12/92		For Vehicles With Distributor	1	2	U1076	48339
1.9, Injection			01/88→12/92		For Vehicles Without Distributor	1	4	U2009	48030
1.9, Injection Catalyst		D6A(XU9J2)	02/91→12/92		Incl. Control Unit, For Vehicles With Distributor	1	5	U1032	48143
1.9, Mi16		D6C(XU9J4)	10/88→11/91	Oval Connector, With Bracket	For Vehicles With Distributor	1	4	U1029	48132
1.9, Mi16 Catalyst		D6C(XU9J4)	02/91→11/91	Oval Connector, With Bracket	For Vehicles With Distributor	1	4	U1029	48132
2.0		RFX(XU10J2)	10/92→10/95		For Vehicles Without Distributor	1	4	U2009	48030

LITRE / MODEL	BODY	ENGINE TYPE	DATE	ADDITIONAL INFORMATION	FITMENT INFORMATION	NO. OF COILS	NO. OF PINS	PART NO.	STOCK NO.
PEUGEOT (continued)									
405 (88→96)									
2.0, GRx4		RFX(XU10J2)	04/93→03/94		For Vehicles Without Distributor	1	4	U2009	48030
2.0, Mi16		RFY(XU10J4Z)	12/92→10/95			4	3	U5044	48163
405 (88→97)									
1.6, Carburettor		B2A(XU52C/K)	10/88→08/92	Oval Connector, With Bracket	For Vehicles With Distributor	1	4	U1029	48132
1.6, Carburettor		B2A(XU52C/K)	10/88→08/92		For Vehicles Without Distributor	1	4	U2009	48030
1.6, Catalyst		BDY(XU5M2Z), BDY(XU5M3Z), BDZ(XU5M), BFZ(XU5JP)	10/92→12/95	Oval Connector, With Bracket	For Vehicles With Distributor	1	4	U1029	48132
1.6, Catalyst		BDY(XU5M2Z), BDY(XU5M3Z), BDZ(XU5M), BFZ(XU5JP)	10/92→12/95		For Vehicles Without Distributor	1	4	U2009	48030
1.8		LFZ(XU7JP)	10/92→10/96		For Vehicles Without Distributor	1	4	U2009	48030
1.9, Carburettor		DDZ(XU9M)	10/88→08/92		Incl. Control Unit, For Vehicles With Distributor	1	5	U1032	48143
1.9, GLx4		DDZ(XU9M)	10/91→08/92		Incl. Control Unit, For Vehicles With Distributor	1	5	U1032	48143
1.9, Injection Catalyst		DKZ(XU9JAZ)	02/91→08/92	Oval Connector	For Vehicles With Distributor	1	4	U1007	48062
1.9, Injection Catalyst		DKZ(XU9JAZ)	02/91→08/92	Oval Connector, With Bracket	For Vehicles With Distributor	1	4	U1029	48132
2.0		RFX(XU10J2)	10/92→10/96		For Vehicles Without Distributor	1	4	U2009	48030
2.0, GRx4		RFX(XU10J2)	04/93→03/94		For Vehicles Without Distributor	1	4	U2009	48030
406 (96→99)									
1.8	Est, Sal	LFY(XU7JP4)	11/95→09/97			1	4	U6040	48405
1.8	Est, Sal	LFY(XU7JP4)	09/97→03/99			1	4	U6012	48051
2.0	Cpe	RFV(XU10J4R)	10/97→12/99			1	4	U6012	48051
2.0	Cpe	RFV(XU10J4R)	03/97→10/97			1	4	U6040	48405
2.0	Est, Sal	RFV(XU10J4R)	11/95→09/97			1	4	U6040	48405
2.0	Est, Sal	RFV(XU10J4R)	09/97→03/99			1	4	U6012	48051
2.0	Sal	RFV(XU10J4R)	02/96→09/97			1	4	U6012	48051
2.0, Turbo	Est	RGX(XU10J2TE)	02/97→03/99		For Vehicles Without Distributor	1	4	U2009	48030
2.0, Turbo	Sal	RGX(XU10J2TE)	07/96→03/99		For Vehicles Without Distributor	1	4	U2009	48030
3.0	Cpe	XFZ(ES9J4)	07/97→12/99			1	4	U6016	48075
3.0	Est, Sal	XFZ(ES9J4)	01/97→12/99			1	4	U6016	48075
406 (99→04)									
1.8	Est	6FZ(EW7J4)	10/00→07/04			1	4	U6009	48032
1.8	Est, Sal	LFY(XU7JP4)	03/99→10/00			1	4	U6012	48051
1.8	Sal	6FZ(EW7J4)	10/00→05/04			1	4	U6009	48032
2.0	Cpe	RFV(XU10J4R)	12/99→09/03			1	4	U6012	48051
2.0	Est	RFN(EW10J4), RLZ(EW10D)	05/01→07/04			1	6	U6034	48282
2.0	Est	RFN(EW10J4), RLZ(EW10D)	10/00→07/04			1	4	U6009	48032
2.0	Sal	RFN(EW10J4), RLZ(EW10D)	05/01→05/04			1	6	U6034	48282
2.0	Sal	RFN(EW10J4), RLZ(EW10D)	10/00→05/04			1	4	U6009	48032
2.0	Sal	RFR(DEW10J4)	03/99→08/00			1	4	U6009	48032
2.0, HPi	Est	RLZ(EW10D)	08/01→07/04			1	6	U6034	48282
2.0, HPi	Sal	RLZ(EW10D)	08/01→05/04			1	6	U6034	48282
2.2	Cpe	3FZ(EW12J4)	03/02→09/03			1	6	U6014	48072
2.2	Est, Sal	3FZ(EW12J4)	07/00→12/01			1	6	U6014	48072
3.0	Cpe, Est, Sal	XFZ(ES9J4S)	03/00→09/03			6	2	U5008	48031
407 (04→11)									
1.7, sw 1.8	Est	6FZ(EW7J4)	05/04→03/07			1	4	U6009	48032
1.7, sw 1.8	Est		04/07→03/09			1	6	U6013	48071
1.8	Sal	6FZ(EW7J4)	05/04→03/07			1	4	U6009	48032
1.8	Sal		04/07→03/09			1	6	U6013	48071
2.0	Sal	RFJ(EW10A), RFN(EW10J4)	05/04→12/06			1	4	U6009	48032
2.0	Sal	RFJ(EW10A), RFN(EW10J4)	09/05→12/06			1	6	U6013	48071
2.0	Sal		01/07→03/09			1	6	U6013	48071
2.0, BioFlex	Sal	RFJ(EW10A)	10/08→12/11			1	6	U6013	48071
2.0, sw	Est	RFJ(EW10A), RFN(EW10J4)	05/04→12/06			1	4	U6009	48032
2.0, sw	Est	RFJ(EW10A), RFN(EW10J4)	09/05→12/06			1	6	U6013	48071
2.0, sw	Est		01/07→03/09			1	6	U6013	48071

LITRE / MODEL	BODY	ENGINE TYPE	DATE	ADDITIONAL INFORMATION	FITMENT INFORMATION	NO. OF COILS	NO. OF PINS	PART NO.	STOCK NO.
PEUGEOT (continued)									
407 (04→11)									
2.0, sw BioFlex	Est	RFJ(EW10A)	10/08→12/11			1	6	U6013	48071
2.2	Cpe	3FY(EW12J4)	11/05→03/09			1	6	U6014	48072
2.2	Cpe	3FY(EW12J4)	11/05→03/09			1	6	U6018	48077
2.2	Sal	3FY(EW12J4)	10/05→03/09			1	6	U6018	48077
2.2	Sal	3FZ(EW12J4)	05/04→09/05			1	6	U6014	48072
2.2, sw	Est	3FY(EW12J4)	10/05→03/09			1	6	U6018	48077
2.2, sw	Est	3FZ(EW12J4)	05/04→09/05			1	6	U6014	48072
2.9, sw 3.0	Est	XFV(ES9A)	05/04→12/07			6	2	U5008	48031
3.0	Cpe	XFV(ES9A)	11/05→10/08			6	2	U5008	48031
3.0	Sal	XFV(ES9A)	05/04→12/07			6	2	U5008	48031
505 (79→91)									
2.0, GL	Sal	106(XN1)	08/83→10/84		For Vehicles With Distributor	1	2	U1076	48339
2.0, GR/Family	Est	106E(XN1A)	09/85→11/87		For Vehicles With Distributor	1	2	U1076	48339
2.0, GR/SR	Sal	106(XN1), 106E(XN1A)	11/80→07/88		For Vehicles With Distributor	1	2	U1076	48339
2.0, STi	Sal	829(ZEJ)	01/80→12/83		For Vehicles With Distributor	1	2	U1076	48339
2.2, GTi	Sal		08/83→05/90		For Vehicles With Distributor	1	2	U1076	48339
508 (11→)									
1.6, sw THP 156	Est	EP6CDT	04/11→			4	3	U5055	48206
1.6, sw VTi 120	Est	5FS(EP6C)	04/11→			4	3	U5055	48206
1.6, THP 156	Sal	EP6CDT	03/11→			4	3	U5055	48206
1.6, VTi 120	Sal	5FS(EP6C)	03/11→			4	3	U5055	48206
605 (90→99)									
2.0		RFZ(XU10J2Z)	09/90→01/95	Angular Connector	For Vehicles With Distributor	1	4	U1009	48066
2.0		RFZ(XU10J2Z)	09/90→01/95		For Vehicles Without Distributor	1	4	U2009	48030
2.0	Sal	RFZ(XU10J2Z)	07/94→09/97			1	4	U6040	48405
2.0, Turbo		RGX(XU10J2TE)	03/93→01/99		For Vehicles Without Distributor	1	4	U2009	48030
607 (00→09)									
2.0		RFN(EW10J4)	04/01→03/05			1	4	U6009	48032
2.2		3FZ(EW12J4)	06/00→11/05			1	6	U6014	48072
3.0		XFV(ES9A), XFX(ES9J4S)	06/00→12/09			6	2	U5008	48031
806 (95→02)									
2.0		RFN(EW10J4)	09/00→08/02			1	4	U6012	48051
2.0		RFU(XU10J2)	10/95→05/00		For Vehicles Without Distributor	1	4	U2009	48030
807 (02→11)									
2.0		RFJ(EW10A)	11/05→12/10			1	6	U6013	48071
2.0		RFN(EW10J4)	10/02→11/05			1	4	U6009	48032
2.2		3FZ(EW12J4)	10/02→02/06			1	6	U6014	48072
1007 (05→09)									
1.4		KFU(ET3J4)	12/05→12/07			1	6	U6021	48124
1.4		TU3A	07/05→03/09			1	4	U6015	48074
1.4		TU3JP	07/05→03/09	White Connector		1	4	U6005	48016
1.6		NFU(TU5JP4)	07/05→03/09	Grey Connector		1	4	U6004	48014
3008 (09→)									
1.6, THP 150		5FX(EP6DT)	09/09→09/10			4	3	U5055	48206
1.6, THP 156		5FV(EP6DT)	01/10→			4	3	U5055	48206
1.6, VTi 120		5FS(EP6C), EP6	09/09→			4	3	U5055	48206
5008 (10→)									
1.6, THP 156		EP6CDT	01/10→			4	3	U5055	48206
1.6, VTi 120		5FS(EP6C), EP6	01/10→			4	3	U5055	48206
Bipper (08→)									
1.4	Van	KFV(TU3A), TU3AE5	05/08→03/12			1	4	U6015	48074
1.4, Tepee	MPV	KFV(TU3A)	09/09→03/12			1	4	U6015	48074
Boxer (94→02)									
2.0		RFW(XU10J2)	06/94→04/02		For Vehicles Without Distributor	1	4	U2009	48030
Boxer (02→07)									
2.0		RFL(XU10J2U)	04/02→05/06		For Vehicles Without Distributor	1	4	U2009	48030

LITRE / MODEL	BODY	ENGINE TYPE	DATE	ADDITIONAL INFORMATION	FITMENT INFORMATION	NO. OF COILS	NO. OF PINS	PART NO.	STOCK NO.
PEUGEOT (continued)									
J5/Express (85→90)									
1.8		169B(XM7T)	01/85→11/88		For Vehicles With Distributor	1	2	U1076	48339
2.0		170(XN1T)	01/85→06/90		For Vehicles With Distributor	1	2	U1076	48339
Partner (96→02)									
1.4	Van	KFX(TU3JP)	06/98→10/02	Black Connector		1	4	U6008	48023
1.4	Van	KFX(TU3JP)	10/96→05/98		For Vehicles Without Distributor	1	4	U2009	48030
1.4	Van	TU32	10/96→10/02	Angular Connector	For Vehicles With Distributor	1	4	U1009	48066
1.4, Combi	MPV	KFW(TU3JP)	06/01→10/02	White Connector		1	4	U6005	48016
1.4, Combi	MPV	KFX(TU3JP)	06/01→10/02	Black Connector		1	4	U6008	48023
1.4, Combi	MPV	TU32	06/01→10/02	Angular Connector	For Vehicles With Distributor	1	4	U1009	48066
Partner (02→11)									
1.4	Van	KFX(TU3JP)	10/02→10/08	Black Connector		1	4	U6008	48023
1.4	Van	TU32	10/02→10/08	Angular Connector	For Vehicles With Distributor	1	4	U1009	48066
1.4, Combi	MPV	KFW(TU3JP)	10/02→12/05	White Connector		1	4	U6005	48016
1.4, Combi	MPV	KFX(TU3JP)	10/02→12/05	Black Connector		1	4	U6008	48023
1.4, Combi	MPV	TU32	10/02→12/05	Angular Connector	For Vehicles With Distributor	1	4	U1009	48066
1.6, Combi	MPV	NFU(TU5JP4)	10/02→12/05	Grey Connector		1	4	U6004	48014
Partner (08→)									
1.6	Van	NFR(TU5JP4B)	06/08→03/12	Grey Connector		1	4	U6004	48014
1.6, Tepee	MPV	NFR(TU5JP4B)	06/08→03/12	Grey Connector		1	4	U6004	48014
1.6, Tepee	MPV	NFU(TU5JP4)	06/08→04/10	Grey Connector		1	4	U6004	48014
1.6, Tepee VTi 98	MPV		08/10→	Grey Connector		1	4	U6004	48014
1.6, Tepee VTi 120	MPV	5FS(EP6C)	04/10→	Grey Connector		1	4	U6004	48014
RCZ (10→)									
1.6, THP 156		EP6CDT	03/10→			4	3	U5055	48206
1.6, THP 200		EP6CDTX	06/10→			4	3	U5055	48206

PORSCHE									
911 993 (93→98)									
3.6, Turbo		M64.60	04/95→09/97			6	3	U5181	48562
911 996 (97→06)									
3.4, Carrera	Cnv	M96.01, M96.04	10/98→09/01			6	3	U5181	48562
3.4, Carrera	Cpe	M96.01, M96.04	10/97→09/01			6	3	U5181	48562
3.4, Carrera 4	Cnv	M96.02, M96.04	10/98→09/01			6	3	U5181	48562
3.4, Carrera 4	Cpe	M96.01, M96.04	10/98→09/01			6	3	U5181	48562
3.6, Carrera 2	Cnv	M96.03	10/01→07/05			6	3	U5181	48562
3.6, Carrera 2	Cpe	M96.03	10/01→12/04			6	3	U5181	48562
3.6, Carrera 4	Cnv	M96.03	10/01→12/03			6	3	U5181	48562
3.6, Carrera 4	Cpe	M96.03	10/01→12/04			6	3	U5181	48562
3.6, Carrera 4S	Cnv	M96.03	10/03→08/05			6	3	U5181	48562
3.6, Carrera 4S	Cpe	M96.03	10/01→08/05			6	3	U5181	48562
3.6, GT2	Cpe	M96.70	04/01→08/05			6	3	U5181	48562
3.6, GT3	Cpe	M96.79	10/03→08/05			6	3	U5181	48562
3.6, GT3 RS	Cpe	M96.79	10/03→12/04			6	3	U5181	48562
3.6, Targa	Cpe	M96.03	10/01→08/05			6	3	U5181	48562
3.6, Turbo	Cnv	M96.70	10/03→12/04			6	3	U5181	48562
3.6, Turbo	Cpe	M96.70	06/00→12/04			6	3	U5181	48562
3.6, Turbo S	Cnv	M96.70	09/04→08/05			6	3	U5181	48562
3.6, Turbo S	Cpe	M96.70	06/04→08/05			6	3	U5181	48562
911 997 Gen1 (04→10)									
3.6, Carrera	Cnv	M96.05	04/05→08/08			6	3	U5181	48562
3.6, Carrera	Cpe	M96.05	09/04→08/08			6	3	U5181	48562
3.6, Carrera 4	Cnv, Cpe	M96.05	10/05→12/08			6	3	U5181	48562
3.6, GT2	Cpe	M97.70S	11/07→03/10			6	3	U5181	48562
3.6, GT3	Cpe	M97.76	08/06→04/10			6	3	U5181	48562
3.6, Targa 4	Cpe	M96.05	11/06→12/08			6	3	U5181	48562
3.6, Turbo	Cnv	M97.70	09/07→05/10			6	3	U5181	48562

LITRE / MODEL	BODY	ENGINE TYPE	DATE	ADDITIONAL INFORMATION	FITMENT INFORMATION	NO. OF COILS	NO. OF PINS	PART NO.	STOCK NO.
PORSCHE (continued)									
911 997 Gen1 (04→10)									
3.6, Turbo	Cpe	M97.70	04/06→05/10			6	3	U5181	48562
3.8, Carrera 4S	Cnv, Cpe	M97.01	10/05→12/08			6	3	U5181	48562
3.8, Carrera S	Cnv	M97.01	04/05→08/08			6	3	U5181	48562
3.8, Carrera S	Cpe	M97.01	09/04→08/08			6	3	U5181	48562
3.8, Targa 4S	Cpe	M97.01	11/06→12/08			6	3	U5181	48562
911 997 Gen2 (08→)									
3.6, GT2 RS		M97.70	08/10→12/11			6	3	U5181	48562
924									
2.0		XJ, XK	04/77→07/85		For Vehicles With Distributor	1	2	U1065	48302
Boxster 986									
2.5		M96.20	10/96→08/99			6	3	U5181	48562
2.7		M96.22	08/99→06/02			6	3	U5181	48562
2.7		M96.23	07/02→12/04			6	3	U5181	48562
3.2, S		M96.21	08/99→06/02			6	3	U5181	48562
3.2, S		M96.24	07/02→12/04			6	3	U5181	48562
3.2, S Anniversary		M96.24	01/04→12/04			6	3	U5181	48562
Boxster 987									
2.7		M96.25	11/04→08/06			6	3	U5181	48562
2.7		M97.20	08/06→08/09			6	3	U5181	48562
3.2, S		M96.26	11/04→08/06			6	3	U5181	48562
3.4, RS60 Spyder		M97.21	03/08→12/08			6	3	U5181	48562
3.4, S		M97.21	08/06→08/09			6	3	U5181	48562
Cayenne 955									
3.2		M02.2Y	02/04→04/07			6	4	U5020	48065
Cayman 987									
2.7		M97.20	07/06→08/09			6	3	U5181	48562
3.4, S		M97.21	11/05→08/09			6	3	U5181	48562
3.4, S Sport		M97.22	08/08→04/09			6	3	U5181	48562

PROTON									
Compact									
1.3		4G13	07/96→01/01		For Vehicles Without Distributor	1	3	U2006	48025
Gen 2									
1.3	Hbk	S4PE	03/05→		For Vehicles Without Distributor	1	3	U2006	48025
1.6	Hbk	S4PH	09/04→		For Vehicles Without Distributor	1	3	U2006	48025
1.6	Sal	S4PH	07/08→		For Vehicles Without Distributor	1	3	U2006	48025
1.6, ecoLogic	Hbk, Sal	S4PH	07/08→		For Vehicles Without Distributor	1	3	U2006	48025
Impian									
1.6		4G18P	09/01→11/06			2	3	U4014	48225
1.6			11/06→12/08			2	3	U4014	48225
Persona (93→00)									
1.5	Hbk, Sal	4G15	01/94→01/00	With Bracket		1	2	U1022	48113
Satria Neo									
1.3		S4PE	02/07→09/08		For Vehicles Without Distributor	1	3	U2006	48025
1.6		S4PH	02/07→		For Vehicles Without Distributor	1	3	U2006	48025
Savvy									
1.2			01/06→			1	4	U6036	48007
Wira (00→04)									
1.3	Hbk, Sal	4G13	08/00→12/04		For Vehicles Without Distributor	1	3	U2006	48025
1.5	Hbk	4G15M	08/00→12/04		For Vehicles Without Distributor	1	3	U2006	48025
1.5	Sal	4G15	08/00→12/04		For Vehicles Without Distributor	1	3	U2006	48025

LITRE / MODEL	BODY	ENGINE TYPE	DATE	ADDITIONAL INFORMATION	FITMENT INFORMATION	NO. OF COILS	NO. OF PINS	PART NO.	STOCK NO.
RELIANT									
Fox									
0.8, 850			01/85→01/90		Conventional Coil Ignition (CI), With Distributor	1	2	U1056	48236
Kitten									
0.8, 850	Est, Sal		01/80→12/83		For Vehicles With Distributor	1	2	U1079	48342
Scimitar									
2.8, GTE			01/80→06/86		Electronic Ignition (EI)	1	2	U1070	48307

RENAULT									
Alpine/GTA A610									
3.0			04/92→04/95		Not Incl. Control Unit, Electronic Ignition (EI), With Distributor	1	3	U1012	48092
Alpine/GTA GTA									
2.5, Turbo		Z7U	01/88→07/90		Incl. Control Unit, For Vehicles With Distributor	1	5	U1032	48143
Avantime									
2.0, Turbo		F4R760, F4R761	06/02→05/03			4	2	U5001	48002
3.0		L7X720, L7X721	06/02→05/03			6	2	U5008	48031
Clio MK 1 (91→98)									
1.1	Hbk	C1E700	06/92→08/92		For Vehicles With Distributor	1	2	U1079	48342
1.2	Hbk	D7F730	05/96→05/98	Angular Connector		1	4	U2019	48078
1.2	Hbk	E5F710	03/91→03/96		Not Incl. Control Unit, For Vehicles With Distributor	1	3	U1012	48092
1.2	Van	E7F750	01/94→04/95		Not Incl. Control Unit, For Vehicles With Distributor	1	3	U1012	48092
1.2	Van	E7F750	01/94→04/95		Incl. Control Unit, For Vehicles With Distributor	1	5	U1032	48143
1.4	Hbk	E7J710, E7J711	03/91→05/96		Not Incl. Control Unit, For Vehicles With Distributor	1	3	U1012	48092
1.4	Hbk	E7J710, E7J711	03/91→05/96		Incl. Control Unit, For Vehicles With Distributor	1	5	U1032	48143
1.4	Hbk	E7J756, E7J757	05/96→05/98		Not Incl. Control Unit, For Vehicles With Distributor	1	3	U1012	48092
1.4	Hbk	E7J756, E7J757	05/96→05/98		Incl. Control Unit, For Vehicles With Distributor	1	5	U1032	48143
1.8	Hbk	F3P710	03/91→03/94		Not Incl. Control Unit, For Vehicles With Distributor	1	3	U1012	48092
1.8	Hbk	F3P710	03/91→03/94		Incl. Control Unit, For Vehicles With Distributor	1	5	U1032	48143
1.8	Hbk	F3P758	08/95→10/97		Not Incl. Control Unit, For Vehicles With Distributor	1	3	U1012	48092
1.8	Hbk	F3P758	08/95→10/97		Incl. Control Unit, For Vehicles With Distributor	1	5	U1032	48143
1.8	Hbk	F7P722	11/91→03/96		Not Incl. Control Unit, For Vehicles With Distributor	1	3	U1012	48092
1.8	Hbk	F7P722	11/91→03/96		Incl. Control Unit, For Vehicles With Distributor	1	5	U1032	48143
1.8, RSi	Hbk	F3P712	04/93→04/95		Not Incl. Control Unit, For Vehicles With Distributor	1	3	U1012	48092
1.8, RSi	Hbk	F3P712	04/93→04/95		Incl. Control Unit, For Vehicles With Distributor	1	5	U1032	48143
2.0	Hbk	F7R700	01/94→12/95		Not Incl. Control Unit, For Vehicles With Distributor	1	3	U1012	48092
2.0	Hbk	F7R700	01/94→12/95		Incl. Control Unit, For Vehicles With Distributor	1	5	U1032	48143
Clio MK 2 Phase 1 (98→01)									
1.2		D7F722	03/99→04/01	Oval Connector	For Vehicles Without Distributor	1	4	U2007	48026
1.2			12/00→04/01	Oval Connector	For Vehicles Without Distributor	1	4	U2007	48026
1.4		E7J634, E7J635, K7J700	09/98→04/01	Oval Connector	For Vehicles Without Distributor	1	4	U2007	48026
1.4		E7J780	09/98→04/01		For Cyl.: 1 & 4, Black Connector	1	3	U3002	48019
1.4		E7J780	09/98→04/01		For Cyl.: 2 & 3, White Connector	1	3	U3003	48020

LITRE / MODEL	BODY	ENGINE TYPE	DATE	ADDITIONAL INFORMATION	FITMENT INFORMATION	NO. OF COILS	NO. OF PINS	PART NO.	STOCK NO.
RENAULT (continued)									
Clio MK 2 Phase 1 (98→01)									
1.4		K4J710, K4J711, K4J712, K4J713	08/00→04/01			4	2	U5001	48002
1.6		K4M708, K4M740, K4M742, K4M743, K4M744, K4M745, K4M748	03/99→04/01			4	2	U5001	48002
1.6		K7M744, K7M745	09/98→01/00		For Cyl.: 1 & 4, Black Connector	1	3	U3002	48019
1.6		K7M744, K7M745	09/98→01/00		For Cyl.: 2 & 3, White Connector	1	3	U3003	48020
1.6, Alize			01/00→04/01			4	2	U5001	48002
2.0		F4R730	02/00→04/01	Angular Connector		1	4	U2019	48078
3.0		L7X760	11/00→06/01			6	2	U5008	48031
Clio MK 2 Phase 2 (01→09)									
1.1, Campus 1.2		D7F720, D7F726, D7F746, D7F764, D7F766	11/05→08/09	Oval Connector	For Vehicles Without Distributor	1	4	U2007	48026
1.1, Campus 1.2			11/05→08/09	Without ignition cable/ four-point mounting		1	4	U2028	48108
1.2		D4F712	06/01→06/04			1	4	U6036	48007
1.2		D4F722	06/04→12/05	Without ignition cable/ four-point mounting		1	4	U2028	48108
1.2		D7F720, D7F726, D7F746, D7F764, D7F766	04/01→12/05	Oval Connector	For Vehicles Without Distributor	1	4	U2007	48026
1.4		K4J710, K4J711, K4J712, K4J713	04/01→12/05			4	2	U5001	48002
1.6		K4M708, K4M740, K4M742, K4M743, K4M744, K4M745, K4M748	04/01→10/05			4	2	U5001	48002
2.0, Renaultsport 172		F4R730	04/01→12/03	Angular Connector		1	4	U2019	48078
2.0, Renaultsport 182		F4R738	01/04→12/05	Angular Connector		1	4	U2019	48078
3.0		L7X760	10/01→12/02			6	2	U5008	48031
3.0		L7X762	07/03→10/05			6	2	U5008	48031
Clio MK 3 Phase 1 (05→09)									
1.1, Sport Tourer 1.2	Est	D4F740	05/08→09/09	Without ignition cable/ four-point mounting		1	4	U2028	48108
1.1, Sport Tourer 1.2 TCe 100	Est	D4F784	04/08→09/09	Oval Connector	For Vehicles Without Distributor	1	4	U2007	48026
1.2	Hbk	D4F740, D4F764	10/05→09/09	With ignition cable/ four-point mounting		1	4	U6052	49075
1.2	Hbk	D4F740, D4F764	10/05→09/09	Without ignition cable/ four-point mounting		1	4	U2028	48108
1.2 E85 Bioethanol	Hbk	D4F740, D4F742	07/08→09/09	Without ignition cable/ four-point mounting		1	4	U2028	48108
1.2 Turbo Tce 100	Hbk	D4F784	06/07→09/09	Oval Connector	For Vehicles Without Distributor	1	4	U2007	48026
1.4	Hbk	K4J780	10/05→12/07			4	2	U5001	48002
1.6, Sport Tourer VVT	Est	K4M800, K4M801	05/08→09/09			4	2	U5001	48002
1.6, VVT	Hbk	K4M800, K4M801	10/05→09/09			4	2	U5001	48002
2.0, Renaultsport 197	Hbk	F4R830	06/06→09/09			4	2	U5001	48002
2.0, Renaultsport 197 R27	Hbk	F4R830	06/07→04/08			4	2	U5001	48002
2.0, VVT	Hbk	M4R700, M4R701	10/06→09/09			4	3	U5043	48162
Clio MK 3 Phase 2 (09→13)									
1.1, Sport Tourer 1.2	Est	D4F740	05/09→	With ignition cable/ four-point mounting		1	4	U6052	49075
1.1, Sport Tourer 1.2	Est	D4F740	05/09→	Without ignition cable/ four-point mounting		1	4	U2028	48108
1.1, Sport Tourer 1.2 TCe 100	Est	D4F784	05/09→	Oval Connector	For Vehicles Without Distributor	1	4	U2007	48026
1.2	Hbk	D4F764	05/09→	Without ignition cable/ four-point mounting		1	4	U2028	48108
1.2	Hbk	D4F764	05/09→	Without ignition cable/ four-point mounting		1	4	U2028	48108
1.2 Turbo Tce 100	Hbk	D4F784	05/09→	Oval Connector	For Vehicles Without Distributor	1	4	U2007	48026
1.6, Sport Tourer VVT 111	Est	K4M800, K4M801	05/09→			4	2	U5001	48002
1.6, VVT 111	Hbk		05/09→			4	2	U5001	48002
1.6, VVT 128	Hbk	K4M862	06/09→03/11			4	2	U5001	48002

LITRE / MODEL	BODY	ENGINE TYPE	DATE	ADDITIONAL INFORMATION	FITMENT INFORMATION	NO. OF COILS	NO. OF PINS	PART NO.	STOCK NO.
RENAULT (continued)									
Clio MK 3 Phase 2 (09→13)									
2.0, Gordini 200	Hbk	F4R830	06/10→03/12			4	2	U5001	48002
2.0, Renaultsport 200	Hbk	F4R830	05/09→			4	2	U5001	48002
Clio MK 4 (12→)									
0.9, Tce 90		H4bt400	11/12→			3	3	U5155	48410
1.2, TCe 120		H5ft403	03/13→			4	3	U5155	48410
Espace MK 1 (85→91)									
2.0, Carburettor		J6R234, J6R236	07/85→03/88		Not Incl. Control Unit, For Vehicles With Distributor	1	3	U1012	48092
2.0, Carburettor		J6R734	03/88→12/90		Not Incl. Control Unit, For Vehicles With Distributor	1	3	U1012	48092
2.0, Injection		J7R760	01/89→12/90		Not Incl. Control Unit, For Vehicles With Distributor	1	3	U1012	48092
2.0, Injection		J7R760	01/89→12/90		Incl. Control Unit, For Vehicles With Distributor	1	5	U1032	48143
2.0, Quadra		J7R760	03/89→07/91		Not Incl. Control Unit, For Vehicles With Distributor	1	3	U1012	48092
2.0, Quadra		J7R760	03/89→07/91		Incl. Control Unit, For Vehicles With Distributor	1	5	U1032	48143
Espace MK 2 (91→97)									
2.0		J7R768	06/91→10/96		Not Incl. Control Unit, For Vehicles With Distributor	1	3	U1012	48092
2.0		J7R768	06/91→10/96		Incl. Control Unit, For Vehicles With Distributor	1	5	U1032	48143
2.2		J7T772, J7T773, J7T776	09/94→03/97		Not Incl. Control Unit, For Vehicles With Distributor	1	3	U1012	48092
2.2		J7T772, J7T773, J7T776	09/94→03/97		Incl. Control Unit, For Vehicles With Distributor	1	5	U1032	48143
2.9		Z7W712, Z7W713, Z7W717	05/93→10/96		Not Incl. Control Unit, For Vehicles With Distributor	1	3	U1012	48092
2.9		Z7W712, Z7W713, Z7W717	05/93→10/96		Incl. Control Unit, For Vehicles With Distributor	1	5	U1032	48143
Espace MK 3 (97→03)									
2.0		F3R728, F3R729, F3R742, F3R768, F3R769	05/97→01/00		For Vehicles Without Distributor	2	3	U3008	48060
2.0		F4R700, F4R701	06/99→10/02			4	2	U5001	48002
3.0		L7X727	01/99→10/02			6	2	U5008	48031
3.0		Z7X775	04/97→10/98	Angular Connector	For Vehicles Without Distributor	1	3	U3005	48028
Espace MK 4 (03→12)									
2.0		F4R792	02/03→03/11			4	2	U5001	48002
2.0, T		F4R796, F4R797, F4R896, F4R897	05/05→12/06			4	2	U5001	48002
2.0, Turbo		F4R794, F4R795, F4R796, F4R797	02/03→07/05			4	2	U5001	48002
3.5		V4Y711, V4Y715	02/03→05/06			6	3	U5112	48332
Extra Phase 1 (86→91)									
1.1		C1E750, C1E752, C1E754, C1E756, C1E760, C1E762, C1E792	03/86→12/91		For Vehicles With Distributor	1	2	U1079	48342
1.4		C1J768, C1J780, C2J784, C3J700, C3J702, C3J760, C3J762	03/86→08/91		Incl. Control Unit, For Vehicles With Distributor	1	5	U1032	48143
1.4		C1J768, C1J780, C2J784, C3J700, C3J702, C3J760, C3J762	03/86→12/91		Not Incl. Control Unit, For Vehicles With Distributor	1	3	U1012	48092
1.4, Catalyst		C1J768, C1J780, C2J784, C3J700, C3J702, C3J760, C3J762	04/90→08/91		Incl. Control Unit, For Vehicles With Distributor	1	5	U1032	48143
1.4, Catalyst		C1J768, C1J780, C2J784, C3J700, C3J702, C3J760, C3J762	04/90→12/91		Not Incl. Control Unit, For Vehicles With Distributor	1	3	U1012	48092
Extra Phase 2 (92→98)									
1.2		C3G710, C3G712	01/92→12/93	Angular Connector, With Bracket		1	3	U1026	48123

LITRE / MODEL	BODY	ENGINE TYPE	DATE	ADDITIONAL INFORMATION	FITMENT INFORMATION	NO. OF COILS	NO. OF PINS	PART NO.	STOCK NO.
RENAULT (continued)									
Extra Phase 2 (92→98)									
1.4		E7J773	05/95→08/97		Incl. Control Unit, For Vehicles With Distributor	1	5	U1032	48143
Fuego									
2.0		829710, J6R710, J6R712, J6R713, J6R715, J6R726	10/80→04/84		Not Incl. Control Unit, For Vehicles With Distributor	1	3	U1012	48092
Grand Espace MK 3 (97→03)									
2.0		F4R700, F4R701	06/99→10/02			4	2	U5001	48002
3.0		L7X727	01/99→10/02			6	2	U5008	48031
Grand Espace MK 4 (03→12)									
2.0, T		F4R796, F4R797, F4R896, F4R897	05/05→12/06			4	2	U5001	48002
2.0, Turbo		F4R794, F4R795, F4R796, F4R797	02/03→07/05			4	2	U5001	48002
3.5		V4Y711, V4Y715	02/03→08/09			6	3	U5112	48332
Grand Modus (08→12)									
1.1		D4F764, D4F740	02/08→12/12			1	4	U6052	49075
1.2 Turbo Tce 100		D4F784	02/08→12/12	Oval Connector	For Vehicles Without Distributor	1	4	U2007	48026
1.6		K4M790, K4M791, K4M800, K4M801	02/08→12/12			4	2	U5001	48002
Grand Scenic MK 2 (03→09)									
1.6		K4M761, K4M782	04/04→12/09			4	2	U5001	48002
2.0		F4R770, F4R771	04/04→12/09			4	2	U5001	48002
2.0, T		F4R776	09/04→02/07			4	2	U5001	48002
Grand Scenic MK 3 (09→12)									
1.4, TCe 130		H4J700	04/09→04/12			4	2	U5094	48284
1.6, VVT 110		K4M858	04/09→05/12			4	2	U5001	48002
2.0, VVT 140		M4RF713	05/09→04/12			4	3	U5069	48241
Grand Scenic MK 3 (12→)									
1.2, TCe 115		H5ft400	01/12→			4	3	U5155	48410
1.2, TCe 130		H5ft400	01/13→			4	3	U5155	48410
1.6, VVT 110		K4M858	01/12→			4	2	U5001	48002
Kangoo MK 1 Phase 1 (98→03)									
1.2	MPV	D4F712	01/02→04/03			1	4	U6036	48007
1.2	Van	D7F710, D7F720, D7F722, D7F726, D7F744, D7F746	01/98→04/03	Oval Connector	For Vehicles Without Distributor	1	4	U2007	48026
1.2	Van	D7F710, D7F720, D7F722, D7F726, D7F744, D7F746	01/98→04/03	Angular Connector		1	4	U2019	48078
1.4	MPV	E7J634, E7J635, E7J780, K7J700, K7J701	10/99→04/03	Oval Connector	For Vehicles Without Distributor	1	4	U2007	48026
1.4	MPV	E7J634, E7J635, E7J780, K7J700, K7J701	10/99→04/03		For Cyl.: 1 & 4, Black Connector	1	3	U3002	48019
1.4	MPV	E7J634, E7J635, E7J780, K7J700, K7J701	10/99→04/03		For Cyl.: 2 & 3, White Connector	1	3	U3003	48020
1.4	Van	E7J634, E7J635, E7J780, K7J701	01/00→04/03	Oval Connector	For Vehicles Without Distributor	1	4	U2007	48026
1.4	Van	E7J634, E7J635, E7J780, K7J701	01/00→04/03		For Cyl.: 1 & 4, Black Connector	1	3	U3002	48019
1.4	Van	E7J634, E7J635, E7J780, K7J701	01/00→04/03		For Cyl.: 2 & 3, White Connector	1	3	U3003	48020
1.6, Trekka	MPV	K4M750, K4M752, K4M753	11/01→04/03			4	2	U5001	48002
Kangoo MK 1 Phase 2 (03→09)									
1.2	MPV	D4F712	04/03→10/09			1	4	U6052	49075
1.2	Van	D4F712, D4F714, D4F730	10/05→04/09	Angular Connector		1	4	U2019	48078
1.2	Van	D4F712, D4F714, D4F730	10/05→04/09			1	4	U6036	48007
1.2	Van	D7F710, D7F720, D7F722, D7F726, D7F744, D7F746	10/03→10/05	Oval Connector	For Vehicles Without Distributor	1	4	U2007	48026
1.2	Van	D7F710, D7F720, D7F722, D7F726, D7F744, D7F746	10/03→10/05	Angular Connector		1	4	U2019	48078
1.6	MPV	K4M750, K4M752, K4M753	04/03→10/09			4	2	U5001	48002
1.6	Van	K4M752	10/03→04/09			4	2	U5001	48002
1.6, Trekka	MPV	K4M750, K4M752, K4M753	04/03→10/05			4	2	U5001	48002
Kangoo MK 2 (08→)									
1.6	MPV	K4M830, K4M831	05/09→12/12			4	2	U5001	48002
1.6	MPV	K7M750	05/09→03/11	Coupling Type M4	For Vehicles Without Distributor	4	4	U2007	48026

LITRE / MODEL	BODY	ENGINE TYPE	DATE	ADDITIONAL INFORMATION	FITMENT INFORMATION	NO. OF COILS	NO. OF PINS	PART NO.	STOCK NO.
RENAULT (continued)									
Kangoo MK 2 (08→)									
1.6	Van	K4M830	09/08→			4	2	U5001	48002
1.6	Van	K7M750	09/08→03/11	Coupling Type M4	For Vehicles Without Distributor	4	4	U2007	48026
1.6, Compact	Van	K7M750	09/08→03/11	Coupling Type M4	For Vehicles Without Distributor	4	4	U2007	48026
Laguna MK 1 (94→00)									
1.6	Est, Hbk	K4M720	05/98→12/00			4	2	U5001	48002
1.8	Est	F3P674	10/95→04/97	Angular Connector	For Vehicles Without Distributor	2	3	U3005	48028
1.8	Est, Hbk	F3P674	04/97→05/98		For Vehicles Without Distributor	2	3	U3008	48060
1.8	Est, Hbk	F4P760	05/98→12/00			4	2	U5001	48002
1.8	Hbk	F3P674	06/95→04/97	Angular Connector	For Vehicles Without Distributor	2	3	U3005	48028
1.8	Hbk	F3P720, F3P724	08/95→05/98		Not Incl. Control Unit, For Vehicles With Distributor	1	3	U1012	48092
1.8	Hbk	F3P720, F3P724	08/95→05/98		Incl. Control Unit, For Vehicles With Distributor	1	5	U1032	48143
2.0	Est	F3R768	10/98→12/00		For Vehicles Without Distributor	2	3	U3008	48060
2.0	Est	N7Q700, N7Q704	08/98→12/00		For Cyl.: 2, 3, White Connector Housing	1	3	U3007	48058
2.0	Est	N7Q700, N7Q704	08/98→12/00		For Cyl.: 1, 4, Black Connector Housing	1	3	U3009	48068
2.0	Hbk	F3R768	05/97→12/00		For Vehicles Without Distributor	2	3	U3008	48060
2.0	Hbk	F3R768	06/95→04/97	Angular Connector	For Vehicles Without Distributor	2	3	U3005	48028
2.0	Hbk	N7Q700, N7Q704	06/95→12/00		For Cyl.: 2, 3, White Connector Housing	1	3	U3007	48058
2.0	Hbk	N7Q700, N7Q704	06/95→12/00		For Cyl.: 1, 4, Black Connector Housing	1	3	U3009	48068
3.0	Hbk	L7X700, L7X701	10/97→12/00			1	4	U6016	48075
3.0	Hbk	Z7X760, Z7X765	04/94→10/97	Angular Connector	For Vehicles Without Distributor	1	3	U3005	48028
Laguna MK 2 Phase 1 (00→05)									
1.6	Hbk	K4M710, K4M714	03/01→02/05			4	2	U5001	48002
1.8	Est	F4P770, F4P774	03/01→04/05			4	2	U5001	48002
1.8	Hbk	F4P770, F4P772, F4P773, F4P774	03/01→04/05			4	2	U5001	48002
1.8, Automatic	Est, Hbk	F4P770, F4P773	03/01→04/05			4	2	U5001	48002
2.0	Est	F5R700, F5R701	08/01→04/05	Angular Connector		1	4	U2019	48078
2.0	Hbk	F5R700	08/01→04/05	Angular Connector		1	4	U2019	48078
2.0	Hbk	F5R701	08/01→02/05			4	2	U5001	48002
2.0, T	Est, Hbk	F4R764, F4R765, F4R786, F4R787	01/03→04/05			4	2	U5001	48002
3.0	Est, Hbk	L7X731	03/01→04/05			6	2	U5008	48031
Laguna MK 2 Phase 2 (05→07)									
2.0	Est, Hbk	F4R712, F4R713, F4R714, F4R715	03/05→12/07			4	2	U5001	48002
2.0, GT 205	Est, Hbk	F4R886, F4R887	03/05→12/07			4	2	U5001	48002
2.0, T	Est, Hbk	F4R784, F4R786, F4R787	03/05→12/07			4	2	U5001	48002
3.0	Est, Hbk	L7X731	03/05→08/07			6	2	U5008	48031
Laguna MK 3 (07→12)									
2.0	Est, Hbk	M4R704	10/07→12/12			4	3	U5043	48162
2.0, GT Turbo	Est, Hbk	F4R800	04/08→12/09			4	2	U5001	48002
2.0, T	Cpe	F4Rt800	11/08→12/12			4	2	U5001	48002
2.0, T	Est, Hbk	F4R811	11/07→12/09			4	2	U5001	48002
3.5	Cpe	V4Y713	11/08→03/11			6	2	U5001	48002
Master MK 1 (80→98)									
2.0		J5R716, J5R728	11/89→12/90		Not Incl. Control Unit, For Vehicles With Distributor	1	3	U1012	48092
2.0		J5R716, J5R728	11/89→12/90		For Vehicles With Distributor	1	2	U1079	48342
2.2		J7T782, J7T788	09/94→12/98		Incl. Control Unit, For Vehicles With Distributor	1	5	U1032	48143
Megane MK 1 (96→03)									
1.4	Cpe	K4J714, K4J750	04/99→12/02			4	2	U5001	48002
1.4	Hbk	E7J626	04/99→11/00	Oval Connector	For Vehicles Without Distributor	1	4	U2007	48026
1.4	Hbk	E7J764	04/96→02/99		Not Incl. Control Unit, For Vehicles With Distributor	1	3	U1012	48092

LITRE / MODEL	BODY	ENGINE TYPE	DATE	ADDITIONAL INFORMATION	FITMENT INFORMATION	NO. OF COILS	NO. OF PINS	PART NO.	STOCK NO.
RENAULT (continued)									
Megane MK 1 (96→03)									
1.4	Hbk	E7J764	04/96→02/99		Incl. Control Unit, For Vehicles With Distributor	1	5	U1032	48143
1.4	Hbk	K4J714, K4J750	01/00→12/02			4	2	U5001	48002
1.4, Classic	Sal	K4J714, K4J750	04/99→12/02			4	2	U5001	48002
1.6	Cnv	K4M700, K4M701, K4M708	04/99→03/03			4	2	U5001	48002
1.6	Cnv	K7M702	06/97→06/98		For Cyl.: 1 & 4, Black Connector	1	3	U3002	48019
1.6	Cnv	K7M702	06/97→06/98		For Cyl.: 2 & 3, White Connector	1	3	U3003	48020
1.6	Cnv, Hbk	K7M703	07/98→03/99	Oval Connector	For Vehicles Without Distributor	1	4	U2007	48026
1.6	Cnv, Hbk	K7M703	07/98→03/99	Angular Connector		1	4	U2019	48078
1.6	Cpe	K4M700, K4M701, K4M708	04/99→12/02			4	2	U5001	48002
1.6	Cpe	K7M702	04/97→07/98		For Cyl.: 1 & 4, Black Connector	1	3	U3002	48019
1.6	Cpe	K7M702	04/97→07/98		For Cyl.: 2 & 3, White Connector	1	3	U3003	48020
1.6	Cpe	K7M703	08/98→03/99	Oval Connector	For Vehicles Without Distributor	1	4	U2007	48026
1.6	Cpe	K7M703	08/98→03/99	Angular Connector		1	4	U2019	48078
1.6	Cpe, Hbk	K7M702	04/96→03/97		For Cyl.: 2, 3, White Connector Housing	1	3	U3007	48058
1.6	Cpe, Hbk	K7M702	04/96→03/97		For Cyl.: 1, 4, Black Connector Housing	1	3	U3009	48068
1.6	Hbk	K4M700, K4M701, K4M704, K4M708	04/99→12/02			4	2	U5001	48002
1.6	Hbk	K7M702	04/97→06/98		For Cyl.: 1 & 4, Black Connector	1	3	U3002	48019
1.6	Hbk	K7M702	04/97→06/98		For Cyl.: 2 & 3, White Connector	1	3	U3003	48020
1.6, Classic	Sal	K4M700, K4M701, K4M708	04/99→12/02			4	2	U5001	48002
1.6, Classic	Sal	K7M702	04/97→06/98		For Cyl.: 1 & 4, Black Connector	1	3	U3002	48019
1.6, Classic	Sal	K7M702	04/97→06/98		For Cyl.: 2 & 3, White Connector	1	3	U3003	48020
1.6, Classic	Sal	K7M702	12/96→03/97		For Cyl.: 2, 3, White Connector Housing	1	3	U3007	48058
1.6, Classic	Sal	K7M702	12/96→03/97		For Cyl.: 1, 4, Black Connector Housing	1	3	U3009	48068
1.6, Classic	Sal	K7M703	07/98→03/99	Oval Connector	For Vehicles Without Distributor	1	4	U2007	48026
1.6, Classic	Sal	K7M703	07/98→03/99	Angular Connector		1	4	U2019	48078
1.6, Scenic	MPV	K7M702, K7M703	05/97→07/98		For Cyl.: 1 & 4, Black Connector	1	3	U3002	48019
1.6, Scenic	MPV	K7M702, K7M703	05/97→07/98		For Cyl.: 2 & 3, White Connector	1	3	U3003	48020
1.6, Scenic	MPV	K7M702, K7M703	08/98→07/99	Oval Connector	For Vehicles Without Distributor	1	4	U2007	48026
1.8	Hbk	F4P720, F4P722	07/00→12/02			4	2	U5001	48002
1.8, Classic	Sal	F4P720, F4P722	07/00→12/02			4	2	U5001	48002
2.0	Cnv	F7R710, F7R714	06/97→04/99	Angular Connector		1	4	U2019	48078
2.0	Cnv, Cpe	F5R740	10/00→12/02	Angular Connector		1	4	U2019	48078
2.0	Cnv, Cpe	F5R740	11/99→09/00	Oval Connector	For Vehicles Without Distributor	1	4	U2007	48026
2.0	Cpe	F7R710, F7R714	07/96→04/99	Angular Connector		1	4	U2019	48078
2.0	Cpe, Hbk	F3R750, F3R751	04/97→04/99		For Vehicles Without Distributor	2	3	U3008	48060
2.0	Cpe, Hbk	F3R750, F3R751	07/96→03/97	Angular Connector	For Vehicles Without Distributor	2	3	U3005	48028
2.0, Classic	Sal	F3R750, F3R751, F3R752, F3R791, F3R796, F3R797, F3R798	04/97→04/99		For Vehicles Without Distributor	2	3	U3008	48060
2.0, Classic	Sal	F3R750, F3R751, F3R752, F3R791, F3R796, F3R797, F3R798	12/96→03/97	Angular Connector	For Vehicles Without Distributor	2	3	U3005	48028
2.0, Roadster	Cnv	F7R710, F7R714	06/97→04/99	Angular Connector		1	4	U2019	48078
2.0, Scenic	MPV	F3R750, F3R751	11/97→07/99		For Vehicles Without Distributor	2	3	U3008	48060
Megane MK 2 (02→09)									
1.4	Est, Sal	K4J730, K4J740	11/03→06/09			4	2	U5001	48002
1.4	Hbk	K4J730, K4J740	11/02→06/09			4	2	U5001	48002
1.6	Est, Sal	K4M760, K4M761	11/03→09/05			4	2	U5001	48002
1.6	Est, Sal	K4M760, K4M761, K4M812, K4M813, K4MD812	09/05→06/09			4	2	U5001	48002
1.6	Hbk	K4M760	11/02→09/05			4	2	U5001	48002
1.6	Hbk	K4M760, K4M812, K4M813	01/06→06/09			4	2	U5001	48002
1.6, CC	Cnv	K4M760, K4M761	11/03→09/05			4	2	U5001	48002
1.6, CC	Cnv	K4M760, K4M761, K4M812, K4M813, K4MC813, K4MD812	09/05→06/09			4	2	U5001	48002

LITRE / MODEL	BODY	ENGINE TYPE	DATE	ADDITIONAL INFORMATION	FITMENT INFORMATION	NO. OF COILS	NO. OF PINS	PART NO.	STOCK NO.
RENAULT (continued)									
Megane MK 2 (02→09)									
2.0	Cnv	F4R770, F4R771	11/03→06/09			4	2	U5001	48002
2.0	Est, Sal	F4R770, F4R771	11/03→06/09			4	2	U5001	48002
2.0	Hbk	F4R770	11/02→06/09			4	2	U5001	48002
2.0, CC T	Cnv	F4R776	09/04→06/09			4	2	U5001	48002
2.0, Renaultsport	Hbk	F4R774, F4Rt774	05/04→06/09			4	2	U5001	48002
2.0, Renaultsport 230 R26	Hbk	F4R774	12/06→12/07			4	2	U5001	48002
2.0, Renaultsport R26R	Hbk	F4R774	07/08→04/09			4	2	U5001	48002
2.0, T	Hbk	F4R776	11/04→06/09			4	2	U5001	48002
Megane MK 3 (08→12)									
1.4, TCe 130	Cnv	H4J700	06/10→08/12			4	2	U5094	48284
1.4, TCe 130	Cpe, Hbk	H4J700	11/09→06/12			4	2	U5094	48284
1.4, TCe 130	Est	H4J700	08/09→06/12			4	2	U5094	48284
1.6	Est	K4M848	08/09→08/12			4	2	U5001	48002
1.6	Hbk	K4M848	11/08→08/12			4	2	U5001	48002
1.6, VVT	Cnv	K4M858	06/10→08/12			4	2	U5001	48002
1.6, VVT	Cpe, Hbk	K4M858	11/08→08/12			4	2	U5001	48002
1.6, VVT	Est	K4M858	08/09→08/12			4	2	U5001	48002
2.0	Est	M4R711, M4RF713	08/09→06/12			4	3	U5069	48241
2.0	Hbk	M4R711	11/09→06/12			4	3	U5069	48241
2.0, Renaultsport 250	Cpe	F4R874	10/09→08/12			4	2	U5001	48002
2.0, Renaultsport 265 Trophy	Cpe	F4R874	05/11→03/12			4	2	U5001	48002
2.0, TCe 180	Cnv	F4R870, F4R872	06/10→08/12			4	2	U5001	48002
2.0, TCe 180	Cpe, Hbk	F4R870	11/08→06/12			4	2	U5001	48002
2.0, TCe 180	Est	F4R870, F4R872	08/09→06/12			4	2	U5001	48002
Megane MK 3 (12→)									
1.2, TCe 115	Cpe, Est, Hbk	H5ft400	01/12→			4	3	U5155	48410
1.2, TCe 115 sTop-start	Cpe, Est, Hbk	H5ft404	01/12→			4	3	U5155	48410
1.2, TCe 130	Cpe, Est, Hbk	H5ft400	01/12→			4	3	U5155	48410
1.2, TCe 130	Cpe, Est, Hbk	H5ft400, H5ft404	01/13→			4	3	U5155	48410
1.4, TCe 130	Cnv	H4J700	11/12→			4	2	U5094	48284
1.6, VVT	Cpe, Est, Hbk	K4M858	01/12→			4	2	U5001	48002
2.0, Renaultsport 250	Cpe	F4R874	01/12→			4	2	U5001	48002
2.0, Renaultsport 265	Cpe	F4R874	01/12→			4	2	U5001	48002
Modus (04→08)									
1.2		D4F740	12/04→06/08	With ignition cable/ four-point mounting		1	4	U6052	49075
1.2		D4F740	12/04→06/08	Without ignition cable/ four-point mounting		1	4	U2028	48108
1.4		K4J770	12/04→04/08			4	2	U5001	48002
1.6		K4M790, K4M791, K4M800, K4M801	12/04→06/08			4	2	U5001	48002
Modus (08→12)									
1.2		D4F740	02/08→12/12	Without ignition cable/ four-point mounting		1	4	U2028	48108
1.2 Turbo Tce 100		D4F784	02/08→12/12	Oval Connector	For Vehicles Without Distributor	1	4	U2007	48026
1.6		K4M790, K4M791, K4M800, K4M801	02/08→12/12			4	2	U5001	48002
R4									
0.8, 850		80001	01/80→12/82			1	2	U1062	48299
0.8, 850		80001	01/80→12/82		For Vehicles With Distributor	1	2	U1079	48342
1.1		688712	01/80→03/84		For Vehicles With Distributor	1	2	U1079	48342
R5									
1.0	Hbk	C1C700	02/85→08/87		For Vehicles With Distributor	1	2	U1079	48342
1.1	Hbk	C1E750, C1E752, C1E754	07/87→10/88		For Vehicles With Distributor	1	2	U1079	48342

LITRE / MODEL	BODY	ENGINE TYPE	DATE	ADDITIONAL INFORMATION	FITMENT INFORMATION	NO. OF COILS	NO. OF PINS	PART NO.	STOCK NO.
RENAULT (continued)									
R5									
1.1	Hbk	C1E750, C1E752, C1E754	10/89→08/90		For Vehicles With Distributor	1	2	U1079	48342
1.1	Hbk	C1E750, C1E752, C1E756, C1E760	01/86→07/87		For Vehicles With Distributor	1	2	U1079	48342
1.1	Van	C1E750, C1E752, C1E754	09/86→12/87		For Vehicles With Distributor	1	2	U1079	48342
1.2	Hbk	C1G702, C1G720, C1G722	07/87→08/90		Not Incl. Control Unit, For Vehicles With Distributor	1	3	U1012	48092
1.2	Hbk	C1G702, C1G720, C1G722	07/87→08/90		Incl. Control Unit, For Vehicles With Distributor	1	5	U1032	48143
1.2	Van	C1G702	06/87→12/89		Not Incl. Control Unit, For Vehicles With Distributor	1	3	U1012	48092
1.2	Van	C1G702	06/87→12/89		Incl. Control Unit, For Vehicles With Distributor	1	5	U1032	48143
1.4	Hbk	C1J768, C1J780	02/85→07/87		Not Incl. Control Unit, For Vehicles With Distributor	1	3	U1012	48092
1.4	Hbk	C1J768, C1J780	02/85→07/87		Incl. Control Unit, For Vehicles With Distributor	1	5	U1032	48143
1.4	Hbk	C2J700, C2J780, C2J781, C2J788, C2J789, C2J798	07/87→07/89		Not Incl. Control Unit, For Vehicles With Distributor	1	3	U1012	48092
1.4	Hbk	C2J700, C2J780, C2J781, C2J788, C2J789, C2J798	07/87→07/89		Incl. Control Unit, For Vehicles With Distributor	1	5	U1032	48143
1.4, Campus	Hbk		10/90→03/96		Not Incl. Control Unit, For Vehicles With Distributor	1	3	U1012	48092
1.4, Campus	Hbk		10/90→03/96		Incl. Control Unit, For Vehicles With Distributor	1	5	U1032	48143
1.4, Gordini	Hbk		01/82→04/82		Not Incl. Control Unit, For Vehicles With Distributor	1	3	U1012	48092
1.4, Gordini	Hbk		01/82→04/82		Incl. Control Unit, For Vehicles With Distributor	1	5	U1032	48143
1.4, GT Turbo	Hbk	C1J782, C1J784, C1J788	02/86→08/90		Not Incl. Control Unit, For Vehicles With Distributor	1	3	U1012	48092
1.4, GT Turbo	Hbk	C1J782, C1J784, C1J788	02/86→08/90		Incl. Control Unit, For Vehicles With Distributor	1	5	U1032	48143
1.7	Hbk	F2N740	09/88→09/90		Not Incl. Control Unit, For Vehicles With Distributor	1	3	U1012	48092
1.7	Hbk	F2N740	09/88→09/90		Incl. Control Unit, For Vehicles With Distributor	1	5	U1032	48143
R9									
1.2		C1G700, C1G710	10/85→12/88		Not Incl. Control Unit, For Vehicles With Distributor	1	3	U1012	48092
1.4, Automatic		C2J718, C2J757	03/82→12/85		Not Incl. Control Unit, For Vehicles With Distributor	1	3	U1012	48092
1.4, Single choke carburettor		C1J715, C1J792, C1J796, C2J730	03/82→01/88		Not Incl. Control Unit, For Vehicles With Distributor	1	3	U1012	48092
1.4, Turbo		C1J760, C1J764	12/86→01/88		Not Incl. Control Unit, For Vehicles With Distributor	1	3	U1012	48092
1.4, Twin choke carburettor		C2J717, C2J755	03/82→12/83		Not Incl. Control Unit, For Vehicles With Distributor	1	3	U1012	48092
1.7		F2N700, F2N704	04/87→12/88		Not Incl. Control Unit, For Vehicles With Distributor	1	3	U1012	48092
1.7		F2N700, F2N704	09/84→10/85		Not Incl. Control Unit, For Vehicles With Distributor	1	3	U1012	48092
R11									
1.1		C1E715, C1E720	06/83→10/85		For Vehicles With Distributor	1	2	U1079	48342
1.2		C1G700, C1G710	10/85→12/88		Not Incl. Control Unit, For Vehicles With Distributor	1	3	U1012	48092
1.4, Automatic		C2J718, C2J720, C2J757, C2J766, C2J767, C2J768	06/83→12/88		Not Incl. Control Unit, For Vehicles With Distributor	1	3	U1012	48092
1.4, Single choke carburettor		C1J715, C2J730	06/83→12/88		Not Incl. Control Unit, For Vehicles With Distributor	1	3	U1012	48092
1.4, Turbo		C1J760, C1J764	04/84→10/86		Not Incl. Control Unit, For Vehicles With Distributor	1	3	U1012	48092
1.4, Turbo		C1J770, C1J782	10/86→12/88		Not Incl. Control Unit, For Vehicles With Distributor	1	3	U1012	48092
1.4, Twin choke carburettor		C2J717, C2J755	06/83→09/84		Not Incl. Control Unit, For Vehicles With Distributor	1	3	U1012	48092

LITRE / MODEL	BODY	ENGINE TYPE	DATE	ADDITIONAL INFORMATION	FITMENT INFORMATION	NO. OF COILS	NO. OF PINS	PART NO.	STOCK NO.
RENAULT (continued)									
R11									
1.7		F2N700, F2N704, F2N732, F2N742	10/83→12/88		Not Incl. Control Unit, For Vehicles With Distributor	1	3	U1012	48092
1.7		F2N708, F2N710, F2N798, F3N708	01/88→12/88		Not Incl. Control Unit, For Vehicles With Distributor	1	3	U1012	48092
R18									
1.6, Turbo	Sal	807727	01/81→09/82		Not Incl. Control Unit, For Vehicles With Distributor	1	3	U1012	48092
1.6, Turbo	Sal	A5L717, A5L718	10/82→07/85		Not Incl. Control Unit, For Vehicles With Distributor	1	3	U1012	48092
2.0	Est	J6R716	11/81→04/84		Not Incl. Control Unit, For Vehicles With Distributor	1	3	U1012	48092
2.0	Sal	J6R716	05/82→04/84		Not Incl. Control Unit, For Vehicles With Distributor	1	3	U1012	48092
R19									
1.4	Hbk	C2J772, C3J710	02/89→04/92		Not Incl. Control Unit, For Vehicles With Distributor	1	3	U1012	48092
1.4	Hbk	C2J772, C3J710	02/89→04/92		Incl. Control Unit, For Vehicles With Distributor	1	5	U1032	48143
1.4, Carburettor	Hbk	E6J700, E6J701	02/89→07/92		Not Incl. Control Unit, For Vehicles With Distributor	1	3	U1012	48092
1.4, Carburettor	Hbk	E6J700, E6J701	02/89→07/92		Incl. Control Unit, For Vehicles With Distributor	1	5	U1032	48143
1.4, Injection	Hbk	E6J700, E7J706	01/92→12/95		Not Incl. Control Unit, For Vehicles With Distributor	1	3	U1012	48092
1.4, Injection	Hbk	E6J700, E7J706	01/92→12/95		Incl. Control Unit, For Vehicles With Distributor	1	5	U1032	48143
1.7	Hbk	F3N742, F3N743	02/89→12/91		Not Incl. Control Unit, For Vehicles With Distributor	1	3	U1012	48092
1.7	Hbk	F3N742, F3N743	02/89→12/91		Incl. Control Unit, For Vehicles With Distributor	1	5	U1032	48143
1.7	Sal	F2N720, F2N721	02/89→12/91		Not Incl. Control Unit, For Vehicles With Distributor	1	3	U1012	48092
1.7	Sal	F2N720, F2N721	02/89→12/91		Incl. Control Unit, For Vehicles With Distributor	1	5	U1032	48143
1.8	Cnv	F7P704	05/92→01/95		Not Incl. Control Unit, For Vehicles With Distributor	1	3	U1012	48092
1.8	Cnv	F7P704	05/92→01/95		Incl. Control Unit, For Vehicles With Distributor	1	5	U1032	48143
1.8	Hbk	F7P704	04/92→09/95		Not Incl. Control Unit, For Vehicles With Distributor	1	3	U1012	48092
1.8	Hbk	F7P704	04/92→09/95		Incl. Control Unit, For Vehicles With Distributor	1	5	U1032	48143
1.8	Hbk, Sal	F3P700	05/92→05/94		Not Incl. Control Unit, For Vehicles With Distributor	1	3	U1012	48092
1.8	Hbk, Sal	F3P700	05/92→05/94		Incl. Control Unit, For Vehicles With Distributor	1	5	U1032	48143
1.8	Hbk, Sal	F7P704	03/91→04/92		Not Incl. Control Unit, For Vehicles With Distributor	1	3	U1012	48092
1.8	Hbk, Sal	F7P704	03/91→04/92		Incl. Control Unit, For Vehicles With Distributor	1	5	U1032	48143
1.8	Sal	F3P700	05/92→05/94	Angular Connector, With Bracket		1	3	U1026	48123
1.8	Sal	F7P704	04/92→09/94		Not Incl. Control Unit, For Vehicles With Distributor	1	3	U1012	48092
1.8	Sal	F7P704	04/92→09/94		Incl. Control Unit, For Vehicles With Distributor	1	5	U1032	48143
1.8, RSi Execitive	Cnv	F3P682, F3P764, F3P765	04/95→04/96		Not Incl. Control Unit, For Vehicles With Distributor	1	3	U1012	48092
1.8, RSi Execitive	Cnv	F3P682, F3P764, F3P765	04/95→04/96	Angular Connector, With Bracket		1	3	U1026	48123
1.8, RSi Execitive	Cnv	F3P682, F3P764, F3P765	04/95→04/96		Incl. Control Unit, For Vehicles With Distributor	1	5	U1032	48143
R21									
1.7	Hbk, Sal	F3N722, F3N723	09/89→12/92		Not Incl. Control Unit, For Vehicles With Distributor	1	3	U1012	48092

LITRE / MODEL	BODY	ENGINE TYPE	DATE	ADDITIONAL INFORMATION	FITMENT INFORMATION	NO. OF COILS	NO. OF PINS	PART NO.	STOCK NO.
RENAULT (continued)									
R21									
1.7	Hbk, Sal	F3N722, F3N723	09/89→12/92		Incl. Control Unit, For Vehicles With Distributor	1	5	U1032	48143
1.7, TL	Sal	F2N712, F2N750, F3N726	06/86→10/90		Not Incl. Control Unit, For Vehicles With Distributor	1	3	U1012	48092
1.7, TL	Sal	F2N712, F2N750, F3N726	06/86→10/90		Incl. Control Unit, For Vehicles With Distributor	1	5	U1032	48143
2.0	Hbk	J7R746, J7R747	09/89→12/93		Not Incl. Control Unit, For Vehicles With Distributor	1	3	U1012	48092
2.0	Hbk	J7R746, J7R747	09/89→12/93		Incl. Control Unit, For Vehicles With Distributor	1	5	U1032	48143
2.0	Sal	J7R746, J7R747	07/87→12/92		Not Incl. Control Unit, For Vehicles With Distributor	1	3	U1012	48092
2.0	Sal	J7R746, J7R747	07/87→12/92		Incl. Control Unit, For Vehicles With Distributor	1	5	U1032	48143
2.0, Turbo	Sal	J7R752	05/88→03/90	Angular Connector	For Vehicles Without Distributor	1	3	U3005	48028
2.0, Turbo Quadra	Sal	J7R752	07/90→12/92		Incl. Control Unit, For Vehicles With Distributor	1	5	U1032	48143
2.0, Turbo Quadra	Sal	J7R752	07/90→12/92	Angular Connector	For Vehicles Without Distributor	1	3	U3005	48028
2.0, TXi	Hbk	J7R740, J7R754	09/89→01/91		Not Incl. Control Unit, For Vehicles With Distributor	1	3	U1012	48092
2.0, TXi	Hbk	J7R740, J7R754	09/89→01/91		Incl. Control Unit, For Vehicles With Distributor	1	5	U1032	48143
R21 Savanna									
1.7		F2N710, F2N752, F3N722, F3N723	10/86→12/92		Not Incl. Control Unit, For Vehicles With Distributor	1	3	U1012	48092
1.7		F2N710, F2N752, F3N722, F3N723	10/86→12/92		Incl. Control Unit, For Vehicles With Distributor	1	5	U1032	48143
1.7, TL		F2N712	10/86→08/88		Not Incl. Control Unit, For Vehicles With Distributor	1	3	U1012	48092
1.7, TL		F2N712	10/86→08/88		Incl. Control Unit, For Vehicles With Distributor	1	5	U1032	48143
2.0		J7R746, J7R747	10/86→12/93		Not Incl. Control Unit, For Vehicles With Distributor	1	3	U1012	48092
2.0		J7R746, J7R747	10/86→12/93		Incl. Control Unit, For Vehicles With Distributor	1	5	U1032	48143
2.0, Quadra		J7R746, J7R747	05/90→12/91		Not Incl. Control Unit, For Vehicles With Distributor	1	3	U1012	48092
2.0, Quadra		J7R746, J7R747	05/90→12/91		Incl. Control Unit, For Vehicles With Distributor	1	5	U1032	48143
R25									
2.0, Carburettor		J6R706, J6R707, J6R760, J6R762, J6R763	07/84→07/92		Not Incl. Control Unit, For Vehicles With Distributor	1	3	U1012	48092
2.0, Injection		J7R722, J7R723	07/87→12/92		Incl. Control Unit, For Vehicles With Distributor	1	5	U1032	48143
2.0, TXi		J7R720, J7R721	07/89→12/92		Not Incl. Control Unit, For Vehicles With Distributor	1	3	U1012	48092
2.0, TXi		J7R720, J7R721	07/89→12/92		Incl. Control Unit, For Vehicles With Distributor	1	5	U1032	48143
2.2		J7T730, J7T731	07/84→12/89		Not Incl. Control Unit, For Vehicles With Distributor	1	3	U1012	48092
2.2		J7T730, J7T731	07/84→12/89		Incl. Control Unit, For Vehicles With Distributor	1	5	U1032	48143
2.5, Turbo		Z7U702	07/85→05/90		Incl. Control Unit, For Vehicles With Distributor	1	5	U1032	48143
2.9		Z7W700	07/89→02/90		Incl. Control Unit, For Vehicles With Distributor	1	5	U1032	48143
2.9		Z7W706, Z7W707, Z7W709	05/90→07/92		Incl. Control Unit, For Vehicles With Distributor	1	5	U1032	48143
Safrane									
2.0		J7R732, J7R733	03/94→07/96		Not Incl. Control Unit, For Vehicles With Distributor	1	3	U1012	48092
2.0		J7R732, J7R733	03/94→07/96		Incl. Control Unit, For Vehicles With Distributor	1	5	U1032	48143

LITRE / MODEL	BODY	ENGINE TYPE	DATE	ADDITIONAL INFORMATION	FITMENT INFORMATION	NO. OF COILS	NO. OF PINS	PART NO.	STOCK NO.
RENAULT (continued)									
Safrane									
2.0		J7R734, J7R735	11/92→03/94		Not Incl. Control Unit, For Vehicles With Distributor	1	3	U1012	48092
2.0		J7R734, J7R735	11/92→03/94		Incl. Control Unit, For Vehicles With Distributor	1	5	U1032	48143
2.0		N7Q710, N7Q711	10/96→10/98		Incl. Control Unit, For Vehicles With Distributor	1	5	U1032	48143
2.0		N7Q710, N7Q711	10/96→10/98		For Cyl.: 2, 3, White Connector Housing	1	3	U3007	48058
2.2		J7T760, J7T761	03/94→07/96		Not Incl. Control Unit, For Vehicles With Distributor	1	3	U1012	48092
2.2		J7T760, J7T761	03/94→07/96		Incl. Control Unit, For Vehicles With Distributor	1	5	U1032	48143
2.5		N7U700, N7U701	10/96→10/98		Incl. Control Unit, For Vehicles With Distributor	1	4	U1035	48156
Scenic MK 1 (99→03)									
1.4		K4J714, K4J750	09/99→07/03			4	2	U5001	48002
1.8		F4P720, F4P722	07/00→07/03			4	2	U5001	48002
2.0		F4R740, F4R741, F4R744	09/99→07/03	Angular Connector		1	4	U2019	48078
2.0		F4R740, F4R741, F4R744	09/99→07/03			4	2	U5001	48002
2.0, RX4		F4R744, F4R746	06/00→03/03	Angular Connector		1	4	U2019	48078
2.0, RX4		F4R744, F4R746	06/00→03/03			4	2	U5001	48002
Scenic MK 2 (03→09)									
1.4		K4J730, K4J740	08/03→12/09			4	2	U5001	48002
1.6		K4M761, K4M782	08/03→12/05			4	2	U5001	48002
1.6		K4M761, K4M782, K4M812, K4M9766, K4MC813	09/05→12/09			4	2	U5001	48002
2.0		F4R770, F4R771	08/03→12/09			4	2	U5001	48002
2.0, T		F4R776	09/04→02/07			4	2	U5001	48002
Scenic MK 3 (09→12)									
1.4, TCe 130		H4J700	06/09→04/12			4	2	U5094	48284
1.6, VVT 110		K4M858	06/09→05/12			4	2	U5001	48002
2.0, VVT 140		M4RF713	06/09→04/12			4	3	U5069	48241
Scenic MK 3 (12→)									
1.2, TCe 115		H5ft400	01/12→			4	3	U5155	48410
1.2, TCe 130		H5ft400	01/13→			4	3	U5155	48410
1.6, VVT 110		K4M858	01/12→			4	2	U5001	48002
Trafic MK 1 (81→00)									
1.4		847700, 847701, C1J700	01/85→06/91		For Vehicles With Distributor	1	2	U1079	48342
1.6		A1M707, A1M708	01/85→06/86		For Vehicles With Distributor	1	2	U1079	48342
1.7		F1N720, F1N724	06/86→04/89		Not Incl. Control Unit, For Vehicles With Distributor	1	3	U1012	48092
1.7		F1N720, F1N724	08/92→08/94		Not Incl. Control Unit, For Vehicles With Distributor	1	3	U1012	48092
2.0		J5R716, J5R722, J5R726	06/86→04/89		Not Incl. Control Unit, For Vehicles With Distributor	1	3	U1012	48092
2.0		J5R726	05/89→12/94		Not Incl. Control Unit, For Vehicles With Distributor	1	3	U1012	48092
2.2		J7T600	09/94→10/97		Incl. Control Unit, For Vehicles With Distributor	1	5	U1032	48143
Trafic MK 2 X83 (01→10)									
2.0		F4R720, F4R722	05/01→12/08			4	2	U5001	48002
Twingo (07→12)									
1.2		D4F772	09/07→05/12	With ignition cable/ four-point mounting		1	4	U6052	49075
1.2		D4F722, D4F772	09/07→05/12	Without ignition cable/ four-point mounting		1	4	U2028	48108
1.2		D7F800	01/08→03/11	Oval Connector	For Vehicles Without Distributor	1	4	U2007	48026
1.2 Turbo Tce 100		D4F780, D4F782	09/07→05/12	Oval Connector	For Vehicles Without Distributor	1	4	U2007	48026
1.6, Gordini 133		K4M854	04/10→05/12			4	2	U5001	48002
1.6, Renaultsport 133		K4M854	10/08→05/12			4	2	U5001	48002

LITRE / MODEL	BODY	ENGINE TYPE	DATE	ADDITIONAL INFORMATION	FITMENT INFORMATION	NO. OF COILS	NO. OF PINS	PART NO.	STOCK NO.
RENAULT (continued)									
Twingo (12→)									
1.2		D4F722, D4F772	01/12→	Without ignition cable/ four-point mounting		1	4	U2028	48108
1.6, Renaultsport 133		K4M854	01/12→			4	2	U5001	48002
Vel Satis (02→06)									
2.0		F4R762, F4R763, F4R766, F4R767	06/02→08/05			4	2	U5001	48002
3.5		V4Y701, V4Y711	06/02→08/05			6	3	U5112	48332

ROLLS ROYCE									
Phantom									
6.7	Cpe	N73B68A	09/08→03/13	Triangular Connector		12	3	U5055	48026
6.7	Sal		01/03→03/13	Triangular Connector		12	3	U5055	48026
6.7, Drophead Coupe	Cnv	N73B68A	05/07→03/13	Triangular Connector		12	3	U5055	48026
6.7, EWB (Extended Wheelbase)	Sal		07/06→03/13	Triangular Connector		12	3	U5055	48026
Silver Seraph									
5.4		M73B54	03/98→09/02			12	3	U5005	48009
Silver Shadow Series 2									
6.8			01/80→12/80		For Vehicles With Distributor	1	2	U1056	48236
6.8			01/80→12/80		For Vehicles With Distributor	1	2	U1076	48339

ROVER									
25 (99→05)									
1.1		11K4F	01/04→12/07		For Vehicles Without Distributor, Black Boot, VVT Eng	2	2	U4001	48055
1.1			11/99→10/00		For Vehicles Without Distributor, Black Boot, VVT Eng	2	2	U4001	48055
1.4		14K4F	11/99→12/07	With Bracket, To Ch. No.: YD471564	For Vehicles With Distributor	1	2	U1006	48059
1.4		14K4F	11/99→12/07	From Ch. No.: YD471565	For Vehicles Without Distributor, Black Boot, VVT Eng	2	2	U4001	48055
1.4		14K4M	11/99→12/07	With Bracket, To Ch. No.: YD471564	For Vehicles With Distributor	1	2	U1006	48059
1.4		14K4M	11/99→12/07	From Ch. No.: YD471565	For Vehicles Without Distributor, Black Boot, VVT Eng	2	2	U4001	48055
1.4, Streetwise		14K4F	08/03→05/05		For Vehicles Without Distributor, Black Boot, VVT Eng	2	2	U4001	48055
1.4, Streetwise		14K4M	08/03→05/05		For Vehicles Without Distributor, Black Boot, VVT Eng	2	2	U4001	48055
1.6		16K4F	11/99→12/07	With Bracket, To Ch. No.: YD471564	For Vehicles With Distributor	1	2	U1006	48059
1.6		16K4F	11/99→12/07	From Ch. No.: YD471565	For Vehicles Without Distributor, Black Boot, VVT Eng	2	2	U4001	48055
1.6, Streetwise		16K4F	01/04→12/07	With Bracket, YD471564 To Ch. No.:	For Vehicles With Distributor	1	2	U1006	48059
1.6, Streetwise		16K4F	01/04→12/07	From Ch. No.: YD471565	For Vehicles Without Distributor, Black Boot, VVT Eng	2	2	U4001	48055
1.8		18K4F	11/99→05/01	With Bracket, To Ch. No.: YD471564	Without Variable Valve Timing, With Distributor	1	2	U1006	48059
1.8		18K4F	11/99→05/01	From Ch. No.: YD471565	Without Variable Valve Timing, Without Distributor, Black Boot, VVT Eng	2	2	U4001	48055
1.8		18K4F	11/99→05/01	From Ch. No.: YD471565	With Variable Valve Timing, Red Boot, Non VVT Eng	2	2	U4002	48100
1.8, GTi		18K4K	02/00→12/01		With Variable Valve Timing, Red Boot, Non VVT Eng	2	2	U4002	48100
1.8, Streetwise		18K4F	01/04→05/05		For Vehicles Without Distributor, Black Boot, VVT Eng	2	2	U4001	48055
45 (99→04)									
1.4	Hbk	14K4F	02/00→05/04	With Bracket, To Ch. No.: YD471564	For Vehicles With Distributor	1	2	U1006	48059

LITRE / MODEL	BODY	ENGINE TYPE	DATE	ADDITIONAL INFORMATION	FITMENT INFORMATION	NO. OF COILS	NO. OF PINS	PART NO.	STOCK NO.
ROVER (continued)									
45 (99→04)									
1.4	Hbk	14K4F	02/00→05/04	From Ch. No.: YD471565	For Vehicles Without Distributor, Black Boot, VVT Eng	2	2	U4001	48055
1.4	Hbk	14K4F	05/04→05/05	With Bracket, To Ch. No.: YD471564	For Vehicles With Distributor	1	2	U1006	48059
1.4	Hbk	14K4F	05/04→05/05	From Ch. No.: YD471565	For Vehicles Without Distributor, Black Boot, VVT Eng	2	2	U4001	48055
1.6	Hbk, Sal	16K4F	02/00→05/04	With Bracket, To Ch. No.: YD471564	For Vehicles With Distributor	1	2	U1006	48059
1.6	Hbk, Sal	16K4F	02/00→05/04	From Ch. No.: YD471565	For Vehicles Without Distributor, Black Boot, VVT Eng	2	2	U4001	48055
1.6	Hbk, Sal	16K4F	05/04→05/05	With Bracket, To Ch. No.: YD471564	For Vehicles With Distributor	1	2	U1006	48059
1.6	Hbk, Sal	16K4F	05/04→05/05	From Ch. No.: YD471565	For Vehicles Without Distributor, Black Boot, VVT Eng	2	2	U4001	48055
1.8	Hbk, Sal	18K4F	02/00→05/04	With Bracket, To Ch. No.: YD471564	Without Variable Valve Timing, With Distributor	1	2	U1006	48059
1.8	Hbk, Sal	18K4F	02/00→05/04	From Ch. No.: YD471565	Without Variable Valve Timing, Without Distributor, Black Boot, VVT Eng	2	2	U4001	48055
1.8	Hbk, Sal	18K4F	02/00→05/04		With Variable Valve Timing, Red Boot, Non VVT Eng	2	2	U4002	48100
1.8	Hbk, Sal	18K4F	05/04→05/05	With Bracket, To Ch. No.: YD471564	Without Variable Valve Timing, With Distributor	1	2	U1006	48059
1.8	Hbk, Sal	18K4F	05/04→05/05	From Ch. No.: YD471565	Without Variable Valve Timing, Without Distributor, Black Boot, VVT Eng	2	2	U4001	48055
1.8	Hbk, Sal	18K4F	05/04→05/05		With Variable Valve Timing, Red Boot, Non VVT Eng	2	2	U4002	48100
2.0	Sal		11/99→07/03			3	3	U5005	48009
2.0	Sal		11/99→07/03			6	3	U5026	48091
75 (99→04)									
1.8	Est	18K4F	08/01→04/04		For Vehicles Without Distributor, Black Boot, VVT Eng	2	2	U4001	48055
1.8	Est, Sal	18K4F	03/04→05/05		For Vehicles Without Distributor, Black Boot, VVT Eng	2	2	U4001	48055
1.8	Sal	18K4F	02/99→04/04		For Vehicles Without Distributor, Black Boot, VVT Eng	2	2	U4001	48055
1.8, T	Est, Sal	18K4G	03/04→05/05		For Vehicles Without Distributor, Black Boot, VVT Eng	2	2	U4001	48055
1.8, T	Est, Sal	18K4G	05/03→04/04		For Vehicles Without Distributor, Black Boot, VVT Eng	2	2	U4001	48055
2.0	Est		03/01→04/04			3	3	U5005	48009
2.0	Est		03/01→04/04			6	3	U5026	48091
2.0	Sal		02/99→04/04			3	3	U5005	48009
2.0	Sal		02/99→04/04			6	3	U5026	48091
2.5	Est	KV6	03/04→05/05		2 Bolt Fixing	6	3	U5005	48009
2.5	Est	KV6	03/04→05/05		1 Bolt Fixing	6	3	U5026	48091
2.5	Est	KV6	08/01→04/04		2 Bolt Fixing	6	3	U5005	48009
2.5	Est	KV6	08/01→04/04		1 Bolt Fixing	6	3	U5026	48091
2.5	Sal	25K4F	03/04→05/05		2 Bolt Fixing	6	3	U5005	48009
2.5	Sal	25K4F	03/04→05/05		1 Bolt Fixing	6	3	U5026	48091
2.5	Sal	25K4F, KV6	02/99→04/04		2 Bolt Fixing	6	3	U5005	48009
2.5	Sal	25K4F, KV6	02/99→04/04		1 Bolt Fixing	6	3	U5026	48091
2.5, Limousine	Sal	25K4F	03/04→05/05		2 Bolt Fixing	6	3	U5005	48009
2.5, Limousine	Sal	25K4F	03/04→05/05		1 Bolt Fixing	6	3	U5026	48091
2.5, Vanden Plas Limousine	Sal	25K4F	03/02→04/04		2 Bolt Fixing	6	3	U5005	48009
2.5, Vanden Plas Limousine	Sal	25K4F	03/02→04/04		1 Bolt Fixing	6	3	U5026	48091
100 Series (94→98)									
1.1		11K2A, 11K2D	12/94→12/98	With Bracket	For Vehicles With Distributor	1	2	U1006	48059
1.1		11K2A, 11K2D	12/94→12/98		For Vehicles With Distributor	1	2	U1076	48339
1.4	Cnv	14K2A, 14K2D	06/95→07/97	With Bracket	For Vehicles With Distributor	1	2	U1006	48059

LITRE / MODEL	BODY	ENGINE TYPE	DATE	ADDITIONAL INFORMATION	FITMENT INFORMATION	NO. OF COILS	NO. OF PINS	PART NO.	STOCK NO.
ROVER (continued)									
100 Series (94→98)									
1.4	Cnv	14K2A, 14K2D	06/95→07/97		For Vehicles With Distributor	1	2	U1076	48339
1.4	Hbk	14K2A, 14K2D	12/94→12/98	With Bracket	For Vehicles With Distributor	1	2	U1006	48059
1.4	Hbk	14K2A, 14K2D	12/94→12/98		For Vehicles With Distributor	1	2	U1076	48339
200 Series (84→90)									
1.6, Carburettor		16H	03/85→09/89		For Vehicles With Distributor	1	2	U1076	48339
1.6, Injection		16H	03/85→09/89		For Vehicles With Distributor	1	2	U1076	48339
200 Series (89→96)									
1.4		14K2A	09/93→10/95		For Vehicles With Distributor	1	2	U1076	48339
1.4		14K2D	09/93→10/95	With Bracket, To Ch. No.: YD471564	For Vehicles With Distributor	1	2	U1006	48059
1.4		14K2D	09/93→10/95	From Ch. No.: YD471565	For Vehicles Without Distributor, Black Boot, VVT Eng	2	2	U4001	48055
1.4		14K4C	01/90→11/93	With Bracket	For Vehicles With Distributor	1	2	U1006	48059
1.4		14K4F	12/92→10/95	With Bracket	For Vehicles With Distributor	1	2	U1006	48059
1.4		14K4F	12/92→10/95		For Vehicles With Distributor	1	2	U1076	48339
1.4		14K4F	12/92→10/95		For Vehicles Without Distributor, Black Boot, VVT Eng	2	2	U4001	48055
1.6		D16A9	09/90→12/93			1	2	U1016	48098
1.6		D16Z2	10/92→10/95	With Bracket	For Vehicles With Distributor	1	2	U1006	48059
1.6		D16Z2	10/92→10/95			1	2	U1016	48098
2.0		20M4F	09/91→11/93		For Vehicles With Distributor	1	2	U1076	48339
2.0, Turbo		20T4G	11/93→05/95	With Bracket		1	4	U1044	48191
200 Series (92→99)									
1.1		11K2D	01/98→03/00	With Bracket, To Ch. No.: YD471564	For Vehicles With Distributor	1	2	U1006	48059
1.1		11K2D	01/98→03/00	From Ch. No.: YD471565	For Vehicles Without Distributor, Black Boot, VVT Eng	2	2	U4001	48055
1.4		14K4F	01/93→03/96	With Bracket	For Vehicles With Distributor	1	2	U1006	48059
1.4		14K4F	01/93→03/96		For Vehicles With Distributor	1	2	U1076	48339
1.4		14K4F	01/93→03/96		For Vehicles Without Distributor, Black Boot, VVT Eng	2	2	U4001	48055
1.4		14K2F	11/95→03/00	With Bracket	For Vehicles With Distributor	1	2	U1006	48059
1.4		14K4F	11/95→03/00	With Bracket	For Vehicles With Distributor	1	2	U1006	48059
1.6	Cnv	D16A8	04/92→10/95			1	2	U1016	48098
1.6	Cnv, Cpe	16K4F	03/96→04/99	With Bracket, To Ch. No.: YD471564	For Vehicles With Distributor	1	2	U1006	48059
1.6	Cnv, Cpe	16K4F	03/96→04/99	From Ch. No.: YD471565	For Vehicles Without Distributor, Black Boot, VVT Eng	2	2	U4001	48055
1.6	Cpe	D16Z2	10/92→10/95	With Bracket	For Vehicles With Distributor	1	2	U1006	48059
1.6	Cpe	D16Z2	10/92→10/95			1	2	U1016	48098
1.6		16K4F	11/95→03/00	With Bracket, To Ch. No.: YD471564	For Vehicles With Distributor	1	2	U1006	48059
1.6		16K4F	11/95→03/00	From Ch. No.: YD471565	For Vehicles Without Distributor, Black Boot, VVT Eng	2	2	U4001	48055
1.8		18K4F	08/99→10/99	With Bracket, To Ch. No.: YD471564	For Vehicles With Distributor	1	2	U1006	48059
1.8		18K4F	08/99→10/99	From Ch. No.: YD471565	For Vehicles Without Distributor, Black Boot, VVT Eng	2	2	U4001	48055
1.8, 200vi / BRM		18K4K	10/96→03/00	From Ch. No.: YD471565	With Variable Valve Timing, Red Boot, Non VVT Eng	2	2	U4002	48100
1.8, VVC		18K4K	03/96→04/99	From Ch. No.: YD471565	With Variable Valve Timing, Red Boot, Non VVT Eng	2	2	U4002	48100
2.0		20T4H	05/94→03/96		For Vehicles With Distributor	1	2	U1076	48339
2.0, Turbo		20T4G	10/92→03/96	With Bracket		1	4	U1044	48191
400 Series (90→96)									
1.4		14K4F	01/93→04/95	With Bracket	For Vehicles With Distributor	1	2	U1006	48059
1.4		14K4F	01/93→04/95		For Vehicles With Distributor	1	2	U1076	48339
1.4		14K4F	01/93→04/95		For Vehicles Without Distributor, Black Boot, VVT Eng	2	2	U4001	48055
1.6		D16A7	04/90→10/92			1	2	U1016	48098
1.6		D16A9	04/90→12/91			1	2	U1016	48098

LITRE / MODEL	BODY	ENGINE TYPE	DATE	ADDITIONAL INFORMATION	FITMENT INFORMATION	NO. OF COILS	NO. OF PINS	PART NO.	STOCK NO.
ROVER (continued)									
400 Series (90→96)									
1.6		D16Z2	10/92→04/95	With Bracket	For Vehicles With Distributor	1	2	U1006	48059
1.6		D16Z2	10/92→04/95			1	2	U1016	48098
1.6, Tourer		D16Z2	06/94→03/96	With Bracket	For Vehicles With Distributor	1	2	U1006	48059
1.6, Tourer		D16Z2	06/94→03/96			1	2	U1016	48098
1.6, Tourer		D16Z2	06/94→03/96		For Vehicles With Distributor	1	2	U1020	48111
2.0, Tourer		20T4H	06/94→03/96		For Vehicles Without Distributor	1	4	U2017	48067
2.0, Turbo		20T4G	01/93→04/95	With Bracket		1	4	U1044	48191
400 Series (95→00)									
1.4		14K4F	05/95→03/00	With Bracket	For Vehicles With Distributor	1	2	U1006	48059
1.4		14K4F	05/95→03/00		For Vehicles With Distributor	1	2	U1076	48339
1.4		14K4F	05/95→03/00		For Vehicles Without Distributor, Black Boot, VVT Eng	2	2	U4001	48055
1.4			04/99→07/00	With Bracket, To Ch. No.: YD471564	For Vehicles With Distributor	1	2	U1006	48059
1.4			04/99→07/00		For Vehicles Without Distributor, Black Boot, VVT Eng	2	2	U4001	48055
1.6, Automatic	Hbk	D16Y2	06/95→03/00	With Bracket	For Vehicles With Distributor	1	2	U1006	48059
1.6, Automatic	Hbk	D16Y2	06/95→03/00		For Vehicles With Distributor	1	2	U1020	48111
1.6, Automatic	Sal	D16Y2	05/95→12/99	With Bracket	For Vehicles With Distributor	1	2	U1006	48059
1.6, Automatic	Sal	D16Y2	05/95→12/99		For Vehicles With Distributor	1	2	U1020	48111
1.6, Manual	Hbk, Sal	16K4F	05/95→03/00	With Bracket, To Ch. No.: YD471564	For Vehicles With Distributor	1	2	U1006	48059
1.6, Manual	Hbk, Sal	16K4F	05/95→03/00	From Ch. No.: YD471565	For Vehicles Without Distributor, Black Boot, VVT Eng	2	2	U4001	48055
1.6, Tourer	Est	D16Z2	03/96→11/98	With Bracket	For Vehicles With Distributor	1	2	U1006	48059
1.6, Tourer	Est	D16Z2	03/96→11/98			1	2	U1016	48098
1.6, Tourer	Est	D16Z2	03/96→11/98		For Vehicles With Distributor	1	2	U1020	48111
1.8, Tourer VVC		18K4K	06/96→10/97		With Variable Valve Timing, Red Boot, Non VVT Eng	2	2	U4002	48100
2.0	Hbk	20T4H	12/95→03/00		For Vehicles Without Distributor	1	4	U2017	48067
2.0	Sal	20T4H	03/96→03/00		For Vehicles Without Distributor	1	4	U2017	48067
600 Series (93→00)									
1.8		F18A3	03/96→02/99	To Ch. No.: AM246796	For Vehicles With Distributor	1	2	U1004	48054
1.8		F18A3	03/96→02/99	From Ch. No.: YD246797	For Vehicles With Distributor	1	2	U1020	48111
2.0, i		F20Z2	08/93→03/96	To Ch. No.: 246796	For Vehicles With Distributor	1	2	U1004	48054
2.0, i		F20Z2	08/93→03/96	From Ch. No.: YD246797	For Vehicles With Distributor	1	2	U1020	48111
2.0, Si/SLi/GSi		F20Z1	08/93→02/99	To Ch. No.: 246796	For Vehicles With Distributor	1	2	U1004	48054
2.0, Si/SLi/GSi		F20Z1	08/93→02/99	From Ch. No.: YD246797	For Vehicles With Distributor	1	2	U1020	48111
2.0, ti		20T4G	07/94→02/99	From Ch. No.: 246797	For Vehicles Without Distributor	1	4	U2017	48067
2.3		H23A3	10/93→02/99		For Vehicles With Distributor	1	2	U1004	48054
800 Series (86→91)									
2.0, MPI	Hbk	20HD	10/88→11/91		For Vehicles With Distributor	1	2	U1076	48339
2.0, MPI	Sal	20HDM16	10/88→11/91		For Vehicles With Distributor	1	2	U1076	48339
800 Series (91→99)									
2.0	Hbk	20T4H	01/93→02/99		For Vehicles With Distributor	1	2	U1076	48339
2.0	Hbk	20T4H	01/93→02/99		For Vehicles Without Distributor	1	4	U2017	48067
2.0	Sal	20T4H	01/92→02/99		For Vehicles Without Distributor	1	4	U2017	48067
2.0, Vitesse	Hbk, Sal	T16	01/93→02/99		For Vehicles With Distributor	1	2	U1076	48339
2.0, Vitesse	Hbk, Sal	T16	01/93→02/99		For Vehicles Without Distributor	1	4	U2017	48067
Cityrover (03→05)									
1.4		475Si	01/04→06/05		For Vehicles Without Distributor	1	4	U2009	48030
Mini									
1.3, Carburettor	Sal	12A2L	06/92→08/94	To Ch. No.: BD134454	For Vehicles With Distributor	1	2	U1076	48339
1.3, Carburettor	Sal	12A2L	06/92→08/94	From Ch. No.: BD134455	For Vehicles Without Distributor	1	4	U2017	48067
1.3, Cooper	Sal	12A2A	11/91→02/94	To Ch. No.: BD134454	For Vehicles With Distributor	1	2	U1076	48339
1.3, Cooper	Sal	12A2A	11/91→02/94	From Ch. No.: BD134455	For Vehicles Without Distributor	1	4	U2017	48067
1.3, Cooper Cabriolet	Cnv	12A2E	01/93→04/95	To Ch. No.: BD134454	For Vehicles With Distributor	1	2	U1076	48339
1.3, Cooper Cabriolet	Cnv	12A2E	01/93→04/95	From Ch. No.: BD134455	For Vehicles Without Distributor	1	4	U2017	48067

LITRE / MODEL	BODY	ENGINE TYPE	DATE	ADDITIONAL INFORMATION	FITMENT INFORMATION	NO. OF COILS	NO. OF PINS	PART NO.	STOCK NO.
ROVER (continued)									
Mini									
1.3, MPi	Sal	12A2L	10/96→12/00	To Ch. No.: BD134454	For Vehicles With Distributor	1	2	U1076	48339
1.3, MPi	Sal	12A2L	10/96→12/00	From Ch. No.: BD134455	For Vehicles Without Distributor	1	4	U2017	48067
1.3, SPi	Sal	12A2L	05/96→08/96	To Ch. No.: BD134454	For Vehicles With Distributor	1	2	U1076	48339
1.3, SPi	Sal	12A2L	05/96→08/96	From Ch. No.: BD134455	For Vehicles Without Distributor	1	4	U2017	48067
SD1 (76→86)									
2.0, 2000			07/84→10/86		Electronic Ignition (EI), With Distributor	1	2	U1076	48339
2.0, 2000			10/82→06/84		Conventional Coil Ignition (CI), With Distributor	1	2	U1056	48236
2.3, 2300			01/80→06/84		Conventional Coil Ignition (CI), With Distributor	1	2	U1056	48236
2.3, 2300			07/84→10/86		Electronic Ignition (EI), With Distributor	1	2	U1076	48339
2.6, 2600		12C, 13C	07/84→10/86		Electronic Ignition (EI), With Distributor	1	2	U1076	48339
2.6, 2600		12C, 13C	10/80→06/84		Conventional Coil Ignition (CI), With Distributor	1	2	U1056	48236
3.5, 3500		38A, 39A	01/80→10/86		For Vehicles With Distributor	1	2	U1076	48339
3.5, 3500 Injection		30A, 31A	10/82→10/86		For Vehicles With Distributor	1	2	U1076	48339

SAAB									
9-3 (98→02)									
2.0	Cnv, Cpe, Hbk	B204I	03/98→09/99	Red Top	For Vehicles Without Distributor	1	10	U6023	48128
2.0, HOT	Cnv	B205R	09/00→09/02	Red Top	For Vehicles Without Distributor	1	10	U6023	48128
2.0, HOT	Cpe	B205R	09/00→05/02	Red Top	For Vehicles Without Distributor	1	10	U6023	48128
2.0, HOT	Hbk	B204R	09/99→08/00		For Vehicles With Distributor	1	2	U1083	48346
2.0, HOT	Hbk	B204R	09/99→05/02	Red Top	For Vehicles Without Distributor	1	10	U6023	48128
2.0, t	Cnv	B205E	01/01→08/03	Red Top	For Vehicles Without Distributor	1	10	U6023	48128
2.0, T	Cnv	B205L	09/98→09/02	Red Top	For Vehicles Without Distributor	1	10	U6023	48128
2.0, t	Cnv, Cpe, Hbk	B204E	10/98→09/00	Red Top	For Vehicles Without Distributor	1	10	U6023	48128
2.0, t	Cpe, Hbk	B205E	01/01→05/02	Red Top	For Vehicles Without Distributor	1	10	U6023	48128
2.0, T	Cpe, Hbk	B205L	09/98→05/02	Red Top	For Vehicles Without Distributor	1	10	U6023	48128
2.3, T Viggen	Cpe, Hbk		03/99→09/99	Red Top	For Vehicles Without Distributor	1	10	U6023	48128
9-3 (02→12)									
1.8, i	Est	Z18XE	09/05→04/10			1	5	U6003	48011
1.8, i	Sal	Z18XE	01/04→04/10			1	5	U6003	48011
1.8t BioPower	Sal	B207L	05/09→06/11	Red Top	For Vehicles Without Distributor	1	10	U6023	48128
2.0, t		B207E, B207R	05/02→06/11			4	4	U5244	49066
2.0, t	Est	B207L	09/05→04/10	Red Top	For Vehicles Without Distributor	1	10	U6023	48128
2.0, t	Sal	B207L	09/02→04/10	Red Top	For Vehicles Without Distributor	1	10	U6023	48128
2.0, T XWD	Est	B207R	08/09→06/11	Red Top	For Vehicles Without Distributor	1	10	U6023	48128
2.8, T	Cnv	B284L	12/07→06/10			6	4	U5049	48174
2.8, T	Cnv	LP9	02/06→12/07			6	4	U5049	48174
2.8, T	Est	LP9	09/05→12/07			6	4	U5049	48174
2.8, T	Est, Sal	B284L	12/07→04/10			6	4	U5049	48174
2.8, T	Sal		05/05→12/07			6	4	U5049	48174
2.8, Turbo X	Est, Sal	B284R	05/08→04/10			6	4	U5049	48174
9-5 (97→01)									
2.0, t	Est	B205E	10/98→09/00	Red Top	For Vehicles Without Distributor	1	10	U6023	48128
2.0, t	Sal	B205E	09/97→09/00	Red Top	For Vehicles Without Distributor	1	10	U6023	48128
2.3, t	Est	B235E	10/98→09/00	Red Top	For Vehicles Without Distributor	1	10	U6023	48128
2.3, t	Est, Sal	B235E	01/01→09/01	Red Top	For Vehicles Without Distributor	1	10	U6023	48128
2.3, t	Sal	B235E	09/97→09/00	Red Top	For Vehicles Without Distributor	1	10	U6023	48128
9-5 (01→05)									
2.3, t	Est, Sal	B235E	09/01→10/05	Red Top	For Vehicles Without Distributor	1	10	U6023	48128
9-5 (05→10)									
2.3, t	Est, Sal	B235E	09/05→06/09	Red Top	For Vehicles Without Distributor	1	10	U6023	48128
2.8, t	Sal	A28NER	04/10→04/12			6	4	U5130	49072

LITRE / MODEL	BODY	ENGINE TYPE	DATE	ADDITIONAL INFORMATION	FITMENT INFORMATION	NO. OF COILS	NO. OF PINS	PART NO.	STOCK NO.
SAAB (continued)									
90									
2.0		B20I	08/84→12/85		For Vehicles With Distributor	1	2	U1076	48339
99									
2.0		B20C, B20I	01/80→08/84		For Vehicles With Distributor	1	2	U1079	48342
900 (79→93)									
2.0	Cnv	B20I, B202S	09/91→09/93		For Vehicles With Distributor	1	2	U1076	48339
2.0	Cnv	B20I, B202S	10/90→12/90		For Vehicles With Distributor	1	2	U1076	48339
2.0	Hbk	B202S	09/91→07/93		For Vehicles With Distributor	1	2	U1076	48339
2.0, Injection	Hbk	B201XI, BI20	11/80→12/88		For Vehicles With Distributor	1	2	U1076	48339
2.0, Injection	Sal	BI20	01/80→12/80		For Vehicles With Distributor	1	2	U1076	48339
2.0, S (LPT)	Cnv	B202S	04/92→09/93		For Vehicles With Distributor	1	2	U1076	48339
2.0, S (LPT)	Hbk	B202S	09/91→07/93		For Vehicles With Distributor	1	2	U1076	48339
2.0, Single Carburettor	Hbk	B20, B201XC	08/83→10/87		For Vehicles With Distributor	1	2	U1076	48339
2.0, Single Carburettor	Sal	B20, B201XC	07/82→10/88		For Vehicles With Distributor	1	2	U1076	48339
2.0, Turbo	Cnv	B202XL	11/86→12/93		For Vehicles With Distributor	1	2	U1076	48339
2.0, Turbo	Hbk	B201S, BSI20	01/80→07/85		For Vehicles With Distributor	1	2	U1076	48339
2.0, Turbo	Hbk, Sal	B202XL	05/84→12/88		For Vehicles With Distributor	1	2	U1076	48339
2.0, Turbo	Sal	B201S, BSI20	10/80→07/85		For Vehicles With Distributor	1	2	U1076	48339
2.0, Turbo	Sal	B201XL	01/86→12/88		For Vehicles With Distributor	1	2	U1076	48339
2.0, Turbo	Sal	B202XL	01/89→09/90		For Vehicles With Distributor	1	2	U1076	48339
900 (93→98)									
2.0	Cnv	B204I	10/94→02/98	Red Top	For Vehicles Without Distributor	1	10	U6023	48128
2.0	Cpe	B204I, B206I	12/93→02/98	Red Top	For Vehicles Without Distributor	1	10	U6023	48128
2.0	Hbk	B204I	08/94→02/98	Red Top	For Vehicles Without Distributor	1	10	U6023	48128
2.0, Turbo	Cnv	B204L	06/94→02/98	Red Top	For Vehicles Without Distributor	1	10	U6023	48128
2.0, Turbo	Cpe, Hbk	B204L	03/94→02/98	Red Top	For Vehicles Without Distributor	1	10	U6023	48128
2.3	Cnv	B234I	06/94→02/98	Red Top	For Vehicles Without Distributor	1	10	U6023	48128
2.3	Cpe	B234I	03/94→02/98	Red Top	For Vehicles Without Distributor	1	10	U6023	48128
2.3	Hbk	B234I	10/93→02/98	Red Top	For Vehicles Without Distributor	1	10	U6023	48128
2.5	Cnv	B258I	10/94→08/95	Angular Connector		1	4	U2043	48193
2.5	Cnv, Hbk	B258I	09/95→02/98	Oval Connector		1	4	U2068	48325
2.5	Cpe	B258I	03/94→08/95	Angular Connector		1	4	U2043	48193
2.5	Cpe	B258I	09/95→08/96	Oval Connector		1	4	U2068	48325
2.5	Hbk	B258I	10/93→08/95	Angular Connector		1	4	U2043	48193
9000									
2.0	Hbk	B20I, B202XI	04/86→08/88		For Vehicles With Distributor	1	2	U1076	48339
2.0	Hbk	B20I, B202XI	04/86→08/88	Red Top	For Vehicles Without Distributor	1	10	U6023	48128
2.0	Hbk	B20I, B204I	10/91→10/98		For Vehicles With Distributor	1	2	U1076	48339
2.0	Hbk	B20I, B204I	10/91→10/98	Red Top	For Vehicles Without Distributor	1	10	U6023	48128
2.0	Hbk		10/88→01/90		For Vehicles With Distributor	1	2	U1076	48339
2.0	Hbk		10/88→01/90	Red Top	For Vehicles Without Distributor	1	10	U6023	48128
2.0	Sal	B20I, B204I	09/90→01/93		For Vehicles With Distributor	1	2	U1076	48339
2.0	Sal	B20I, B204I	09/90→01/93	Red Top	For Vehicles Without Distributor	1	10	U6023	48128
2.0	Sal	B20I, B204I	09/93→04/95	Red Top	For Vehicles Without Distributor	1	10	U6023	48128
2.0	Sal		10/88→08/90		For Vehicles With Distributor	1	2	U1076	48339
2.0	Sal		10/88→08/90	Red Top	For Vehicles Without Distributor	1	10	U6023	48128
2.0, Eco Power	Hbk	B202S, B204E	09/93→10/98	Red Top	For Vehicles Without Distributor	1	10	U6023	48128
2.0, Eco Power	Sal	B204E	09/93→09/97	Red Top	For Vehicles Without Distributor	1	10	U6023	48128
2.0, Turbo	Hbk	B202XL	10/85→10/90	Red Top	For Vehicles Without Distributor	1	10	U6023	48128
2.0, Turbo	Hbk, Sal	B202XL	10/90→09/92		For Vehicles With Distributor	1	2	U1076	48339
2.0, Turbo	Sal	B202XL	05/88→10/90	Red Top	For Vehicles Without Distributor	1	10	U6023	48128
2.3	Hbk	B234I	10/89→09/93		For Vehicles With Distributor	1	2	U1076	48339
2.3	Hbk	B234I	10/89→09/93	Red Top	For Vehicles Without Distributor	1	10	U6023	48128
2.3	Sal	B234I	10/89→01/92		For Vehicles With Distributor	1	2	U1076	48339
2.3	Sal	B234I	10/89→01/92	Red Top	For Vehicles Without Distributor	1	10	U6023	48128
2.3, Aero	Hbk	B234R	02/93→09/97	Red Top	For Vehicles Without Distributor	1	10	U6023	48128
2.3, Eco Power	Hbk, Sal	B234E	09/93→09/97	Red Top	For Vehicles Without Distributor	1	10	U6023	48128
2.3, Griffin	Hbk	B234L	01/96→09/97	Red Top	For Vehicles Without Distributor	1	10	U6023	48128

LITRE / MODEL	BODY	ENGINE TYPE	DATE	ADDITIONAL INFORMATION	FITMENT INFORMATION	NO. OF COILS	NO. OF PINS	PART NO.	STOCK NO.
SAAB (continued)									
9000									
2.3, Griffin	Sal	B234L	05/95→08/96	Red Top	For Vehicles Without Distributor	1	10	U6023	48128
2.3, Turbo	Hbk, Sal	B234L	05/95→09/97	Red Top	For Vehicles Without Distributor	1	10	U6023	48128

SEAT									
Alhambra (96→00)									
1.8		AJH	05/98→02/00			4	3	U5004	48008
1.8		AWC	06/00→08/00			4	4	U5022	48082
2.0		ADY	06/96→02/00		Incl. Control Unit, For Vehicles With Distributor	1	3	U1001	48000
2.0		ATM	06/00→08/00		For Vehicles Without Distributor	1	4	U2003	48010
Alhambra (00→11)									
1.8		AWC	07/00→09/03			4	4	U5022	48082
2.0		ATM	07/00→03/10		For Vehicles Without Distributor	1	4	U2003	48010
2.8		AUE, AYL	07/00→10/05			6	4	U5011	48035
Alhambra (10→)									
1.4, TSI 150		CAVA, CNWB	09/10→			4	4	U5002	48003
Altea (04→)									
1.2, TSI 105		CBZB	04/10→		For Vehicles Without Distributor	1	4	U2003	48010
1.2, XL TSI 105		CBZB	04/10→		For Vehicles Without Distributor	1	4	U2003	48010
1.4		BXW, CGGB	04/09→			4	4	U5002	48003
1.4, TSI 125		CAXC	04/09→			4	4	U5002	48003
1.4, XL TSI 125		CAXC	04/09→			4	4	U5002	48003
1.6		BGU, BSE, BSF, CCSA, CMXA	07/04→12/10		For Vehicles Without Distributor	1	4	U2003	48010
1.6, XL		BSE, BSF, CCSA, CMXA	01/07→12/10		For Vehicles Without Distributor	1	4	U2003	48010
1.8, XL TFSI		BYT, BZB, CDAA	01/07→12/09			4	4	U5015	48042
2.0, Freetrack TFSI		BWA	10/07→05/09			4	4	U5015	48042
2.0, FSi		BLR, BLY, BVY, BVZ	07/04→03/08			4	4	U5015	48042
2.0, TFSI FR		BWA	06/06→05/09			4	4	U5015	48042
2.0, XL FSI		BVY, BVZ	01/07→03/09			4	4	U5015	48042
Arosa (97→01)									
1.0		AER, ALL	09/97→09/99		Incl. Control Unit, For Vehicles With Distributor	1	3	U1001	48000
1.0		ANV, AUC, ALD	01/99→01/01		For Vehicles Without Distributor	1	4	U2003	48010
1.4		AEX, AKV, APQ	09/97→09/99		Incl. Control Unit, For Vehicles With Distributor	1	3	U1001	48000
1.4		AFK, AUB	01/00→01/01		For Vehicles Without Distributor	1	4	U2003	48010
1.4		ANW, AUD	01/99→01/01		For Vehicles Without Distributor	1	4	U2003	48010
Arosa (01→04)									
1.0		ANV, AUC, ALD	01/01→06/04		For Vehicles Without Distributor	1	4	U2003	48010
1.4		AFK, AUB	01/01→06/04		For Vehicles Without Distributor	1	4	U2003	48010
1.4		ANW, AUD	01/01→06/04		For Vehicles Without Distributor	1	4	U2003	48010
Cordoba (94→99)									
1.4	Sal	ABD, AEX, AKV, APQ	04/95→06/99		Incl. Control Unit, For Vehicles With Distributor	1	3	U1001	48000
1.6	Sal	ABU, AEE, ALM	05/94→07/97		Incl. Control Unit, For Vehicles With Distributor	1	3	U1001	48000
1.6	Sal	AFT, AKL	12/96→10/99		Incl. Control Unit, For Vehicles With Distributor	1	3	U1001	48000
1.6, Varío	Est	AEE, ALM	01/98→06/99		Incl. Control Unit, For Vehicles With Distributor	1	3	U1001	48000
1.6, Varío	Est	AFT	01/98→06/99		Incl. Control Unit, For Vehicles With Distributor	1	3	U1001	48000
1.8	Sal	ABS, ACC, ADZ	05/94→03/95		Incl. Control Unit, For Vehicles With Distributor	1	3	U1001	48000
2.0	Cpe		12/96→10/99		Incl. Control Unit, For Vehicles With Distributor	1	3	U1001	48000
2.0	Sal	2E, AGG	05/94→12/96		Incl. Control Unit, For Vehicles With Distributor	1	3	U1001	48000

LITRE / MODEL	BODY	ENGINE TYPE	DATE	ADDITIONAL INFORMATION	FITMENT INFORMATION	NO. OF COILS	NO. OF PINS	PART NO.	STOCK NO.
SEAT (continued)									
Cordoba (99→01)									
1.4	Sal	APE, AUA	05/00→12/01		For Vehicles Without Distributor	1	4	U2003	48010
1.4, Vario	Est	APE, AUA	05/00→12/01		For Vehicles Without Distributor	1	4	U2003	48010
1.6	Sal	ALM	10/99→12/00		Incl. Control Unit, For Vehicles With Distributor	1	3	U1001	48000
1.6, Vario	Est	ALM	10/99→12/00		Incl. Control Unit, For Vehicles With Distributor	1	3	U1001	48000
Cordoba (02→06)									
1.4		BBY, BKY	11/02→12/06			4	4	U5002	48003
Exeo (09→)									
2.0, ST TSI 197	Est	BWE	07/09→12/10			4	4	U5015	48042
2.0, ST TSI 211	Est	CDND	08/10→			4	4	U5015	48042
2.0, TSI 197	Sal	BWE	04/09→12/10			4	4	U5015	48042
2.0, TSI 211	Sal	CDND	08/10→			4	4	U5015	48042
Ibiza (85→93)									
0.9		09NCA, 146A000	02/87→12/92		For Vehicles With Distributor	1	2	U1079	48342
1.2		021A1000	10/85→12/91		For Vehicles With Distributor	1	2	U1076	48339
1.2, Injection		021A1000	01/92→12/93		For Vehicles With Distributor	1	2	U1076	48339
1.5		021A2000	10/86→05/90		For Vehicles With Distributor	1	2	U1076	48339
1.5		021C.2000	05/90→12/92		For Vehicles With Distributor	1	2	U1076	48339
1.5, Injection		021B.2000	07/89→05/93		For Vehicles With Distributor	1	2	U1076	48339
1.7		021B.3000	01/92→05/93		For Vehicles With Distributor	1	2	U1076	48339
Ibiza (93→99)									
1.0, MPI		AER	12/96→01/98		Incl. Control Unit, For Vehicles With Distributor	1	3	U1001	48000
1.0, SPi		AAU	03/95→09/96		Incl. Control Unit, For Vehicles With Distributor	1	3	U1001	48000
1.3		2G	10/93→06/94		Incl. Control Unit, For Vehicles With Distributor	1	6	U1003	48039
1.3		AAV	10/93→06/94		Incl. Control Unit, For Vehicles With Distributor	1	3	U1001	48000
1.4		ABD, AEX, AKV, APQ	05/94→08/99		Incl. Control Unit, For Vehicles With Distributor	1	3	U1001	48000
1.6		ABU, AEE, ALM	10/93→12/96		Incl. Control Unit, For Vehicles With Distributor	1	3	U1001	48000
1.6		AFT	12/96→12/97		Incl. Control Unit, For Vehicles With Distributor	1	3	U1001	48000
1.8		ABS, ADZ	10/93→06/94	To Ch. No.: 6KZ-R-132108/ 6KZ-R-672416	Incl. Control Unit, For Vehicles With Distributor	1	6	U1003	48039
1.8		ABS, ADZ, ACC	10/93→06/94	From Ch. No.: 6KZ-R-132109/ 6KZ-R-672417	Incl. Control Unit, For Vehicles With Distributor	1	3	U1001	48000
1.8		ADL	10/94→08/96		Incl. Control Unit, For Vehicles With Distributor	1	3	U1001	48000
2.0		2E, AGG	10/93→08/99	From Ch. No.: 6KZ-R-132109/ 6KZ-R-672417	Incl. Control Unit, For Vehicles With Distributor	1	3	U1001	48000
2.0		2E, AGG	10/93→08/99	To Ch. No.: 6KZ-R-132108/ 6KZ-R-672416	Incl. Control Unit, For Vehicles With Distributor	1	6	U1003	48039
2.0		ABF	12/96→08/99		Incl. Control Unit, For Vehicles With Distributor	1	3	U1001	48000
Ibiza (99→02)									
1.4		AKK, ANW, AUD	10/99→02/02		For Vehicles Without Distributor	1	4	U2003	48010
1.6		AEH, AKL, APF, AUR	10/99→02/02		For Vehicles Without Distributor	1	4	U2003	48010
1.8, Cupra		AQX	10/00→02/02			4	4	U5022	48082
1.8, Cupra		AYP	10/00→02/02	From Ch. No.: 6K.1..134 297		4	4	U5003	48005
1.8, Cupra R			03/01→05/02			4	4	U5003	48005
Ibiza (02→09)									
1.2		AZQ, BME	04/02→06/06			3	4	U5002	48003
1.2		BXV	12/06→04/09			3	4	U5002	48003
1.4		AUB	04/02→09/03		For Vehicles Without Distributor	1	4	U2003	48010
1.4		AUB	08/06→04/09		For Vehicles Without Distributor	1	4	U2003	48010
1.4		BBY, BKY	04/02→12/07			4	4	U5002	48003

LITRE / MODEL	BODY	ENGINE TYPE	DATE	ADDITIONAL INFORMATION	FITMENT INFORMATION	NO. OF COILS	NO. OF PINS	PART NO.	STOCK NO.
SEAT (continued)									
Ibiza (02→09)									
1.4		BBZ	04/02→09/03			4	4	U5002	48003
1.4		BBZ	08/06→04/09			4	4	U5002	48003
1.4		BXW	08/06→12/08			4	4	U5002	48003
1.8, Cupra		BBU, BLZ	06/04→02/08			4	4	U5003	48005
1.8, FR		BJX, BKV	12/03→05/08			4	4	U5003	48005
2.0		AZL, BBX	08/03→10/04		For Vehicles Without Distributor	1	4	U2003	48010
Ibiza (08→)									
1.2	Hbk	CGPB	10/09→05/12			3	4	U5002	48003
1.2, ST TSI 70	Est	CGPA	04/12→			3	4	U5002	48003
1.2, ST TSI 105	Est	CBZB	09/10→		For Vehicles Without Distributor	1	4	U2003	48010
1.2, TSI 70	Hbk	BZG, CGPA	07/08→05/12			3	4	U5002	48003
1.2, TSI 105	Hbk	CBZB	09/10→		For Vehicles Without Distributor	1	4	U2003	48010
1.4	Hbk	BXW, CGGB	07/08→			4	4	U5002	48003
1.4, ST	Est	CGGB	05/10→			4	4	U5002	48003
1.4, TSI 150	Hbk	CAVE, CNUB, CTHF, CTJB	10/09→			4	4	U5002	48003
1.4, TSI 180	Hbk	CAVE, CTHE, CTJC	06/09→09/12			4	4	U5002	48003
1.6	Hbk	BTS	07/08→05/11			4	4	U5002	48003
Inca (96→04)									
1.4		AEX, AKV, APQ, AUD	05/98→10/99		Incl. Control Unit, For Vehicles With Distributor	1	3	U1001	48000
Leon (00→05)									
1.4		AHW, AXP	03/00→10/05		For Vehicles Without Distributor	1	4	U2003	48010
1.4		BCA	03/00→10/05			4	4	U5002	48003
1.6		AEH, AKL, APF	03/00→10/00		For Vehicles Without Distributor	1	4	U2003	48010
1.6		AUS	10/00→10/05		For Vehicles Without Distributor	1	4	U2003	48010
1.6		AZD, BCB	01/02→10/05			4	4	U5002	48003
1.8, 20v		AGN, APG	03/00→10/05		For Vehicles Without Distributor	1	4	U2003	48010
1.8, 20v T Cupra R		AMK	07/02→10/03			4	4	U5003	48005
1.8, 20v T Cupra R		BAM	10/03→10/05			4	4	U5003	48005
1.8, 20v T Cupra/Sport		APP	03/00→10/05			4	4	U5022	48082
1.8, 20v T Cupra/Sport		AUQ	03/00→10/05			4	4	U5003	48005
Leon (05→13)									
1.2, TSI 105		CBZB	02/10→		For Vehicles Without Distributor	1	4	U2003	48010
1.4		BXW, CGGB	04/09→			4	4	U5002	48003
1.4, TSI 125		CAXC	11/07→			4	4	U5002	48003
1.6		BFO, BGU, BSE, BSF, CCSA, CMXA	09/05→12/10		For Vehicles Without Distributor	1	4	U2003	48010
2.0, FSi		BLR, BLY, BVY, BVZ	09/05→08/07			4	4	U5015	48042
2.0, TFSi		BWA1	10/05→05/06			4	4	U5015	48042
2.0, TFSi FR		BWA	08/06→03/09			4	4	U5015	48042
2.0, TSI 211		CCZB	06/09→			4	4	U5015	48042
2.0, TSI 240 Cupra		BWJ, CDLD	03/07→03/12			4	4	U5015	48042
2.0, TSI 265 Cupra R		CDLA	10/09→			4	4	U5015	48042
Leon (13→)									
1.2, TSI 105		CJZA	01/13→			4	4	U5153	48408
1.2, TSI 105		CBZB	02/10→			1	4	U2003	48010
1.4, TSI 140		CPTA, CHPA	01/13→			4	4	U5153	48408
1.8, TFSi 180	Hbk, Est	CDA, CJSA	01/13→			4	4	U5154	48409
Malaga (85→92)									
1.2	Hbk	021A1000	10/85→10/86		For Vehicles With Distributor	1	2	U1076	48339
1.2	Sal	021A1000	10/85→06/90		For Vehicles With Distributor	1	2	U1076	48339
1.5	Sal	021A2000	10/85→05/89		For Vehicles With Distributor	1	2	U1076	48339
Marbella (88→95)									
0.8, 850		08NCA	05/88→07/92	With Bracket	For Vehicles Without Distributor	2	4	U3008	48060
0.8, 850		08NCA	05/88→07/92		For Vehicles With Distributor	1	2	U1079	48342
0.9		09NCA, 100GL7000	05/88→11/92	With Bracket	For Vehicles Without Distributor	2	4	U3008	48060
0.9		09NCA, 100GL7000	05/88→11/92		For Vehicles With Distributor	1	2	U1079	48342

LITRE / MODEL	BODY	ENGINE TYPE	DATE	ADDITIONAL INFORMATION	FITMENT INFORMATION	NO. OF COILS	NO. OF PINS	PART NO.	STOCK NO.
SEAT (continued)									
Marbella (88→95)									
0.9, Catalyst		09NCB, 100GL7000	11/92→03/95	With Bracket	For Vehicles Without Distributor	2	4	U3008	48060
0.9, Catalyst		09NCB, 100GL7000	11/92→03/95		For Vehicles With Distributor	1	2	U1079	48342
Mii (12→)									
1.0		CHYA	03/12→			4	4	U5153	48408
1.0		CHYB	03/12→			4	4	U5153	48408
Terra (87→94)									
0.9		09NCA, 09NCB	08/87→12/93		Without CAT, With Distributor	1	2	U1079	48342
0.9		09NCA, 09NCB	08/87→12/93		With CAT, Without Distributor	2	3	U3008	48060
Terra Vista (87→94)									
0.9		09NCA, 09NCB	07/89→12/93		Without CAT, With Distributor	1	2	U1079	48342
0.9		09NCA, 09NCB	07/89→12/93		With CAT, Without Distributor	2	3	U3008	48060
Toledo (91→98)									
1.6		1F	04/95→12/96		Incl. Control Unit, For Vehicles With Distributor	1	3	U1001	48000
1.6		1F	04/95→12/96		Incl. Control Unit, For Vehicles With Distributor	1	6	U1003	48039
1.6		1F, ABN, EZ	10/91→04/95		Incl. Control Unit, For Vehicles With Distributor	1	3	U1001	48000
1.6		1F, ABN, EZ	10/91→04/95		Incl. Control Unit, For Vehicles With Distributor	1	6	U1003	48039
1.6		AFT	12/96→03/99		Incl. Control Unit, For Vehicles With Distributor	1	3	U1001	48000
1.6		AFT	12/96→03/99		Incl. Control Unit, For Vehicles With Distributor	1	6	U1003	48039
1.8		ABS, ACC, ADZ	04/95→12/96		Incl. Control Unit, For Vehicles With Distributor	1	3	U1001	48000
1.8		ABS, ACC, ADZ	04/95→12/96		Incl. Control Unit, For Vehicles With Distributor	1	6	U1003	48039
1.8		KR, PL	10/91→01/95			1	2	U1080	48343
1.8		RP	10/91→04/95			1	2	U1080	48343
2.0		2E, AGG	10/91→03/99		Incl. Control Unit, For Vehicles With Distributor	1	3	U1001	48000
2.0		2E, AGG	10/91→03/99		Incl. Control Unit, For Vehicles With Distributor	1	6	U1003	48039
2.0		ABF	10/94→03/99		Incl. Control Unit, For Vehicles With Distributor	1	3	U1001	48000
2.0		ABF	10/94→03/99		Incl. Control Unit, For Vehicles With Distributor	1	6	U1003	48039
Toledo (98→05)									
1.6		AEH, AKL, APF	04/99→08/00		For Vehicles Without Distributor	1	4	U2003	48010
1.8, 20v		AGN, APG	04/99→03/05		For Vehicles Without Distributor	1	4	U2003	48010
1.8, 20v T		APP, AUQ	08/03→03/05			4	4	U5003	48005
2.3		AGZ	04/99→10/00			1	6	U2033	48150
2.3		AQN	05/01→03/05			5	4	U5011	48035
Toledo (04→10)									
1.6		BGU, BSE, BSF	12/04→03/08		For Vehicles Without Distributor	1	4	U2003	48010
2.0, FSI		BLR, BLY, BVY, BVZ	12/04→12/06			4	4	U5015	48042

SKODA									
Citigo									
1.0		CHYA, CHYB	10/11→			4	4	U5153	48408
Cube Van (97→01)									
1.3			03/97→06/98	Angular Connector	For Vehicles Without Distributor	1	4	U6033	48234
1.6			06/98→12/01		Incl. Control Unit, For Vehicles With Distributor	1	3	U1001	48000
Estelle/105>135 MK 1									
1.0, 105			01/80→01/84		For Vehicles With Distributor	1	2	U1056	48236
1.2, 120			01/80→01/84		For Vehicles With Distributor	1	2	U1056	48236

LITRE / MODEL	BODY	ENGINE TYPE	DATE	ADDITIONAL INFORMATION	FITMENT INFORMATION	NO. OF COILS	NO. OF PINS	PART NO.	STOCK NO.
SKODA (continued)									
Estelle/105>135 MK 2									
1.0, 105		742, 10	01/84→08/88		For Vehicles With Distributor	1	2	U1056	48236
1.2, 120		742.12X	01/84→05/87		For Vehicles With Distributor	1	2	U1056	48236
1.2, 120			01/84→03/90		For Vehicles With Distributor	1	2	U1056	48236
1.3, 130			03/85→08/88		For Vehicles With Distributor	1	2	U1056	48236
Estelle/105>135 Rapid									
1.2, 120	Cpe		10/82→12/84		For Vehicles With Distributor	1	2	U1056	48236
1.3, 130	Cnv		06/87→08/88		For Vehicles With Distributor	1	2	U1056	48236
1.3, 130	Cpe		03/85→08/88		For Vehicles With Distributor	1	2	U1056	48236
1.3, 135 RIC	Cpe		11/89→03/90			1	2	U1072	48309
1.3, 136	Cnv, Cpe		08/88→03/90			1	2	U1072	48309
Fabia (00→08)									
1.0	Hbk		03/00→06/00	Oval Connector	For Vehicles Without Distributor	1	4	U6020	48114
1.2	Est, Hbk	AZQ, BME	03/03→12/07	To Ch. No.: 6Y.7..646 965		3	4	U5002	48003
1.2	Hbk	AWY, BMD	02/03→12/07			3	4	U5006	48015
1.4	Est	AME, AQW, ATZ	02/01→04/04	Oval Connector	For Vehicles Without Distributor	1	4	U6020	48114
1.4	Est	AUA, BBY	02/01→08/03	To Ch. No.: 6Y-2-535494	For Vehicles Without Distributor	1	4	U2003	48010
1.4	Est	AUB, BBZ	02/01→08/03	To Ch. No.: 6Y-2-535494	For Vehicles Without Distributor	1	4	U2003	48010
1.4	Est	BBY, BKY	05/02→08/07	From Ch. No.: 6Y-2-535495		4	4	U5002	48003
1.4	Est	BBZ	05/02→12/07	From Ch. No.: 6Y-2-535495		4	4	U5002	48003
1.4	Est		07/07→08/08			4	4	U5002	48003
1.4	Hbk	AME, AQW, ATZ	03/00→04/04	Oval Connector	For Vehicles Without Distributor	1	4	U6020	48114
1.4	Hbk	AUA, BBY	11/00→08/03	To Ch. No.: 6Y-2-535494	For Vehicles Without Distributor	1	4	U2003	48010
1.4	Hbk	AUB, BBZ	03/00→08/03	To Ch. No.: 6Y-2-535494	For Vehicles Without Distributor	1	4	U2003	48010
1.4	Hbk	BBY, BKY	05/02→04/07	From Ch. No.: 6Y-2-535495		4	4	U5002	48003
1.4	Hbk	BBZ	05/02→04/07	From Ch. No.: 6Y-2-535495		4	4	U5002	48003
1.4	Sal	AUA, BBY	07/01→08/03	To Ch. No.: 6Y-2-535494	For Vehicles Without Distributor	1	4	U2003	48010
1.4	Sal	AUB, BBZ	07/01→08/03	To Ch. No.: 6Y-2-535494	For Vehicles Without Distributor	1	4	U2003	48010
1.4	Sal	BBY, BKY	05/02→12/06	From Ch. No.: 6Y-2-535495		4	4	U5002	48003
1.4	Sal	BBZ	05/02→12/06	From Ch. No.: 6Y-2-535495		4	4	U5002	48003
2.0	Est	AZL	02/01→12/07		For Vehicles Without Distributor	1	4	U2003	48010
2.0	Hbk	AQY, AZL	11/00→12/07		For Vehicles Without Distributor	1	4	U2003	48010
Fabia (07→10)									
1.2	Est	BZG, CEVA, CGPA, CHTA	02/08→08/10	To Ch. No.: 5J-8A500601, 5J-8B502695, 5J-83147326		3	4	U5002	48003
1.2	Hbk	BZG, CEVA, CGPA, CHTA	05/07→08/10			3	4	U5002	48003
1.2	Hbk		05/07→08/10			3	4	U5006	48015
1.4	Est	BXW, CGGB	02/08→08/10	To Ch. No.: 5J-8A500601, 5J-8B502695, 5J-83147326		4	4	U5002	48003
1.4	Hbk	BXW, CGGB	05/07→08/10	To Ch. No.: 5J-8A500601, 5J-8B502695, 5J-83147326		4	4	U5002	48003
1.4, Scout	Est	BXW, CGGB	04/09→08/10	To Ch. No.: 5J-8A500601, 5J-8B502695, 5J-83147326		4	4	U5002	48003
1.6	Est	BTS, CFNA	02/08→08/10	To Ch. No.: 5J-8A500601, 5J-8B502695, 5J-83147326		4	4	U5002	48003
1.6	Hbk	BTS, CFNA	05/07→08/10	To Ch. No.: 5J-8A500601, 5J-8B502695, 5J-83147326		4	4	U5002	48003
Fabia (10→)									
1.2	Est	BZG, CEVA, CGPA, CHTA	01/10→	To Ch. No.: 5J-8A500601, 5J-8B502695, 5J-83147326		3	4	U5002	48003
1.2	Hbk	BBM, CHFA	01/10→			3	4	U5006	48015
1.2	Hbk	BZG, CEVA, CGPA, CHTA	01/10→			3	4	U5002	48003
1.2, Scout TSI 85	Est	CBZA	03/10→		For Vehicles Without Distributor	1	4	U2003	48010
1.2, TSI 85	Est, Hbk	CBZA	03/10→		For Vehicles Without Distributor	1	4	U2003	48010
1.2, TSI 105	Est, Hbk	CBZB	03/10→		For Vehicles Without Distributor	1	4	U2003	48010
1.4, vRS	Est, Hbk	CAVE	06/10→			4	4	U5002	48003
Favorit (89→96)									
1.3	Est, Hbk	781.135E	01/93→06/93			1	2	U1072	48309
1.3	Est, Hbk	781.135E	07/93→06/94		Incl. Control Unit, For Vehicles With Distributor	1	3	U1001	48000

LITRE / MODEL	BODY	ENGINE TYPE	DATE	ADDITIONAL INFORMATION	FITMENT INFORMATION	NO. OF COILS	NO. OF PINS	PART NO.	STOCK NO.
SKODA (continued)									
Favorit (89→96)									
1.3, 135	Van	781.135	07/93→12/94		Incl. Control Unit, For Vehicles With Distributor	1	3	U1001	48000
1.3, 135	Van	781.135	12/91→06/93			1	2	U1072	48309
1.3, 136	Est	OHC	08/91→12/92			1	2	U1072	48309
1.3, 136	Hbk	136L	10/90→12/92			1	2	U1072	48309
1.3, 136	Van	OHC	07/93→12/94		Incl. Control Unit, For Vehicles With Distributor	1	3	U1001	48000
1.3, 136	Van	OHC	08/91→06/93			1	2	U1072	48309
1.3, E	Est	136B	01/94→06/95		Incl. Control Unit, For Vehicles With Distributor	1	3	U1001	48000
1.3, E	Hbk	136B	01/94→09/94		Incl. Control Unit, For Vehicles With Distributor	1	3	U1001	48000
Favorit Forman (89→96)									
1.3		781.135	07/93→12/94		Incl. Control Unit, For Vehicles With Distributor	1	3	U1001	48000
1.3		781.135	12/92→06/93			1	2	U1072	48309
Felicia (95→01)									
1.3	Est	136B	04/96→07/96		Incl. Control Unit, For Vehicles With Distributor	1	3	U1001	48000
1.3	Est	AMH	05/98→06/01	Angular Connector	For Vehicles Without Distributor	1	4	U6033	48234
1.3	Est, Hbk	AMH	08/96→03/98	Angular Connector	For Vehicles Without Distributor	1	4	U6033	48234
1.3	Hbk	135B	05/95→03/98		Incl. Control Unit, For Vehicles With Distributor	1	3	U1001	48000
1.3	Hbk	136B	05/95→07/96		Incl. Control Unit, For Vehicles With Distributor	1	3	U1001	48000
1.3	Hbk	AMG	05/95→06/01	Angular Connector	For Vehicles Without Distributor	1	4	U6033	48234
1.3	Hbk	AMH	04/98→06/01	Angular Connector	For Vehicles Without Distributor	1	4	U6033	48234
1.6	Est	AEE	06/96→12/00		Incl. Control Unit, For Vehicles With Distributor	1	3	U1001	48000
1.6	Hbk	AEE	04/98→12/00		Incl. Control Unit, For Vehicles With Distributor	1	3	U1001	48000
1.6	Hbk	AEE, EA111	06/96→03/98		Incl. Control Unit, For Vehicles With Distributor	1	3	U1001	48000
Octavia (98→00)									
1.6	Est	AEE	09/98→10/00		Incl. Control Unit, For Vehicles With Distributor	1	3	U1001	48000
1.6	Est	AEH, AKL	09/98→10/00		For Vehicles Without Distributor	1	4	U2003	48010
1.6	Hbk	AEE	06/98→10/00		Incl. Control Unit, For Vehicles With Distributor	1	3	U1001	48000
1.6	Hbk	AEH, AKL, AVU, BFQ	06/98→10/00		For Vehicles Without Distributor	1	4	U2003	48010
1.8	Est	AGN	07/98→07/00		For Vehicles Without Distributor	1	4	U2003	48010
1.8	Hbk	AGN	06/98→07/00		For Vehicles Without Distributor	1	4	U2003	48010
1.8, Turbo	Est, Hbk	AGU	09/99→10/00			4	3	U5004	48008
1.8, Turbo	Est, Hbk	ARX, AUM	09/99→10/00			4	4	U5003	48005
1.8, Turbo	Est, Hbk	ARZ	09/99→10/00			4	4	U5022	48082
2.0	Est	AEG, APK, AQY, AZH	09/99→10/00		For Vehicles Without Distributor	1	4	U2003	48010
2.0	Est	AZJ	09/99→10/00			1	6	U2011	48038
2.0	Hbk	AEG, APK, AQY, AZH, AZJ	09/99→10/00		For Vehicles Without Distributor	1	4	U2003	48010
Octavia (00→05)									
1.4	Hbk	AXP, BCA	10/00→02/02	To Ch. No.: 1U 22624 898, 1U 28566 292	For Vehicles Without Distributor	1	4	U2003	48010
1.4	Hbk	BCA	03/02→04/04			4	4	U5002	48003
1.4	Hbk		10/00→09/01	Oval Connector	For Vehicles Without Distributor	1	4	U6020	48114
1.6	Est	AVU, BFQ	10/00→03/05		For Vehicles Without Distributor	1	4	U2003	48010
1.6	Hbk	AVU, BFQ	11/00→12/04		For Vehicles Without Distributor	1	4	U2003	48010
1.8	Est	AGU	10/00→03/05			4	3	U5004	48008
1.8	Est	ARX	05/01→03/05			4	4	U5003	48005
1.8	Est	ARX, AUM	10/00→03/05			4	4	U5003	48005
1.8	Est	ARZ	10/00→12/00			4	4	U5022	48082
1.8	Hbk	AGU	10/00→12/04			4	3	U5004	48008
1.8	Hbk	ARX	07/01→02/04			4	4	U5003	48005

LITRE / MODEL	BODY	ENGINE TYPE	DATE	ADDITIONAL INFORMATION	FITMENT INFORMATION	NO. OF COILS	NO. OF PINS	PART NO.	STOCK NO.
SKODA (continued)									
Octavia (00→05)									
1.8	Hbk	ARX, AUM	10/00→12/04			4	4	U5003	48005
1.8	Hbk	ARZ	10/00→12/04			4	4	U5022	48082
1.8, vRS	Est	AUQ	02/03→03/05			4	4	U5003	48005
1.8, vRS	Hbk	AUQ	06/01→12/04			4	4	U5003	48005
2.0	Est	AEG, APK, AQY, AZH	10/00→03/05		For Vehicles Without Distributor	1	4	U2003	48010
2.0	Est	AZJ	10/00→03/05			1	6	U2011	48038
2.0	Hbk	AEG, APK, AQY, AZH, AZJ	10/00→12/04		For Vehicles Without Distributor	1	4	U2003	48010
Octavia (04→13)									
1.2, TSI 105	Est, Hbk	CBZB	02/10→		For Vehicles Without Distributor	1	4	U2003	48010
1.4	Hbk	BCA	07/04→05/06	From Ch. No.: 1Z 4 000 001		4	4	U5002	48003
1.4	Hbk	BUD, CGGA	07/06→	To Ch. No.: 1Z 72292 336, 1Z 7A151 668, 1Z 78087 783		4	4	U5002	48003
1.4, TSI 122	Est, Hbk	CAXA	01/09→			4	4	U5002	48003
1.6	Est	BGU, BSE, BSF, CCSA, CMXA	02/05→07/06		For Vehicles Without Distributor	1	4	U2003	48010
1.6	Hbk	BGU, BSE, BSF, CCSA, CMXA	06/04→07/06		For Vehicles Without Distributor	1	4	U2003	48010
1.6, FSI	Est	BLF	02/05→10/08			4	4	U5002	48003
1.6, FSI	Hbk	BLF	07/04→10/08			4	4	U5002	48003
1.6, MPI	Est, Hbk		04/09→		For Vehicles Without Distributor	1	4	U2003	48010
1.8, Scout TSI 160	Est	CDAA	01/09→			4	4	U5015	48042
1.8, TSI 152	Est, Hbk		10/11→			4	4	U5015	48042
1.8, TSI 160	Est	CDAA	01/09→			4	4	U5015	48042
1.8, TSI 160	Est, Hbk	BZB, CDAA	07/07→			4	4	U5015	48042
2.0, FSI	Est	BLR, BLY, BVY, BVZ	02/05→04/09			4	4	U5015	48042
2.0, FSI	Est	BLX, BVX	03/05→04/09			4	4	U5015	48042
2.0, FSI	Hbk	BLR, BLY, BVY, BVZ	11/04→04/09			4	4	U5015	48042
2.0, Scout FSI	Est		02/07→04/09			4	4	U5015	48042
2.0, TFSI vRS	Est, Hbk	BWA, CCZA	12/05→			4	4	U5015	48042
Octavia (13→)									
1.2, TSI 105	Est, Hbk	CJZA	01/13→			4	4	U5153	48408
1.2, TSI 105		CBZB	01/13→		For Vehicles Without Distributor	1	4	U2003	48010
1.4, TSI 140	Est, Hbk	CPTA, CHPA	01/13→			4	4	U5153	48408
Pick Up (96→01)									
1.3		136B, 136M	06/97→06/98		Incl. Control Unit, For Vehicles With Distributor	1	3	U1001	48000
1.6		AEE	06/98→12/01		Incl. Control Unit, For Vehicles With Distributor	1	3	U1001	48000
Rapid (12→)									
1.2		CGPC	09/12→			3	4	U5002	48003
1.2, TSI 86		CBZA	09/12→		For Vehicles Without Distributor	1	4	U2003	48010
1.2, TSI 105		CBZB	09/12→		For Vehicles Without Distributor	1	4	U2003	48010
Roomster (06→10)									
1.2		BZG, CGPA	02/07→08/10			3	4	U5002	48003
1.4, FSi		BXW, CGGB	09/06→08/10	To Ch. No.: 5J-65009090		4	4	U5002	48003
1.4, Scout FSi		BXW, CGGB	02/07→08/10	To Ch. No.: 5J-65009090		4	4	U5002	48003
1.6		BTS, CFNA	09/06→08/10			4	4	U5002	48003
1.6, Scout		BTS, CFNA	02/07→08/10			4	4	U5002	48003
Roomster (10→)									
1.2		BZG, CGPA	01/10→			3	4	U5002	48003
1.2, Scout TSI 85		CBZA	03/10→		For Vehicles Without Distributor	1	4	U2003	48010
1.2, Scout TSI 105		CBZB	03/10→		For Vehicles Without Distributor	1	4	U2003	48010
1.2, TSI 85		CBZA	03/10→		For Vehicles Without Distributor	1	4	U2003	48010
1.2, TSI 105		CBZB	03/10→		For Vehicles Without Distributor	1	4	U2003	48010
Superb (02→08)									
1.8		AWT	04/02→03/08	To Ch. No.: 3U..3..043 319		4	4	U5003	48005
2.0		AZM	04/02→03/08		For Vehicles Without Distributor	1	4	U2003	48010
2.8		AMX	04/02→03/08			1	5	U2010	48037

LITRE / MODEL	BODY	ENGINE TYPE	DATE	ADDITIONAL INFORMATION	FITMENT INFORMATION	NO. OF COILS	NO. OF PINS	PART NO.	STOCK NO.
SKODA (continued)									
Superb (08→)									
1.4, TSI 125	Est	CAXC	01/10→			4	4	U5002	48003
1.4, TSI 125	Hbk	CAXC	09/08→			4	4	U5002	48003
1.8, TSI 152	Est, Hbk	CDAB	10/11→			4	4	U5015	48042
1.8, TSI 160	Est	CDA A	01/10→			4	4	U5015	48042
1.8, TSI 160	Hbk	BZB, CDA A	09/08→			4	4	U5015	48042
1.8, TSI 160	Hbk	CDA A	11/08→			4	4	U5015	48042
2.0, TFSI 200	Est, Hbk	CCZA	09/11→			4	4	U5015	48042
3.6	Est	CDVA	01/10→			6	4	U5020	48065
3.6	Hbk	CDVA	04/09→			6	4	U5020	48065
3.6	Hbk	CDVA	09/08→04/10			6	4	U5020	48065
Yeti (09→)									
1.2, TSI		CBZB	09/09→		For Vehicles Without Distributor	1	4	U2003	48010
1.4, TSI		CAXA	07/10→			4	4	U5002	48003
1.8, TSI 152		CDAB	10/11→			4	4	U5015	48042
1.8, TSI 160		CDA A	07/09→			4	4	U5015	48042

SMART									
City (99→04)									
0.6, Passion	Cnv	M160E6ALB03, M160.920	01/01→04/03			3	4	U3010	48085
0.6, Passion	Cpe	M160E6ALB03, M160.920	12/99→04/03			3	4	U3010	48085
0.6, Pulse	Cnv	M160E6ALB05, M160.920	04/01→04/03			3	4	U3010	48085
0.6, Pulse	Cpe	M160E6ALB03, M160.920	12/99→01/01			3	4	U3010	48085
0.6, Pulse	Cpe	M160E6ALB05, M160.920	01/01→04/03			3	4	U3010	48085
0.6, Pure	Cpe	M160E6ALB04, M160.920	12/99→04/03			3	4	U3010	48085
0.7, Brabus	Cnv	M160.910	07/03→01/04			3	4	U3010	48085
0.7, Brabus	Cpe	M160.910	03/03→01/04			3	4	U3010	48085
0.7, Passion	Cnv, Cpe	M160.910	03/03→01/04			3	4	U3010	48085
0.7, Pulse	Cnv, Cpe	M160.910	03/03→01/04			3	4	U3010	48085
0.7, Pure	Cpe	M160.910	03/03→01/04			3	4	U3010	48085
Forfour (04→07)									
1.0		M134.911	10/05→06/06			3	3	U5101	48317
1.1		M134.910	06/04→06/06			3	3	U5101	48317
1.3		M135.930	06/04→06/06			4	3	U5101	48317
1.5		M135.950	06/04→06/06			4	3	U5101	48317
1.5, Brabus		M122.950	05/05→06/06			4	3	U5101	48317
Fortwo (04→07)									
0.7, Brabus	Cnv, Cpe	M160.910	01/04→01/07			3	4	U3010	48085
0.7, Pure	Cpe	M160.910	01/04→01/07			3	4	U3010	48085
0.7, Pure/Pulse/Passion	Cnv, Cpe	M160.910	01/04→01/07			3	4	U3010	48085
Fortwo (07→12)									
1.0	Cnv, Cpe	M132.910	09/07→03/09			3	4	U3010	48085
1.0, Micro Hybrid Drive	Cnv, Cpe	M132.910	08/08→08/12			3	4	U3010	48085
1.0, Micro Hybrid Drive	Cpe	M132.910	08/08→06/10			3	4	U3010	48085
1.0, Turbo	Cnv, Cpe	M132.930	09/07→08/12			3	4	U3010	48085
Fortwo (12→)									
1.0, Micro Hybrid Drive	Cnv, Cpe	M132.910	02/12→			3	4	U3010	48085
1.0, Turbo	Cnv, Cpe	M132.930	02/12→			3	4	U3010	48085
Roadster (03→06)									
0.7	Cnv	M160.921	06/03→11/05			3	4	U3010	48085
0.7	Cpe	M160.922	06/03→11/05			3	4	U3010	48085
0.7, Brabus	Cnv, Cpe	M160.923	04/04→11/05			3	4	U3010	48085

SSANGYONG									
Korando									
2.3		M111.970	09/97→12/98			2	1	U4026	48018

LITRE / MODEL	BODY	ENGINE TYPE	DATE	ADDITIONAL INFORMATION	FITMENT INFORMATION	NO. OF COILS	NO. OF PINS	PART NO.	STOCK NO.
SSANGYONG (continued)									
Musso									
2.3		M111.970	08/97→12/98			3	1	U4026	48018
3.2, GX220		M104.992	08/96→12/98			3	1	U4026	48018
Rexton MK 1									
3.2, RX320		G32D	08/03→12/05			6	3	U3004	48024
3.2, RX320		G32D	08/03→12/05			3	1	U4026	48018

SUBARU									
Forester (97→00)									
2.0		EJ202	09/97→04/00	Oval Connector		1	4	U2055	48254
Forester (00→02)									
2.0		EJ202	04/00→09/02	Oval Connector		1	4	U2055	48254
Forester (02→05)									
2.0, X		EJ20	10/02→10/05	Oval Connector		1	4	U2055	48254
2.0, XT		EJ20	10/02→10/05	Oval Connector		1	4	U2055	48254
2.5, XT		EJ25	11/04→05/05	Oval Connector		1	4	U2055	48254
Forester (05→08)									
2.0		EJ204	09/05→12/08	Oval Connector		1	4	U2055	48254
2.5, SG		EJ255	05/05→12/08			4	3	U5319	49057
Forester (08→14)									
2.0		EJ204	04/08→03/14			4	3	U5319	49057
2.5, SG		EJ255	04/08→06/13			4	3	U5319	49057
Impreza (93→00)									
2.0	Hbk	EJ20	03/99→11/00	Oval Connector		1	4	U2055	48254
2.0	Hbk	EJ20	12/95→06/98			1	3	U2047	48202
2.0	Hbk, Sal	EJ20	03/99→11/00			1	3	U2047	48202
2.0	Sal	EJ201	12/95→03/99	Oval Connector		1	4	U2055	48254
2.0	Sal	EJ20E	12/95→03/99			1	3	U2047	48202
2.0, Turbo	Hbk	EJ20G	12/96→06/98			1	3	U2047	48202
2.0, Turbo	Sal	EJ20G	07/96→06/98			1	3	U2047	48202
Impreza (00→03)									
2.0	Hbk	EJ20	12/00→02/03	Oval Connector		1	4	U2055	48254
2.0, WRX	Hbk, Sal	EJ205	10/02→02/03			4	3	U5062	48227
2.0, WRX STi	Sal	EJ207	01/02→02/03			4	3	U5062	48227
Impreza (03→05)									
2.0, GX	Est	EJ20	02/03→11/05	Oval Connector		1	4	U2055	48254
2.0, WRX	Est, Sal	EJ205	02/03→11/05			4	3	U5062	48227
2.0, WRX STi	Sal	EJ207	02/03→11/05			4	3	U5062	48227
Impreza (05→07)									
2.0, R		EJ20, EJ204	11/05→12/07	Oval Connector		1	4	U2055	48254
2.5, WRX		EJ255, EJ257	11/05→12/07			4	3	U5319	49057
Impreza (07→12)									
1.5		EL154	09/07→03/12			4	3	U5319	49057
2.0		EJ204	09/07→10/12			4	3	U5319	49057
2.0, R		EJ204	09/07→03/12			4	3	U5319	49057
2.5, WRX		EJ255, EJ257	05/09→04/11			4	3	U5319	49057
Legacy (94→99)									
2.0	Est	EJ20	09/94→11/98			1	3	U2047	48202
2.0	Sal	EJ20	09/94→10/98			1	3	U2047	48202
2.2	Est	EJ22EMPI	04/94→01/98			1	3	U2047	48202
2.2	Est	EJ22EMPI	04/94→01/98			1	3	U2056	48255
2.2	Sal	EJ22EMPI	09/94→01/98			1	3	U2047	48202
2.2	Sal	EJ22EMPI	09/94→01/98			1	3	U2056	48255
2.5	Est	EJ25D	09/96→11/98			1	3	U2047	48202
2.5	Sal	EJ25D	09/96→12/98			1	3	U2047	48202

LITRE / MODEL	BODY	ENGINE TYPE	DATE	ADDITIONAL INFORMATION	FITMENT INFORMATION	NO. OF COILS	NO. OF PINS	PART NO.	STOCK NO.
SUBARU (continued)									
Legacy (98→03)									
2.0	Est, Sal	EJ20	09/99→08/03	Oval Connector		1	4	U2055	48254
2.5	Est	EJ25	12/98→08/03	Oval Connector		1	4	U2055	48254
2.5	Sal	EJ25	01/00→08/03	Oval Connector		1	4	U2055	48254
2.5	Sal	EJ25	04/99→12/99			1	3	U2056	48255
Legacy (03→10)									
2.0	Est, Sal	EJ202	03/04→09/05			4	3	U5319	49057
2.5	Est, Sal	EJ25	11/03→10/05	Oval Connector		1	4	U2055	48254
2.5	Sal	EJ25	11/03→10/05			1	3	U2056	48255
2.5, Outback	Est	EJ251	09/08→09/09	Oval Connector		1	4	U2055	48254
2.5, Outback	Est	EJ25D	11/03→06/08	Oval Connector		1	4	U2055	48254

SUZUKI									
Alto (82→92)									
0.8		F8B	06/82→07/92		For Vehicles With Distributor	1	2	U1056	48236
Alto (03→07)									
1.1		F10D, F10DN	01/03→03/07		For Vehicles Without Distributor	2	3	U4008	48157
Baleno (95→02)									
1.6	Est	G16B	08/96→08/99		For Vehicles Without Distributor	2	3	U4008	48157
1.6	Hbk	G16B	07/95→12/00		For Vehicles Without Distributor	2	3	U4008	48157
1.6	Sal	G16B	07/95→12/00	From Ch. No.: -160001	For Vehicles Without Distributor	2	3	U4008	48157
1.8	Est	J18A	06/99→01/02			4	3	U5092	48281
1.8	Est	J18A	06/99→01/02			4	2	U5095	48285
1.8	Hbk	J18A	08/00→01/02			4	3	U5092	48281
1.8	Hbk	J18A	08/00→01/02			4	2	U5095	48285
1.8	Sal	J18A	08/96→12/97			4	3	U5092	48281
1.8	Sal	J18A	08/96→12/97			4	2	U5095	48285
Carry (90→06)									
1.3		G13BB	03/00→12/06		For Vehicles Without Distributor	2	3	U4008	48157
Grand Vitara (98→05)									
1.6		G16B	01/01→11/05			2	3	U4010	48183
2.0		J20A	05/99→11/05			4	3	U5092	48281
2.5		H25A	04/98→01/02			6	3	U5092	48281
2.5		H25A	08/04→11/05			6	3	U5092	48281
2.7		H27A	01/04→11/05			6	3	U5092	48281
Grand Vitara (05→)									
1.6		M16A	10/05→		For Vehicles Without Distributor	2	3	U4008	48157
2.0		J20A	10/05→04/10			4	3	U5092	48281
2.0		J20A	10/05→04/10			4	2	U5095	48285
Ignis (00→08)									
1.3		M13A	12/00→08/08		For Vehicles Without Distributor	2	3	U4008	48157
1.5		M15A	09/03→06/08		For Vehicles Without Distributor	2	3	U4008	48157
1.5, 4GRIP		M15A	09/03→06/08		For Vehicles Without Distributor	2	3	U4008	48157
1.5, Sport		M15A	12/03→08/06		For Vehicles Without Distributor	2	3	U4008	48157
Jimny (98→)									
1.3, Hard Top		G13BB	10/98→02/01			2	3	U4010	48183
1.3, Hard Top		M13A	02/01→02/05		For Vehicles Without Distributor	2	3	U4008	48157
1.3, Hard Top		M13A	02/01→02/05			2	3	U4010	48183
1.3, Hard Top		M13A	08/05→		For Vehicles Without Distributor	2	3	U4008	48157
1.3, Hard Top		M13A	08/05→			2	3	U4010	48183
1.3, Soft Top		G13BB	02/00→04/03			2	3	U4010	48183
Liana (01→08)									
1.6	Hbk	M16A	07/01→12/07		For Vehicles Without Distributor	2	3	U4008	48157
1.6	Sal	M16A	08/02→03/08		For Vehicles Without Distributor	2	3	U4008	48157
SJ410 (82→91)									
1.0	ATV/SUV	F10A	09/82→12/88		For Vehicles With Distributor	1	2	U1056	48236
1.0	Van	F10A	01/85→12/88		For Vehicles With Distributor	1	2	U1056	48236

LITRE / MODEL	BODY	ENGINE TYPE	DATE	ADDITIONAL INFORMATION	FITMENT INFORMATION	NO. OF COILS	NO. OF PINS	PART NO.	STOCK NO.
SUZUKI (continued)									
SJ413 (85→97)									
1.3	ATV/SUV	G13A	11/88→04/92			1	2	U1038	48180
1.3	ATV/SUV	G13BA	01/95→07/97			1	2	U1038	48180
1.3	Van	G13A	11/88→12/92			1	2	U1038	48180
Super Carry (86→98)									
1.0		F10A	03/86→12/98		For Vehicles With Distributor	1	2	U1056	48236
Swift (05→11)									
1.3		M13A	04/05→03/11		For Vehicles Without Distributor	2	3	U4008	48157
1.5		M15A	04/05→03/11		For Vehicles Without Distributor	2	3	U4008	48157
1.6, Sport		M16A	10/06→12/11		For Vehicles Without Distributor	2	3	U4008	48157
SX4 (06→)									
1.5		M15A	06/09→03/11		For Vehicles Without Distributor	2	3	U4008	48157
1.6		M16A	06/06→08/10		For Vehicles Without Distributor	2	3	U4008	48157
Vitara (88→02)									
1.6	Van		12/93→12/96			1	2	U1040	48182
1.6, JLX	ATV/SUV		10/88→01/97			1	2	U1040	48182
1.6, JLX SE	ATV/SUV		09/91→12/98			1	2	U1038	48180
1.6, JLX SE	ATV/SUV		12/89→07/97			1	2	U1040	48182
1.6, JX (3-Door)	ATV/SUV		06/99→12/00			1	2	U1040	48182
1.6, JX (3-Door)	ATV/SUV		10/93→12/95			1	2	U1040	48182
1.6, JX (5-Door)	ATV/SUV		10/93→12/00			1	2	U1040	48182
1.6, JX Sport	ATV/SUV		08/96→12/99			1	2	U1040	48182
1.6, Sport (3-Door)	ATV/SUV		05/93→12/94			1	2	U1040	48182
1.6, Sport 2 (3-Door)	ATV/SUV		01/95→12/96			1	2	U1040	48182
2.0	ATV/SUV	H20A	07/95→03/98	From Ch. No.: 150001		6	3	U5092	48281
2.0	ATV/SUV	H20A	07/95→03/98	To Ch. No.: 150000		6	2	U5095	48285
Wagon R Wagon R+ (00→08)									
1.3		G13BB	05/00→12/03		For Vehicles Without Distributor	2	3	U4008	48157
1.3		M13A	10/03→08/06		For Vehicles Without Distributor	2	3	U4008	48157

TALBOT									
Alpine									
1.3			01/80→12/83		Electronic Ignition (EI), With Distributor	1	2	U1068	48305
1.5			01/80→09/82		Electronic Ignition (EI), With Distributor	1	2	U1068	48305
1.6			03/82→09/85		Electronic Ignition (EI), With Distributor	1	2	U1068	48305
Avenger									
1.3	Est, Sal		01/80→07/81		For Vehicles With Distributor	1	2	U1068	48305
1.6	Est, Sal		01/80→07/81		For Vehicles With Distributor	1	2	U1068	48305
Express (85→90)									
1.8		XM7T	10/86→06/90		For Vehicles With Distributor	1	2	U1076	48339
2.0		XN1TA	10/86→06/90		For Vehicles With Distributor	1	2	U1076	48339
Express (90→94)									
2.0		XN1TA	06/90→06/94		For Vehicles With Distributor	1	2	U1076	48339
Horizon									
1.1			01/80→09/84		For Vehicles With Distributor	1	2	U1068	48305
Matra Rancho									
1.5		X3Y2	01/80→09/80		For Vehicles With Distributor	1	2	U1065	48302
1.5		X3Y2	10/80→07/84		Electronic Ignition (EI), With Distributor	1	2	U1068	48305
Rapier									
1.6			10/84→07/86		Electronic Ignition (EI), With Distributor	1	2	U1068	48305
Samba									
1.0	Hbk		03/82→05/86		Electronic Ignition (EI), With Distributor	1	2	U1076	48339
1.1	Hbk	XW7	03/82→04/86		For Vehicles With Distributor	1	2	U1076	48339
1.4	Cnv		10/82→09/85		Electronic Ignition (EI), With Distributor	1	2	U1076	48339
1.4	Hbk		03/82→10/83		Electronic Ignition (EI), With Distributor	1	2	U1076	48339

LITRE / MODEL	BODY	ENGINE TYPE	DATE	ADDITIONAL INFORMATION	FITMENT INFORMATION	NO. OF COILS	NO. OF PINS	PART NO.	STOCK NO.
TALBOT (continued)									
Solara									
1.3			05/80→09/84		Electronic Ignition (EI), With Distributor	1	2	U1068	48305
1.6		J1B	09/81→09/85		Electronic Ignition (EI), With Distributor	1	2	U1068	48305
Sunbeam									
1.0			01/80→12/82		Electronic Ignition (EI), With Distributor	1	2	U1068	48305
1.3			01/80→04/81		Electronic Ignition (EI), With Distributor	1	2	U1068	48305
1.6, GL			01/80→04/81		Electronic Ignition (EI), With Distributor	1	2	U1068	48305
1.6, GLS		TB	01/80→04/81		Electronic Ignition (EI), With Distributor	1	2	U1068	48305
1.6, Ti		TB	01/80→12/82		Electronic Ignition (EI), With Distributor	1	2	U1068	48305
2.2, Lotus			01/80→12/82		Electronic Ignition (EI), With Distributor	1	2	U1068	48305

TOYOTA									
4-Runner VZN130									
3.0		3VZ-E	09/91→03/95		For Vehicles With Distributor	1	2	U1018	48105
Auris (06→13)									
1.33, Dual-VVTi		1NR-FE	12/08→			4	4	U5145	48395
1.4		4ZZ-FE	03/07→08/09			4	4	U5029	48107
1.6		1ZR-FAE	02/09→			4	4	U5145	48395
1.6, VVTi		1ZR-FE	12/06→			4	4	U5145	48395
1.8		2ZR-FAE	02/09→			4	4	U5145	48395
1.8		2ZR-FAE	02/09→			4	4	U5145	48395
1.8, 4WD		2ZR-FAE	02/09→			4	4	U5145	48395
Avensis (97→03)									
1.6	Hbk, Sal	4A-FE	11/97→10/00		For Vehicles With Distributor	1	2	U1013	48093
1.6	Hbk, Sal	3ZZ-FE	10/00→02/03			4	4	U5029	48107
1.8	Est, Hbk, Sal	1ZZ-FE	10/00→02/03			4	4	U5029	48107
2.0	Est, Hbk, Sal	1AZ-FSE	10/00→02/03			4	4	U5090	48278
2.0	Est, Hbk, Sal	3S-FE	11/97→10/00		For Vehicles Without Distributor	2	4	U3018	48280
Avensis (03→09)									
1.8	Est, Hbk, Sal	1ZZ-FE	04/03→11/08			4	4	U5029	48107
2.0	Est, Hbk, Sal	1AZ-FSE	04/03→11/08			4	4	U5090	48278
2.4	Hbk, Sal	2AZ-FSE	10/03→09/04			4	4	U5090	48278
Avensis (09→)									
1.6		1ZR-FAE	06/09→			4	4	U5145	48395
1.6		1ZR-FAE	06/09→			4	4	U5145	48395
1.8		2ZR-FAE	01/09→			4	4	U5145	48395
1.8		2ZR-FAE	05/09→			4	4	U5145	48395
2.0		3ZR-FAE	01/09→			4	4	U5145	48395
2.0		3ZR-FAE	01/09→			4	4	U5145	48395
Avensis Verso (01→05)									
2.0		1AZ-FE	08/01→12/05			4	4	U5052	48184
Aygo (05→)									
1.0		1KR-FE	07/05→09/12			3	4	U5029	48107
Camry									
2.0	Est, Sal	3S-FE	01/87→05/91		For Vehicles With Distributor	1	2	U1013	48093
2.2	Est	5S-FE	03/92→09/95		For Vehicles With Distributor	1	2	U1014	48094
2.2	Sal	5S-FE	09/91→12/95		For Vehicles With Distributor	1	2	U1014	48094
2.2		5S-FE	11/96→11/01		For Cyl.: 1-4, 2-3, Without Distributor	2	4	U3018	48280
2.4		2AZ-FE	11/01→03/04			4	4	U5052	48184
2.5	Sal	2VZFE	03/89→12/91		For Vehicles With Distributor	1	2	U1091	48363
3.0		1MZ-FE	11/96→11/01			3	2	U4024	48326
3.0		1MZ-FE	11/01→03/04			6	4	U5100	48297

LITRE / MODEL	BODY	ENGINE TYPE	DATE	ADDITIONAL INFORMATION	FITMENT INFORMATION	NO. OF COILS	NO. OF PINS	PART NO.	STOCK NO.
TOYOTA (continued)									
Carina E									
1.6, Automatic	Hbk	4A-FE	12/93→03/96		For Vehicles With Distributor	1	2	U1043	48188
1.6, Automatic	Sal	4A-FE	12/94→03/96		For Vehicles With Distributor	1	2	U1043	48188
1.6, Manual	Est	4A-FE	01/93→06/95		For Vehicles With Distributor	1	2	U1013	48093
1.6, Manual	Est	4A-FE	01/93→06/95		For Vehicles With Distributor	1	2	U1043	48188
1.6, Manual	Hbk	4A-FE	05/92→04/97		For Vehicles With Distributor	1	2	U1013	48093
1.6, Manual	Hbk	4A-FE	05/92→04/97		For Vehicles With Distributor	1	2	U1043	48188
1.6, Manual	Sal	4A-FE	01/93→04/97		For Vehicles With Distributor	1	2	U1013	48093
1.6, Manual	Sal	4A-FE	01/93→04/97		For Vehicles With Distributor	1	2	U1043	48188
1.8	Est	7A-FE	06/95→03/96		For Vehicles With Distributor	1	2	U1043	48188
1.8	Est, Hbk, Sal	7A-FE	03/96→09/97		For Vehicles With Distributor	1	2	U1043	48188
1.8	Hbk, Sal	7A-FE	03/95→03/96		For Vehicles With Distributor	1	2	U1043	48188
2.0	Est, Sal	3S-FE	01/93→09/97		For Vehicles With Distributor	1	2	U1014	48094
2.0	Hbk	3S-FE	05/92→09/97		For Vehicles With Distributor	1	2	U1014	48094
2.0, GTi	Hbk, Sal	3S-GE	05/92→02/94		For Vehicles With Distributor	1	2	U1043	48188
2.0, GTi	Sal	3S-GE	06/94→01/96		For Vehicles With Distributor	1	2	U1043	48188
Celica AT200									
1.8		7A-FE	07/95→10/99		For Vehicles With Distributor	1	2	U1013	48093
Celica RA61									
2.0	Cpe	21R-U	02/82→11/85		For Vehicles With Distributor	1	2	U1056	48236
2.0	Hbk	21R-C	02/82→08/85		For Vehicles With Distributor	1	2	U1056	48236
Celica ST165									
2.0, GT-Four		3S-GTE	03/88→02/90		For Vehicles With Distributor	1	2	U1043	48188
Celica ST182									
2.0		3S-GE	02/90→01/94		For Vehicles With Distributor	1	2	U1018	48105
2.0		3S-GE	02/90→01/94	With Bracket		1	2	U1045	48198
Celica ST185									
2.0, GT-Four		3S-GTE	02/90→12/92		For Vehicles With Distributor	1	2	U1043	48188
2.0, GT-Four 'Carlos Sainz'		3S-GTE	03/92→12/93		For Vehicles With Distributor	1	2	U1043	48188
Celica ST205									
2.0, GT-Four		3S-GTE	05/94→10/96		For Vehicles With Distributor	1	2	U1043	48188
Celica ZTZ230									
1.8		1ZZ-FE	11/99→03/06			4	4	U5029	48107
Celica ZTZ231									
1.8		2ZZ-GE	12/01→03/06			4	4	U5068	48240
Corolla (E80) EE80									
1.3	Hbk	2E-L	08/85→08/87		For Vehicles With Distributor	1	2	U1056	48236
1.3	Sal	2E-L, 2E-LC	03/85→08/87		For Vehicles With Distributor	1	2	U1056	48236
Corolla (E90) AE92									
1.6		4A-F	08/87→04/92		For Vehicles With Distributor	1	2	U1013	48093
Corolla (E90) EE90									
1.3	Est, Hbk		08/87→12/92		For Vehicles With Distributor	1	2	U1013	48093
1.3	Sal	2E, 2E-E	08/87→12/92		For Vehicles With Distributor	1	2	U1013	48093
Corolla (E100) AE101									
1.6	Est, Hbk	4A-FE	08/92→04/97		For Vehicles With Distributor	1	2	U1013	48093
1.6	Sal	4A-FE	08/92→04/97		For Vehicles With Distributor	1	2	U1013	48093
Corolla (E100) AE102									
1.8		7A-FE	03/93→03/95		For Vehicles With Distributor	1	2	U1013	48093
Corolla (E100) EE101									
1.3	Est, Hbk, Sal	4E-FE	08/92→07/95		For Vehicles With Distributor	1	2	U1013	48093
1.3	Est, Hbk, Sal	4E-FE	08/92→07/95		For Vehicles Without Distributor	2	4	U3018	48280
1.3, Automatic	Hbk	4E-FE	09/95→04/97		For Vehicles With Distributor	1	2	U1013	48093
1.3, Automatic	Hbk	4E-FE	09/95→04/97		For Vehicles Without Distributor	2	4	U3018	48280
1.3, Manual	Hbk	4E-FE	07/95→04/97		For Vehicles With Distributor	1	2	U1013	48093
1.3, Manual	Hbk	4E-FE	07/95→04/97		For Vehicles Without Distributor	2	4	U3018	48280

LITRE / MODEL	BODY	ENGINE TYPE	DATE	ADDITIONAL INFORMATION	FITMENT INFORMATION	NO. OF COILS	NO. OF PINS	PART NO.	STOCK NO.
TOYOTA (continued)									
Corolla (E110) AE111									
1.6, Automatic	Est	4A-FE	10/98→02/00		For Vehicles With Distributor	1	2	U1013	48093
1.6, Automatic	Hbk, Sal	4A-FE	06/97→02/00		For Vehicles With Distributor	1	2	U1013	48093
1.6, Manual	Est	4A-FE	10/98→02/00		For Vehicles With Distributor	1	2	U1013	48093
1.6, Manual	Hbk, Sal	4A-FE	06/97→02/00		For Vehicles With Distributor	1	2	U1013	48093
Corolla (E110) EE111									
1.3	Est, Hbk	4E-FE	06/97→02/00		For Vehicles With Distributor	1	2	U1013	48093
1.3	Est, Hbk	4E-FE	06/97→02/00		For Vehicles Without Distributor	2	4	U3018	48280
1.3	Sal	4E-FE	06/97→10/98		For Vehicles With Distributor	1	2	U1013	48093
1.3	Sal	4E-FE	06/97→10/98		For Vehicles Without Distributor	2	4	U3018	48280
Corolla (E110) ZZE111									
1.4	Est, Hbk	4ZZ-FE	02/00→01/02			4	4	U5029	48107
1.4	Est, Hbk	4ZZ-FE	02/00→01/02			4	3	U5030	48116
Corolla (E110) ZZE112									
1.6			02/00→03/02			4	4	U5029	48107
Corolla (E120) ZZE121									
1.4	Hbk	4ZZ-FE	01/02→12/06			4	4	U5029	48107
1.4	Hbk	4ZZ-FE	01/02→12/06			4	3	U5030	48116
1.4	Sal	4ZZ-FE	09/02→07/07			4	4	U5029	48107
1.4	Sal	4ZZ-FE	09/02→07/07			4	3	U5030	48116
Corolla (E120) ZZE122									
1.6	Est	3ZZ-FE	01/02→02/07			4	4	U5029	48107
1.6	Hbk	3ZZ-FE	01/02→12/06			4	4	U5029	48107
1.6	Sal	3ZZ-FE	09/02→07/07			4	4	U5029	48107
Corolla (E120) ZZE124									
1.8		2ZZ-GE	12/01→07/06			4	4	U5068	48240
1.8		2ZZ-GE	01/02→07/06			4	4	U5068	48240
Corolla Verso (01→04)									
1.6		3ZZ-FE	01/02→05/04			4	4	U5029	48107
1.8		1ZZ-FE	01/02→05/04			4	4	U5029	48107
Corolla Verso (04→09)									
1.6		3ZZ-FE	05/04→03/09			4	4	U5029	48107
1.8		1ZZ-FE	05/04→03/09			4	4	U5029	48107
Hi-Ace (88→94)									
2.0, 1RZ			01/88→07/94		For Vehicles With Distributor	1	2	U1013	48093
Hi-Ace (01→06)									
2.7		3RZ-FE	11/01→12/03		For Vehicles Without Distributor	2	4	U3018	48280
2.7		3RZ-FE	11/01→12/03			4	4	U5086	48273
Hi-Ace Power Van (96→01)									
2.4		2RZ-E	01/96→01/98		For Vehicles With Distributor	1	2	U1013	48093
2.7		3RZ-FE	04/98→12/01		For Vehicles Without Distributor	2	4	U3018	48280
2.7		3RZ-FE	04/98→12/01			4	4	U5086	48273
iQ (09→)									
1.0		1KR-FE	01/09→			3	4	U5027	48095
Landcruiser									
4.0		1GR-FE	03/03→10/08			6	4	U5090	48278
4.5		1FZ-FE	04/95→05/97		For Vehicles With Distributor	1	2	U1043	48188
4.5		1FZ-FE	02/97→12/97		For Vehicles With Distributor	1	2	U1043	48188
4.7		2UZ-FE	04/98→07/02			8	4	U5065	48235
MR2									
1.8		1ZZ-FE	04/00→09/05			4	4	U5029	48107
2.0		3S-FE	04/90→12/91		For Vehicles With Distributor	1	2	U1091	48363
2.0		3S-FE	12/92→04/00		For Vehicles With Distributor	1	2	U1018	48105
2.0, GT		3S-GE	04/90→12/91		For Vehicles With Distributor	1	2	U1091	48363
2.0, GT		3S-GE	12/92→04/00		For Vehicles With Distributor	1	2	U1018	48105
2.0, GT T-Bar		3S-GE	04/90→12/91		For Vehicles With Distributor	1	2	U1091	48363
2.0, GT T-Bar		3S-GE	12/92→04/00		For Vehicles With Distributor	1	2	U1018	48105

LITRE / MODEL	BODY	ENGINE TYPE	DATE	ADDITIONAL INFORMATION	FITMENT INFORMATION	NO. OF COILS	NO. OF PINS	PART NO.	STOCK NO.
TOYOTA (continued)									
Paseo									
1.5		5E-FE	03/96→07/99		For Vehicles With Distributor	1	2	U1014	48094
Picnic									
2.0		3S-FE	01/97→09/01		For Vehicles Without Distributor	2	4	U3018	48280
Previa									
2.4		2AZ-FE	08/00→12/05			4	4	U5052	48184
Prius									
1.5		1NZ-FXE	10/00→11/03			4	4	U5027	48095
1.5		1NZ-FXE	01/04→03/09			4	4	U5027	48095
RAV-4 (94→00)									
2.0		1AZ-FE	02/00→08/00			4	4	U5052	48184
2.0		3S-FE	06/94→08/96		For Vehicles With Distributor	1	2	U1014	48094
2.0		3S-FE	06/94→08/96		For Vehicles With Distributor	1	2	U1043	48188
2.0		3S-FE	08/96→10/96		For Cyl.: 1-4, 2-3, Without Distributor	2	4	U3018	48280
2.0		3S-FE	12/97→06/00		For Cyl.: 1-4, 2-3, Without Distributor	2	4	U3018	48280
RAV-4 (00→06)									
1.8		1ZZ-FE	02/01→12/03			4	4	U5029	48107
2.0		1AZ-FE	08/00→03/06			4	4	U5052	48184
RAV-4 (06→13)									
2.0		1AZ-FE	03/06→12/09			4	4	U5052	48184
2.0		3ZR-FAE	06/09→04/11			4	4	U5145	48395
2.0, 4WD		3ZR-FAE	06/09→12/13			4	4	U5145	48395
Starlet (90→96)									
1.3		2E-E	10/93→03/96		For Vehicles With Distributor	1	2	U1013	48093
Starlet (96→99)									
1.3		4E-FE	04/96→03/99		For Vehicles With Distributor	1	2	U1013	48093
Tercel									
1.5		3A	03/83→10/86		For Vehicles With Distributor	1	2	U1056	48236
1.5		3A	03/83→10/86		For Vehicles With Distributor	1	2	U1068	48305
Verso (09→)									
1.6		2ZR-FAE	03/09→			4	4	U5145	48395
1.8		2ZR-FE	03/07→			4	4	U5145	48395
Yaris (99→06)									
1.0		1SZ-FE	04/99→09/05			4	4	U5027	48095
1.3		2NZ-FE	05/03→09/05			4	4	U5027	48095
1.5, T Sport		1NZ-FE	04/01→09/05			4	4	U5027	48095
Yaris (05→12)									
1.0		1KR-FE	01/06→03/12			3	4	U5029	48107
1.3		2NZ-FE	11/05→12/09			4	4	U5027	48095
1.8, VVTi		1ZR-FAE	01/07→			4	4	U5145	48395
1.33		1NR-FE	03/09→03/12			4	4	U5027	48095
Yaris (11→)									
1.0		1KR-FE	09/11→			3	4	U5029	48107
Yaris Verso (00→06)									
1.3		2NZ-FE	01/00→09/05			4	4	U5027	48095

TRIUMPH									
2000 MK 1									
2.0	Est, Sal		01/68→12/69		For Vehicles With Distributor	1	2	U1079	48342
2000 MK 2									
2.0			03/72→12/75		Conventional Coil Ignition (CI), With Distributor	1	2	U1056	48236
2.0, TC		20TC	05/75→12/77		Conventional Coil Ignition (CI), With Distributor	1	2	U1056	48236
2500 MK 1									
2.5PI	Est	25PI	03/69→12/69		For Vehicles With Distributor	1	2	U1079	48342

LITRE / MODEL	BODY	ENGINE TYPE	DATE	ADDITIONAL INFORMATION	FITMENT INFORMATION	NO. OF COILS	NO. OF PINS	PART NO.	STOCK NO.
TRIUMPH (continued)									
2500 MK 1									
2.5PI	Sal	25PI	10/68→12/69		For Vehicles With Distributor	1	2	U1079	48342
2500 MK 2									
2.5, 2500TC	Sal		05/74→04/75		Conventional Coil Ignition (CI), With Distributor	1	2	U1056	48236
2.5, 2500TC/2500S	Sal		04/75→12/77		Conventional Coil Ignition (CI), With Distributor	1	2	U1056	48236
2.5PI/2500PI	Est	25PI	10/69→10/74		For Vehicles With Distributor	1	2	U1079	48342
2.5PI/2500PI	Sal		10/69→09/71		For Vehicles With Distributor	1	2	U1079	48342
2.5PI/2500PI	Sal		10/71→08/75		Conventional Coil Ignition (CI), With Distributor	1	2	U1056	48236
Acclaim									
1.3		EJ	01/82→06/84		Electronic Ignition (EI), With Distributor	1	2	U1068	48305
Dolomite									
1.3, 1300			01/77→12/81		Conventional Coil Ignition (CI), With Distributor	1	2	U1056	48236
1.5, 1500			01/77→12/81		Conventional Coil Ignition (CI), With Distributor	1	2	U1056	48236
1.9, 1850		WF	01/72→12/81		For Vehicles With Distributor	1	2	U1056	48236
GT6 MK 1									
2.0		KE1L	07/66→12/68		For Vehicles With Distributor	1	2	U1079	48342
GT6 MK 2									
2.0			10/70→12/70		Conventional Coil Ignition (CI), With Distributor	1	2	U1056	48236
2.0			12/68→09/70		For Vehicles With Distributor	1	2	U1079	48342
GT6 MK 3									
2.0		KE2L	12/71→12/72		Conventional Coil Ignition (CI), With Distributor	1	2	U1056	48236
Herald									
1.1, 1200	Cnv	AJM	04/61→04/64		For Vehicles With Distributor	1	2	U1061	48298
1.1, 1200	Cnv	AJM	04/61→04/64		For Vehicles With Distributor	1	2	U1079	48342
1.1, 1200	Est	AJM	07/61→04/64		For Vehicles With Distributor	1	2	U1061	48298
1.1, 1200	Sal	AJM	01/68→12/69		For Vehicles With Distributor	1	2	U1079	48342
Spitfire 1500									
1.5		FM11	01/75→01/80		Conventional Coil Ignition (CI), With Distributor	1	2	U1056	48236
Spitfire MK 1									
1.1		AJM	10/62→01/65		For Vehicles With Distributor	1	2	U1061	48298
Spitfire MK 2									
1.1		AJM	12/65→03/67		For Vehicles With Distributor	1	2	U1079	48342
Spitfire MK 3									
1.3		FM3	12/67→12/70		Conventional Coil Ignition (CI), With Distributor	1	2	U1079	48342
Stag MK 1									
3.0			06/70→02/73		For Vehicles With Distributor	1	2	U1056	48236
Stag MK 2									
3.0			02/73→12/77		For Vehicles With Distributor	1	2	U1056	48236
TR6									
2.5		CF1	07/73→12/76		For Vehicles With Distributor	1	2	U1056	48236
2.5		CF1	11/72→06/73		For Vehicles With Distributor	1	2	U1079	48342
TR7									
2.0, Drop Head Coupe	Cnv	CG2	01/80→12/81		For Vehicles With Distributor	1	2	U1056	48236
2.0, Fixed Head Coupe	Cpe	CG2	01/76→12/81		For Vehicles With Distributor	1	2	U1056	48236
Vitesse MK 1									
2.0, 2000	Cnv, Sal	HB1LE	01/67→12/67		For Vehicles With Distributor	1	2	U1079	48342
Vitesse MK 2									
2.0, 2000	Cnv, Sal	HB1HE	12/68→07/71		For Vehicles With Distributor	1	2	U1079	48342

LITRE / MODEL	BODY	ENGINE TYPE	DATE	ADDITIONAL INFORMATION	FITMENT INFORMATION	NO. OF COILS	NO. OF PINS	PART NO.	STOCK NO.
TVR									
Cerbera									
4.0, Speed Six			04/98→12/99	Angular Connector		1	4	U2043	48193
4.2			01/00→10/03		For Vehicles Without Distributor	1	4	U2009	48030
4.5			01/97→10/03		For Vehicles Without Distributor	1	4	U2009	48030
Chimaera									
4.0		39SE	01/93→12/00		For Vehicles With Distributor	1	2	U1076	48339
4.0 High Compression			12/94→06/97		For Vehicles With Distributor	1	2	U1076	48339
Griffith									
4.0			01/92→12/93		For Vehicles With Distributor	1	2	U1076	48339
SE Range									
4.2, 420SE/420SEAC			04/85→12/88		Electronic Ignition (EI), With Distributor	1	2	U1076	48339
4.4, 450SE			01/89→12/90		For Vehicles With Distributor	1	2	U1076	48339
4.4, 450SEAC			01/89→12/89		For Vehicles With Distributor	1	2	U1076	48339

VAUXHALL/OPEL									
Adam									
1.2		A12XEL	10/12→			1	7	U6039	48404
1.4		A14XEL	10/12→			1	7	U6039	48404
1.4		A14XER	10/12→			1	7	U6039	48404
Agila (00→08)									
1.0		Z10XE	09/00→10/03			1	5	U6007	48022
1.0		Z10XEP	10/03→11/06			1	5	U6022	48126
1.2		Z12XE	09/00→12/04			1	6	U6010	48043
1.2, Twinport		Z12XEP	10/04→11/06			1	6	U6019	48083
Agila (08→14)									
1.0		K10B	01/08→01/11			3	3	U5309	49047
1.2		K12B	05/08→			4	3	U5309	49047
Antara (07→11)									
2.4		Z24XED	02/07→12/08	Oval Connector		1	3	U2031	48142
Astra MK 1 (D) (80→84)									
1.2	Hbk	12S	02/82→08/84	With Bracket	For Vehicles With Distributor	1	4	U1002	48029
1.2	Hbk	12S	02/82→08/84		For Vehicles With Distributor	1	3	U1010	48069
1.2	Hbk	12S	02/82→08/84		For Vehicles With Distributor	1	2	U1064	48301
1.3	Est, Hbk	13S	02/80→08/84	With Bracket	For Vehicles With Distributor	1	4	U1002	48029
1.6	Est	16SH	12/81→12/84	With Bracket	For Vehicles With Distributor	1	4	U1002	48029
1.6	Est	16SH	12/81→12/84		For Vehicles With Distributor	1	2	U1069	48306
1.6	Hbk	16S	12/81→12/84	With Bracket	For Vehicles With Distributor	1	4	U1002	48029
1.6	Hbk	16S	12/81→12/84		For Vehicles With Distributor	1	2	U1069	48306
1.8	Hbk	18E	04/83→12/84		For Vehicles With Distributor	1	2	U1069	48306
Astra MK 2 (E) (84→93)									
1.2	Hbk	12S	10/84→08/91	With Bracket	For Vehicles With Distributor	1	4	U1002	48029
1.2	Hbk	12S	10/84→08/91		For Vehicles With Distributor	1	3	U1010	48069
1.2	Hbk	12S	10/84→08/91		For Vehicles With Distributor	1	2	U1064	48301
1.3	Est, Hbk	13S	10/84→12/89	With Bracket	For Vehicles With Distributor	1	4	U1002	48029
1.3	Van	13S	12/86→09/89	With Bracket	For Vehicles With Distributor	1	4	U1002	48029
1.3, Bedford	Van	13S	12/86→09/89	With Bracket	For Vehicles With Distributor	1	4	U1002	48029
1.4	Est	14NV	10/89→08/91	With Bracket	For Vehicles With Distributor	1	4	U1005	48057
1.4	Est	14NV	10/89→08/91		For Vehicles With Distributor	1	2	U1082	48345
1.4	Est	14NV	10/89→08/91		Incl. Control Unit, For Vehicles Without Distributor	1	4	U2004	48012
1.4	Hbk	14NV	01/90→08/91	With Bracket	For Vehicles With Distributor	1	4	U1005	48057
1.4	Hbk	14NV	01/90→08/91		For Vehicles With Distributor	1	2	U1082	48345
1.4	Hbk	14NV	01/90→08/91		Incl. Control Unit, For Vehicles Without Distributor	1	4	U2004	48012
1.4, SPi Catalyst	Hbk	C14NZ	08/90→08/91	With Bracket	For Vehicles With Distributor	1	4	U1005	48057
1.4, SPi Catalyst	Hbk	C14NZ	08/90→08/91	From Ch. No.: 2T14053	Incl. Control Unit, For Vehicles Without Distributor	1	4	U2004	48012
1.6	Cnv	16SV	03/87→12/91	With Bracket	For Vehicles With Distributor	1	4	U1002	48029

LITRE / MODEL	BODY	ENGINE TYPE	DATE	ADDITIONAL INFORMATION	FITMENT INFORMATION	NO. OF COILS	NO. OF PINS	PART NO.	STOCK NO.
VAUXHALL/OPEL (continued)									
Astra MK 2 (E) (84→93)									
1.6	Cnv	16SV	03/87→12/91	With Bracket	For Vehicles With Distributor	1	4	U1005	48057
1.6	Est	16S, 16SH	10/84→08/86	With Bracket	For Vehicles With Distributor	1	4	U1002	48029
1.6	Est	16S, 16SH	10/84→08/86		For Vehicles With Distributor	1	2	U1069	48306
1.6	Est, Hbk	16SV	08/86→08/91	With Bracket	For Vehicles With Distributor	1	4	U1002	48029
1.6	Est, Hbk	16SV	08/86→08/91	With Bracket	For Vehicles With Distributor	1	4	U1005	48057
1.6	Est, Hbk	16SV	08/86→08/91		For Vehicles With Distributor	1	2	U1069	48306
1.6	Est, Hbk	16SV	08/86→08/91		For Vehicles With Distributor	1	2	U1082	48345
1.6	Hbk	16SH	10/84→08/86	With Bracket	For Vehicles With Distributor	1	4	U1002	48029
1.6	Hbk	16SH	10/84→08/86		For Vehicles With Distributor	1	2	U1069	48306
1.6, Catalyst	Cnv	16SV	10/91→10/93	With Bracket	For Vehicles With Distributor	1	4	U1002	48029
1.6, Catalyst	Cnv	16SV	10/91→10/93	With Bracket	For Vehicles With Distributor	1	4	U1005	48057
1.8	Est	18E	11/90→08/91	With Bracket	For Vehicles With Distributor	1	4	U1005	48057
1.8	Est	18E	11/90→08/91		For Vehicles With Distributor	1	2	U1069	48306
1.8	Est	18E	11/90→08/91		For Vehicles With Distributor	1	2	U1083	48346
1.8	Hbk	18E, 18SE	10/84→08/91	With Bracket	For Vehicles With Distributor	1	4	U1005	48057
1.8	Hbk	18E, 18SE	10/84→08/91		For Vehicles With Distributor	1	2	U1069	48306
1.8	Hbk	18E, 18SE	10/84→08/91		For Vehicles With Distributor	1	2	U1083	48346
2.0	Cnv	20NE	03/87→08/88	To Ch. No.: J2791967/ J5273427/JE215465	For Vehicles With Distributor	1	2	U1069	48306
2.0	Cnv	20NE	09/88→12/91	From Ch. No.: J2791968/ J5273428/JE215466	For Vehicles With Distributor	1	2	U1083	48346
2.0	Hbk	20NE	03/87→08/91		For Vehicles With Distributor	1	2	U1083	48346
2.0	Hbk	C20XE	09/90→08/91		For Vehicles Without Distributor	1	3	U2015	48053
2.0, Catalyst	Cnv	C20NE	10/91→08/93		For Vehicles With Distributor	1	2	U1083	48346
Astra MK 3 (F) (91→98)									
1.4	Est	X14XE	02/96→01/98	With Bracket	For Vehicles With Distributor	1	4	U1005	48057
1.4	Est	X14XE	02/96→01/98		Incl. Control Unit, For Vehicles Without Distributor	1	4	U2004	48012
1.4	Est	X14XE	02/96→01/98			1	6	U6002	48006
1.4	Hbk	X14XE	02/96→02/98	With Bracket	For Vehicles With Distributor	1	4	U1005	48057
1.4	Hbk	X14XE	02/96→02/98		Incl. Control Unit, For Vehicles Without Distributor	1	4	U2004	48012
1.4	Hbk	X14XE	02/96→02/98			1	6	U6002	48006
1.4, MPi	Est	C14SE	10/91→02/98	With Bracket	For Vehicles With Distributor	1	4	U1005	48057
1.4, MPi	Est	C14SE	10/91→02/98	From Ch. No.: 2T14053	Incl. Control Unit, For Vehicles Without Distributor	1	4	U2004	48012
1.4, MPi	Hbk	C14SE	03/92→02/98	With Bracket	For Vehicles With Distributor	1	4	U1005	48057
1.4, MPi	Hbk	C14SE	03/92→02/98	From Ch. No.: 2T14053	Incl. Control Unit, For Vehicles Without Distributor	1	4	U2004	48012
1.4, MPi	Sal	C14SE	04/92→12/96	With Bracket	For Vehicles With Distributor	1	4	U1005	48057
1.4, MPi	Sal	C14SE	04/92→12/96		Incl. Control Unit, For Vehicles Without Distributor	1	4	U2004	48012
1.4, SPi	Est, Hbk	C14NZ, X14NZ	10/91→02/98	With Bracket	For Vehicles With Distributor	1	4	U1005	48057
1.4, SPi	Est, Hbk	C14NZ, X14NZ	10/91→02/98	From Ch. No.: 2T14053	Incl. Control Unit, For Vehicles Without Distributor	1	4	U2004	48012
1.4, SPi	Sal	C14NZ, X14NZ	04/92→12/94	With Bracket	For Vehicles With Distributor	1	4	U1005	48057
1.4, SPi	Sal	C14NZ, X14NZ	04/92→12/94		Incl. Control Unit, For Vehicles Without Distributor	1	4	U2004	48012
1.4, SPi	Van	C14NZ	10/91→10/94	With Bracket	For Vehicles With Distributor	1	4	U1005	48057
1.4, SPi	Van	C14NZ	10/91→10/94		Incl. Control Unit, For Vehicles Without Distributor	1	4	U2004	48012
1.6	Van	C16NZ	02/96→08/98	With Bracket	For Vehicles With Distributor	1	4	U1002	48029
1.6	Van	C16NZ	02/96→08/98	With Bracket	For Vehicles With Distributor	1	4	U1005	48057
1.6	Van	C16NZ	02/96→08/98		Incl. Control Unit, For Vehicles Without Distributor	1	4	U2004	48012
1.6, E-Drive	Cnv	X16SZ	04/94→01/96	With Bracket	For Vehicles With Distributor	1	4	U1005	48057
1.6, E-Drive	Cnv	X16SZ	04/94→01/96		Incl. Control Unit, For Vehicles Without Distributor	1	4	U2004	48012
1.6, E-Drive	Est, Hbk	X16SZ	07/94→01/96	With Bracket	For Vehicles With Distributor	1	4	U1005	48057
1.6, E-Drive	Est, Hbk	X16SZ	07/94→01/96		Incl. Control Unit, For Vehicles Without Distributor	1	4	U2004	48012

LITRE / MODEL	BODY	ENGINE TYPE	DATE	ADDITIONAL INFORMATION	FITMENT INFORMATION	NO. OF COILS	NO. OF PINS	PART NO.	STOCK NO.
VAUXHALL/OPEL (continued)									
Astra MK 3 (F) (91→98)									
1.6, E-Drive	Van	X16SZ	08/94→02/96	With Bracket	For Vehicles With Distributor	1	4	U1005	48057
1.6, E-Drive	Van	X16SZ	08/94→02/96		Incl. Control Unit, For Vehicles Without Distributor	1	4	U2004	48012
1.6, MPi	Est	C16SE	03/92→12/94	With Bracket	For Vehicles With Distributor	1	4	U1005	48057
1.6, MPi	Est	C16SE	03/92→12/94		Incl. Control Unit, For Vehicles Without Distributor	1	4	U2004	48012
1.6, MPi	Est, Hbk	X16XEL	08/94→02/98	With Bracket	For Vehicles With Distributor	1	4	U1005	48057
1.6, MPi	Est, Hbk	X16XEL	08/94→02/98		Incl. Control Unit, For Vehicles Without Distributor	1	4	U2004	48012
1.6, MPi	Est, Hbk	X16XEL	08/94→02/98			1	6	U6002	48006
1.6, MPi	Hbk	C16SE	03/92→02/98	With Bracket	For Vehicles With Distributor	1	4	U1005	48057
1.6, MPi	Hbk	C16SE	03/92→02/98		Incl. Control Unit, For Vehicles Without Distributor	1	4	U2004	48012
1.6, MPi	Hbk	C16SE	03/92→02/98			1	6	U6002	48006
1.6, MPi	Sal	C16SE	05/92→12/94	With Bracket	For Vehicles With Distributor	1	4	U1005	48057
1.6, MPi	Sal	C16SE	05/92→12/94		Incl. Control Unit, For Vehicles Without Distributor	1	4	U2004	48012
1.6, MPi	Sal	X16XEL	08/94→09/98	With Bracket	For Vehicles With Distributor	1	4	U1005	48057
1.6, MPi	Sal	X16XEL	08/94→09/98		Incl. Control Unit, For Vehicles Without Distributor	1	4	U2004	48012
1.6, MPi	Sal	X16XEL	08/94→09/98			1	6	U6002	48006
1.6, SPi	Cnv	X16SZR	01/96→07/99		Incl. Control Unit, For Vehicles Without Distributor	1	4	U2004	48012
1.6, SPi	Est	C16NZ, E16NZ	01/96→02/98	With Bracket	For Vehicles With Distributor	1	4	U1005	48057
1.6, SPi	Est	C16NZ, E16NZ	01/96→02/98		Incl. Control Unit, For Vehicles Without Distributor	1	4	U2004	48012
1.6, SPi	Est, Hbk	C16NZ, E16NZ	01/96→02/98	With Bracket	For Vehicles With Distributor	1	4	U1002	48029
1.6, SPi	Sal	C16NZ, X16SZR	01/96→09/98	With Bracket	For Vehicles With Distributor	1	4	U1002	48029
1.6, SPi	Sal	C16NZ, X16SZR	01/96→09/98	With Bracket	For Vehicles With Distributor	1	4	U1005	48057
1.6, SPi	Sal	C16NZ, X16SZR	01/96→09/98		Incl. Control Unit, For Vehicles Without Distributor	1	4	U2004	48012
1.6, SPi	Van	C16NZ	10/91→12/94	With Bracket	For Vehicles With Distributor	1	4	U1002	48029
1.6, SPi	Van	C16NZ	10/91→12/94	With Bracket	For Vehicles With Distributor	1	4	U1005	48057
1.6, SPi	Van	C16NZ	10/91→12/94		Incl. Control Unit, For Vehicles Without Distributor	1	4	U2004	48012
1.8	Cnv	C18XEL, X18XE	11/94→12/99			1	4	U2016	48056
1.8	Est	C18XEL, X18XE	09/94→07/96			1	4	U2016	48056
1.8	Est, Hbk		06/93→12/94			1	4	U2016	48056
1.8	Hbk	C18XEL	09/94→07/96			1	4	U2016	48056
1.8	Sal	C18XE	06/93→10/94			1	4	U2016	48056
2.0	Cnv	C20NE	07/93→10/94		For Vehicles With Distributor	1	2	U1083	48346
2.0	Est, Hbk	C20NE	10/91→12/93		For Vehicles With Distributor	1	2	U1083	48346
2.0	Est, Hbk	X20XEV	04/95→02/98			1	4	U2016	48056
2.0	Hbk	C20XE	10/91→04/95		For Vehicles Without Distributor	1	3	U2015	48053
2.0	Sal	C20NE	03/92→12/93		For Vehicles With Distributor	1	2	U1083	48346
Astra MK 4 (G) (98→06)									
1.4	Est	X14XE, Z14XE	02/98→03/05			1	6	U6002	48006
1.4	Hbk	X14XE, Z14XE	02/98→05/05			1	6	U6002	48006
1.4, Dual Fuel	Est, Hbk	X14XE, Z14XE	09/99→06/03			1	6	U6002	48006
1.6	Cnv	Z16XE	08/01→04/03			1	6	U6002	48006
1.6	Est	X16SZR	03/98→09/00		Incl. Control Unit, For Vehicles Without Distributor	1	4	U2004	48012
1.6	Est	X16XEL, Z16XE	03/98→10/03			1	6	U6002	48006
1.6	Est	Z16SE	09/00→04/04	Oval Connector		1	4	U2021	48080
1.6	Hbk	X16SZR	02/98→09/00		Incl. Control Unit, For Vehicles Without Distributor	1	4	U2004	48012
1.6	Hbk	X16XEL, Z16XE	02/98→03/05			1	6	U6002	48006
1.6	Hbk, Sal	Z16SE	09/00→08/04	Oval Connector		1	4	U2021	48080
1.6	Sal	C16SEL, X16XEL, Z16XE, Z16XEP	10/98→08/00			1	6	U6002	48006
1.6	Sal, Van	X16SZR	09/98→09/00		Incl. Control Unit, For Vehicles Without Distributor	1	4	U2004	48012

LITRE / MODEL	BODY	ENGINE TYPE	DATE	ADDITIONAL INFORMATION	FITMENT INFORMATION	NO. OF COILS	NO. OF PINS	PART NO.	STOCK NO.
VAUXHALL/OPEL (continued)									
Astra MK 4 (G) (98→06)									
1.6	Van	X16SZR	09/98→09/00	With Bracket	For Vehicles With Distributor	1	4	U1005	48057
1.6	Van	Z16SE	09/00→10/04	Oval Connector		1	4	U2021	48080
1.6, Dual Fuel	Est	X16SZR	03/98→12/00		Incl. Control Unit, For Vehicles Without Distributor	1	4	U2004	48012
1.6, Dual Fuel	Est	X16XEL, Z16XE	09/99→04/04			1	6	U6002	48006
1.6, Dual Fuel	Hbk	X16SZR	02/98→09/00		Incl. Control Unit, For Vehicles Without Distributor	1	4	U2004	48012
1.6, Dual Fuel	Hbk	X16XEL, Z16XE	09/99→08/04			1	6	U6002	48006
1.6, Dual Fuel	Sal	C16SEL, X16XEL, Z16XE, Z16XEP	09/99→08/00			1	6	U6002	48006
1.6, Dual Fuel	Sal	X16SZR	09/98→09/00		Incl. Control Unit, For Vehicles Without Distributor	1	4	U2004	48012
1.6, Dual Fuel	Van	X16SZR	10/98→09/00	With Bracket	For Vehicles With Distributor	1	4	U1005	48057
1.6, Dual Fuel	Van	X16SZR	10/98→09/00		Incl. Control Unit, For Vehicles Without Distributor	1	4	U2004	48012
1.6, Dual Fuel	Van	Z16SE	09/00→10/04	Oval Connector		1	4	U2021	48080
1.6, Dual Fuel	Van	Z16XE1, Z16XEP	03/05→12/05			1	6	U6001	48004
1.8	Cnv	Z18XE	04/01→10/05			1	5	U6003	48011
1.8	Cpe	Z18XE	09/00→06/04			1	5	U6003	48011
1.8	Est	X18XE1	02/98→08/00			1	5	U6003	48011
1.8	Est	Z18XE	09/00→03/05			1	5	U6003	48011
1.8	Hbk	X18XE1	02/98→09/00			1	5	U6003	48011
1.8	Hbk	Z18XE	09/00→08/04			1	5	U6003	48011
1.8	Sal	X18XE1	10/98→09/00			1	5	U6003	48011
1.8	Sal	Z18XE	09/00→07/04			1	5	U6003	48011
1.8, Dual Fuel	Cpe	Z18XE	07/02→08/04			1	5	U6003	48011
1.8, Dual Fuel	Est, Hbk, Sal	Z18XE	07/02→12/03			1	5	U6003	48011
2.0	Hbk	X20XEV	08/98→12/01			1	4	U2016	48056
2.0, GSi Turbo	Hbk	Z20LET	11/02→08/04			1	6	U6025	48135
2.0, SRi Turbo	Hbk	Z20LET	04/02→12/02			1	6	U6025	48135
2.0, Turbo	Cnv	Z20LET	03/02→08/05			1	6	U6025	48135
2.0, Turbo	Cpe	Z20LET	09/00→06/04			1	6	U6025	48135
2.2	Cnv	Z22SE	04/01→10/05			1	9	U6026	48146
2.2	Cpe	Z22SE	07/00→06/04			1	9	U6026	48146
2.2	Est	Z22SE	06/02→03/05			1	9	U6026	48146
2.2	Hbk	Z22SE	03/01→08/04			1	9	U6026	48146
Astra MK 5 (H) (04→13)									
1.4	Est	Z14XEP	11/04→03/09			1	6	U6019	48083
1.4	Hbk	Z14XEP	05/04→11/10			1	6	U6019	48083
1.4	Van	Z14XEP	10/06→12/10			1	6	U6019	48083
1.6	Est	Z16XEP	11/04→06/07			1	6	U6001	48004
1.6	Est	Z16XER	12/06→03/09			1	6	U6001	48004
1.6	Hbk	Z16XEP	05/04→06/07			1	6	U6001	48004
1.6	Hbk	Z16XER	12/06→11/10			1	6	U6001	48004
1.6, Turbo	Est	Z16LET	02/07→03/09			1	6	U6001	48004
1.6, Turbo	Hbk	Z16LET	02/07→11/10			1	6	U6001	48004
1.6, TwinTop	Cnv	Z16XEP	05/06→06/07			1	6	U6001	48004
1.6, TwinTop	Cnv	Z16XER	12/06→11/10			1	6	U6001	48004
1.8	Est	Z18XE	11/04→04/08			1	5	U6003	48011
1.8	Est	Z18XER	02/08→03/09			1	6	U6001	48004
1.8	Hbk	Z18XE	05/04→04/08			1	5	U6003	48011
1.8	Hbk	Z18XER	06/06→11/10			1	6	U6001	48004
1.8, TwinTop VVT	Cnv	Z18XER	05/08→11/10			1	6	U6001	48004
2.0, T	Est	Z20LEL	08/04→06/07			1	6	U6025	48135
2.0, T	Est, Hbk	Z20LER	01/05→06/07			1	6	U6025	48135
2.0, T	Hbk	Z20LEL	05/04→06/07			1	6	U6025	48135
2.0, TwinTop Turbo	Cnv	Z20LER	05/06→06/10			1	6	U6025	48135
2.0, VXR	Hbk	Z20LEH	02/09→11/10			1	6	U6025	48135

LITRE / MODEL	BODY	ENGINE TYPE	DATE	ADDITIONAL INFORMATION	FITMENT INFORMATION	NO. OF COILS	NO. OF PINS	PART NO.	STOCK NO.
VAUXHALL/OPEL (continued)									
Astra MK 6 (J) (09→)									
1.4		A14XEL	12/09→			1	7	U6039	48404
1.4		A14XER	12/09→			1	7	U6039	48404
1.4, GTC Turbo 120		A14NEL	11/09→			1	7	U6039	48404
1.4, GTC Turbo 140		A14NET	11/09→			1	7	U6039	48404
1.4, Turbo		A14NET	12/09→			1	7	U6039	48404
1.6, 115	Est	A16XER	08/10→			1	7	U6041	48406
1.6, 115	Hbk, Sal	A16XER	12/09→			1	7	U6042	48407
1.6, GTC Turbo 180		A16LET	09/11→05/14			1	7	U6041	48406
1.6, Turbo 180	Hbk	A16LET	12/09→			1	7	U6041	48406
Astramax (86→94)									
1.4, SPi		C14NZ	10/91→07/94	With Bracket	For Vehicles With Distributor	1	4	U1005	48057
1.6, SPi		C16NZ	10/91→07/94	With Bracket	For Vehicles With Distributor	1	4	U1002	48029
Belmont (86→91)									
1.3		13S	01/86→12/89	With Bracket	For Vehicles With Distributor	1	4	U1002	48029
1.4, SPi Catalyst		C14NZ	08/90→12/91	With Bracket	For Vehicles With Distributor	1	4	U1005	48057
1.6		16SH	01/86→08/86	With Bracket	For Vehicles With Distributor	1	4	U1002	48029
1.6		16SH	01/86→08/86	With Bracket	For Vehicles With Distributor	1	4	U1005	48057
1.6		16SH	01/86→08/86		For Vehicles With Distributor	1	2	U1069	48306
1.6		16SV	01/89→12/91	With Bracket	For Vehicles With Distributor	1	4	U1002	48029
1.6		16SV	01/89→12/91	With Bracket	For Vehicles With Distributor	1	4	U1005	48057
1.8		18E	01/86→08/86		For Vehicles With Distributor	1	2	U1069	48306
1.8		18E, 18SE	01/86→12/90	With Bracket	For Vehicles With Distributor	1	4	U1005	48057
1.8		18E, 18SE	09/86→12/90		For Vehicles With Distributor	1	2	U1083	48346
1.8		18SE	01/86→08/91	With Bracket	For Vehicles With Distributor	1	4	U1005	48057
1.8		18SE	09/86→08/91		For Vehicles With Distributor	1	2	U1083	48346
Calibra (90→98)									
2.0		C20NE	06/90→12/96		For Vehicles With Distributor	1	2	U1083	48346
2.0		C20XE	06/90→02/94	From Ch. No.: P1000001/ P9000001	For Vehicles Without Distributor	1	3	U2015	48053
2.0, Ecotec		X20XEV	02/94→07/97			1	4	U2016	48056
2.5		C25XE, X25XE	08/93→07/97	Angular Connector		1	4	U2043	48193
Carlton (78→86)									
1.8	Est	18S	11/82→08/86		For Vehicles With Distributor	1	2	U1069	48306
1.8	Sal	18S	12/82→08/86		For Vehicles With Distributor	1	2	U1069	48306
1.8	Sal	18S	12/82→08/86	From Ch. No.: 14258180	For Vehicles With Distributor	1	2	U1083	48346
2.0, Injection	Sal	20E	07/83→12/84		For Vehicles With Distributor	1	2	U1069	48306
Carlton (86→94)									
1.8	Est	18SV	11/86→12/90	From Eng. No.: 14258180,	For Vehicles With Distributor	1	2	U1083	48346
1.8	Est, Sal	18SV	11/86→12/90	From Eng. No.: 14258180, With Bracket	For Vehicles With Distributor	1	4	U1005	48057
1.8	Sal	18SV	11/86→12/90	From Eng. No.: 14258180	For Vehicles With Distributor	1	2	U1083	48346
1.8, Injection	Est, Sal	18SEH	11/86→12/92	From Ch. No.: 14258180	For Vehicles With Distributor	1	2	U1083	48346
2.0	Est, Sal	20SE	11/86→03/94		For Vehicles With Distributor	1	2	U1069	48306
2.0	Est, Sal	20SE	11/86→03/94		For Vehicles With Distributor	1	2	U1083	48346
2.6	Est, Sal	C26NE	09/90→03/94		For Vehicles With Distributor	1	2	U1083	48346
3.0	Est	C30NE	08/89→12/90		For Vehicles With Distributor	1	2	U1069	48306
3.0	Est	C30NE	08/89→12/90		For Vehicles With Distributor	1	2	U1083	48346
3.0	Est	C30SEJ	02/93→03/94		For Vehicles With Distributor	1	2	U1083	48346
3.0	Sal	30NE, C30NE	03/88→10/89		For Vehicles With Distributor	1	2	U1069	48306
3.0	Sal	30NE, C30NE	03/88→10/89		For Vehicles With Distributor	1	2	U1083	48346
3.0	Sal	C30SE	10/89→12/93		For Vehicles With Distributor	1	2	U1083	48346
3.6, Lotus	Sal	C36GET	09/90→09/92			3	2	U3015	48218
Cascade									
1.4, Turbo		A14NET	11/12→			1	7	U6039	48404
1.6		A16XHT	04/13→			4	4	U5315	49053
Cavalier (75→81)									
1.6	Hbk, Sal	16SCIH	01/80→08/81		For Vehicles With Distributor	1	3	U1010	48069

LITRE / MODEL	BODY	ENGINE TYPE	DATE	ADDITIONAL INFORMATION	FITMENT INFORMATION	NO. OF COILS	NO. OF PINS	PART NO.	STOCK NO.
VAUXHALL/OPEL (continued)									
Cavalier (75→81)									
1.6	Hbk, Sal	16SCIH	01/80→08/81		For Vehicles With Distributor	1	2	U1064	48301
2.0	Hbk	20S	01/80→08/81		For Vehicles With Distributor	1	3	U1010	48069
2.0	Hbk	20S	01/80→08/81		For Vehicles With Distributor	1	2	U1064	48301
2.0	Sal		01/80→01/81		For Vehicles With Distributor	1	3	U1010	48069
2.0	Sal		01/80→01/81		For Vehicles With Distributor	1	2	U1064	48301
Cavalier (81→88)									
1.3	Hbk	13S	08/83→08/88	With Bracket	For Vehicles With Distributor	1	4	U1002	48029
1.3	Sal	13S	09/81→08/88	With Bracket	For Vehicles With Distributor	1	4	U1002	48029
1.6	Est	16SH	10/83→08/88		For Vehicles With Distributor	1	2	U1064	48301
1.6	Hbk, Sal	16SH	09/81→08/88		For Vehicles With Distributor	1	2	U1064	48301
1.8	Cnv	18SE	11/85→10/88		For Vehicles With Distributor	1	2	U1069	48306
1.8	Hbk, Sal	18E	10/82→08/88		For Vehicles With Distributor	1	2	U1069	48306
2.0	Hbk	C20NE	09/86→08/88		For Vehicles With Distributor	1	2	U1069	48306
2.0	Sal	20NE, C20NE	09/86→08/88		For Vehicles With Distributor	1	2	U1064	48301
2.0	Sal	20NE, C20NE	09/86→08/88		For Vehicles With Distributor	1	2	U1069	48306
2.0, SRi 130	Hbk	20SEH	03/87→08/88		For Vehicles With Distributor	1	2	U1069	48306
2.0, SRi 130/ Calibre	Sal	20SEH	03/87→08/88		For Vehicles With Distributor	1	2	U1064	48301
Cavalier (88→95)									
1.4	Hbk, Sal	14NV	11/88→12/92	With Bracket	For Vehicles With Distributor	1	4	U1002	48029
1.4	Hbk, Sal	14NV	11/88→12/92	With Bracket	For Vehicles With Distributor	1	4	U1005	48057
1.4	Hbk, Sal	14NV	11/88→12/92		For Vehicles With Distributor	1	2	U1082	48345
1.6, Carburettor	Hbk, Sal	16SV	10/88→07/92	With Bracket	For Vehicles With Distributor	1	4	U1002	48029
1.6, Carburettor	Hbk, Sal	16SV	10/88→07/92	With Bracket	For Vehicles With Distributor	1	4	U1005	48057
1.6, Carburettor	Hbk, Sal	16SV	10/88→07/92		For Vehicles With Distributor	1	2	U1069	48306
1.6, Catalyst	Hbk, Sal	E16NZ	03/91→11/95	With Bracket	For Vehicles With Distributor	1	4	U1002	48029
1.6, Catalyst	Hbk, Sal	E16NZ	03/91→11/95		For Vehicles With Distributor	1	2	U1069	48306
1.6, E-Drive	Hbk, Sal	X16SZ	09/93→11/95		Incl. Control Unit, For Vehicles Without Distributor	1	4	U2004	48012
1.8, Carburettor	Hbk	18SV, C18NZ	10/89→10/90	With Bracket	For Vehicles With Distributor	1	4	U1005	48057
1.8, Carburettor	Sal	18SV, C18NZ	10/89→07/92	With Bracket	For Vehicles With Distributor	1	4	U1005	48057
1.8, Catalyst	Hbk, Sal	C18NZ	09/90→11/95	With Bracket	For Vehicles With Distributor	1	4	U1005	48057
2.0	Sal	20SEH	12/88→09/92		For Vehicles With Distributor	1	2	U1069	48306
2.0	Sal	20SEH	12/88→09/92		For Vehicles With Distributor	1	2	U1083	48346
2.0, Catalyst	Hbk, Sal	C20NE	03/91→12/94		For Vehicles With Distributor	1	2	U1083	48346
2.0, Ecotec	Hbk, Sal	X20XEV	03/94→11/95			1	4	U2016	48056
2.0, GSi	Sal	C20XE	10/89→12/92	From Ch. No.: P1000001, P5000001, P7000001	For Vehicles Without Distributor	1	3	U2015	48053
2.0, Injection	Hbk	20NE	10/88→07/92		For Vehicles With Distributor	1	2	U1069	48306
2.0, Injection	Hbk	20NE	10/88→07/92		For Vehicles With Distributor	1	2	U1083	48346
2.0, Injection	Sal	20NE, C20NE	10/88→10/90		For Vehicles With Distributor	1	2	U1069	48306
2.0, Injection	Sal	20NE, C20NE	10/88→07/92		For Vehicles With Distributor	1	2	U1083	48346
2.0, SRi	Hbk, Sal	20SEH	12/88→09/92		For Vehicles With Distributor	1	2	U1069	48306
2.0, SRi	Hbk, Sal	20SEH	12/88→09/92		For Vehicles With Distributor	1	2	U1083	48346
2.0, SRi Catalyst	Hbk, Sal	20SEH	03/91→09/92		For Vehicles With Distributor	1	2	U1069	48306
2.0, SRi Catalyst	Hbk, Sal	20SEH	03/91→09/92		For Vehicles With Distributor	1	2	U1083	48346
2.0, Turbo	Sal	C20LET	10/92→11/94		For Vehicles With Distributor	1	2	U1083	48346
2.5	Hbk, Sal	C25XE	03/94→10/95	Angular Connector		1	4	U2043	48193
Chevette									
1.3	Est, Hbk, Sal	13S	01/80→08/84		For Vehicles With Distributor	1	2	U1056	48236
Combo (93→01)									
1.4		C14NZ	07/94→10/01	With Bracket	For Vehicles With Distributor	1	4	U1005	48057
1.4		C14NZ	07/94→10/01		Incl. Control Unit, For Vehicles Without Distributor	1	4	U2004	48012
1.4, Dual Fuel		C14NZ	10/97→10/01	With Bracket	For Vehicles With Distributor	1	4	U1005	48057
1.4, Dual Fuel		C14NZ	10/97→10/01		Incl. Control Unit, For Vehicles Without Distributor	1	4	U2004	48012

LITRE / MODEL	BODY	ENGINE TYPE	DATE	ADDITIONAL INFORMATION	FITMENT INFORMATION	NO. OF COILS	NO. OF PINS	PART NO.	STOCK NO.
VAUXHALL/OPEL (continued)									
Combo (01→12)									
1.4, Twinport		Z14XEP	09/04→12/10	From Ch. No.: 43000001, 44000001, 46000001		1	6	U6019	48083
1.4, Twinport, Dual Fuel		Z14XEP	09/04→12/05	From Ch. No.: 43000001, 44000001, 46000001		1	6	U6019	48083
1.6		Z16SE	10/01→10/04	Oval Connector		1	4	U2021	48080
1.6, Dual Fuel		Z16SE	03/02→10/04	Oval Connector		1	4	U2021	48080
Corsa (93→00)									
1.0	Hbk	X10XE	04/97→09/00			1	5	U6007	48022
1.2	Hbk	C12NZ	04/93→12/98	With Bracket	For Vehicles With Distributor	1	4	U1005	48057
1.2	Hbk	X12SZ	04/93→12/98		Incl. Control Unit, For Vehicles Without Distributor	1	4	U2004	48012
1.2	Hbk	X12XE	08/98→09/00			1	6	U6010	48043
1.4	Hbk	C14NZ	09/93→07/99	With Bracket	For Vehicles With Distributor	1	4	U1005	48057
1.4	Hbk	X14SZ	09/93→07/99		Incl. Control Unit, For Vehicles Without Distributor	1	4	U2004	48012
1.4	Hbk	X14XE	07/95→09/00		Incl. Control Unit, For Vehicles Without Distributor	1	4	U2004	48012
1.4	Van	C14NZ	02/94→09/00	With Bracket	For Vehicles With Distributor	1	4	U1005	48057
1.4, SRi/GLS	Hbk	C14SE	04/93→12/94		Incl. Control Unit, For Vehicles Without Distributor	1	4	U2004	48012
1.6	Hbk	C16XE	08/93→08/94		Incl. Control Unit, For Vehicles Without Distributor	1	4	U2004	48012
1.6	Hbk	X16XE	09/94→09/00		Incl. Control Unit, For Vehicles Without Distributor	1	4	U2004	48012
Corsa (00→03)									
1.0	Hbk	Z10XE	10/00→10/03			1	5	U6007	48022
1.2	Hbk	Z12XE	10/00→10/03	To Ch. No.: 33999999, 34999999, 36999999		1	6	U6010	48043
1.2	Hbk	Z12XE	10/00→10/03	From Ch. No.: 43000001, 44000001, 46000001		1	6	U6019	48083
1.2	Van	Z12XE	02/01→10/03			1	6	U6010	48043
1.4	Hbk	Z14XE	10/00→10/03			1	6	U6002	48006
1.8	Hbk	Z18XE	10/00→10/03			1	5	U6003	48011
Corsa (03→07)									
1.0, Twinport	Hbk	Z10XEP	11/03→10/06			1	5	U6022	48126
1.2	Hbk	Z12XE	10/03→04/04	To Ch. No.: 33999999, 34999999, 36999999		1	6	U6010	48043
1.2	Hbk	Z12XE	10/03→04/04	From Ch. No.: 43000001, 44000001, 46000001		1	6	U6019	48083
1.2	Van	Z12XE	10/03→08/04			1	6	U6010	48043
1.2, Dual Fuel	Hbk	Z12XE	10/03→04/04	To Ch. No.: 33999999, 34999999, 36999999		1	6	U6010	48043
1.2, Dual Fuel	Hbk	Z12XE	10/03→04/04	From Ch. No.: 43000001, 44000001, 46000001		1	6	U6019	48083
1.2, Dual Fuel	Van	Z12XE	10/03→08/04			1	6	U6010	48043
1.2, Twinport	Hbk	Z12XEP	10/04→09/06			1	6	U6019	48083
1.2, Twinport	Van		10/04→09/06			1	6	U6019	48083
1.2, Twinport, Dual Fuel	Hbk	Z12XEP	10/04→12/05			1	6	U6019	48083
1.2, Twinport, Dual Fuel	Van		10/04→12/05			1	6	U6019	48083
1.4	Hbk	Z14XE	10/03→10/06			1	6	U6002	48006
1.4, Twinport	Hbk	Z14XEP	10/03→10/06			1	6	U6019	48083
1.8	Hbk	Z18XE	10/03→11/05			1	5	U6003	48011
Corsa (06→11)									
1.0	Hbk	Z10XEP	11/06→01/10			1	5	U6022	48126
1.2	Hbk	Z12XEP	11/06→05/10			1	6	U6019	48083
1.2	Van	Z12XEP	07/09→04/10			1	6	U6019	48083
1.4	Hbk	Z14XEP	07/06→05/10			1	6	U6019	48083
1.6, SRi	Hbk	A16LEL, Z16LEL	10/07→06/10			1	6	U6001	48004
1.6, VXR	Hbk	A16LER, Z16LER	04/07→12/11			1	6	U6001	48004
1.6, VXR Arctic Edition	Hbk	A16LER, Z16LER	07/08→03/09			1	6	U6001	48004
1.6, VXR Nurburgring	Hbk	A16LES	06/11→12/11		Electronic Ignition (EI)	1	6	U6001	48004

LITRE / MODEL	BODY	ENGINE TYPE	DATE	ADDITIONAL INFORMATION	FITMENT INFORMATION	NO. OF COILS	NO. OF PINS	PART NO.	STOCK NO.
VAUXHALL/OPEL (continued)									
Corsa (11→15)									
1.0		A10XEP	01/11→06/15			1	7	U6054	49077
1.2	Van	A12XEL	01/11→			1	7	U6039	48404
1.2		A12XER	01/11→			1	7	U6039	48404
1.4		A14NEL	06/12→			1	7	U6039	48404
1.4		A14XER	01/11→			1	7	U6039	48404
1.6, VXR		A16LER, Z16LER	01/11→			1	6	U6001	48004
1.6, VXR Nurburgring		A16LES	06/11→03/12		Electronic Ignition (EI)	1	6	U6001	48004
Frontera (91→98)									
2.0		C20NE	03/92→10/98	To Ch. No.: SV720102	For Vehicles With Distributor	1	2	U1083	48346
2.0		X20SE	03/92→10/98		For Vehicles Without Distributor	1	3	U2015	48053
2.2		X22XE	04/95→10/98		For Vehicles Without Distributor	1	3	U2015	48053
2.2		X22XE	04/95→10/98			1	4	U2032	48145
2.4		C24NE	03/92→07/95		For Vehicles With Distributor	1	2	U1083	48346
Frontera (98→04)									
2.2		X22SE, Y22SE, Z22SE	10/98→08/04	Oval Connector		1	4	U2018	48070
Insignia (08→14)									
1.4	Est, Hbk	A14NET	06/11→			1	7	U6039	48404
1.6, Turbo	Est	A16LET	02/09→			1	6	U6001	48004
1.6, Turbo	Hbk, Sal	A16LET	02/09→	To Ch. No.: B1999999	Electronic Ignition (EI)	1	6	U6001	48004
1.6, Turbo	Est, Hbk, Sal	A16LET	02/09→			1	7	U6041	48406
1.8	Est	A18XER	11/08→12/13			1	7	U6041	48406
1.8	Hbk, Sal	A18XER	11/08→			1	7	U6041	48406
2.8		A28NER, A28NET	06/08→			6	4	U5130	49072
Insignia (13→)									
1.4		A14NET	08/13→			1	7	U6039	48404
1.6		A16XHT	04/13→			4	4	U5315	49053
Meriva (03→10)									
1.4, Twinport		Z14XEP	10/04→10/09			1	6	U6019	48083
1.6		Z16SE	04/03→12/04	Oval Connector		1	4	U2021	48080
1.6		Z16XE	04/03→02/06			1	6	U6002	48006
1.6		Z16XEP	02/06→10/09			1	6	U6001	48004
1.6, VXR		Z16LET	05/06→05/10			1	6	U6001	48004
1.8		Z18XE	05/03→08/05			1	5	U6003	48011
Meriva (10→)									
1.4		A14NEL	03/10→			1	7	U6039	48404
1.4		A14NET	03/10→			1	7	U6039	48404
1.4		A14XER	03/10→			1	7	U6039	48404
Mokka (12→)									
1.4		A14NET	04/13→			1	7	U6039	48404
1.4, 4WD		A14NET	09/12→			1	7	U6039	48404
1.6		A16XER	09/12→			1	7	U6042	48407
Monterey									
3.2		6VD1	05/94→07/98			3	2	U3015	48218
Nova (83→93)									
1.0	Hbk	10S	05/83→07/92		For Vehicles With Distributor	1	3	U1010	48069
1.0	Hbk	10S	05/83→07/92		For Vehicles With Distributor	1	2	U1064	48301
1.0	Sal	10S	04/83→10/87		For Vehicles With Distributor	1	3	U1010	48069
1.0	Sal	10S	04/83→10/87		For Vehicles With Distributor	1	2	U1064	48301
1.2	Hbk	12ST	08/83→02/90	With Bracket	For Vehicles With Distributor	1	4	U1002	48029
1.2	Hbk	12ST	08/83→02/90	With Bracket	For Vehicles With Distributor	1	4	U1005	48057
1.2	Hbk	12ST	08/83→02/90		For Vehicles With Distributor	1	2	U1082	48345
1.2	Sal	12ST	08/83→10/87	With Bracket	For Vehicles With Distributor	1	4	U1002	48029
1.2	Sal	12ST	08/83→10/87	With Bracket	For Vehicles With Distributor	1	4	U1005	48057
1.2	Sal	12ST	08/83→10/87		For Vehicles With Distributor	1	2	U1082	48345
1.2	Van	12NV	11/90→07/93	With Bracket	For Vehicles With Distributor	1	4	U1002	48029
1.2	Van	12NV	11/90→07/93	With Bracket	For Vehicles With Distributor	1	4	U1005	48057

LITRE / MODEL	BODY	ENGINE TYPE	DATE	ADDITIONAL INFORMATION	FITMENT INFORMATION	NO. OF COILS	NO. OF PINS	PART NO.	STOCK NO.
VAUXHALL/OPEL (continued)									
Nova (83→93)									
1.2	Van	12NV	11/90→07/93		For Vehicles With Distributor	1	2	U1082	48345
1.2, SPi Catalyst	Hbk	C12NZ	02/92→03/93	With Bracket	For Vehicles With Distributor	1	4	U1005	48057
1.2, SPi Catalyst	Sal	C12NZ	02/92→12/93	With Bracket	For Vehicles With Distributor	1	4	U1005	48057
1.3	Hbk	13SB	07/83→10/89	With Bracket	For Vehicles With Distributor	1	4	U1002	48029
1.3	Sal	13SB	06/85→10/87	With Bracket	For Vehicles With Distributor	1	4	U1002	48029
1.4	Hbk, Sal	14NV	01/90→02/92	With Bracket	For Vehicles With Distributor	1	4	U1005	48057
1.4	Hbk, Sal	14NV	01/90→02/92		For Vehicles With Distributor	1	2	U1082	48345
1.4, SPi Catalyst	Hbk	C14NZ	08/90→03/93	With Bracket	For Vehicles With Distributor	1	4	U1005	48057
1.4, SPi Catalyst	Sal	C14NZ	10/90→08/92	With Bracket	For Vehicles With Distributor	1	4	U1005	48057
1.4, SRi	Hbk	C14SE	02/92→03/93	With Bracket, From Ch. No.: L4000001, To Ch. No.: 2T14052	For Vehicles With Distributor	1	4	U1005	48057
1.4, SRi	Hbk	C14SE	02/92→03/93	From Ch. No.: 2T14053	Incl. Control Unit, For Vehicles Without Distributor	1	4	U2004	48012
1.6	Hbk	C16SE, E16SE	02/92→03/93	With Bracket	For Vehicles With Distributor	1	4	U1002	48029
1.6	Hbk	C16SE, E16SE	02/92→03/93		Incl. Control Unit, For Vehicles Without Distributor	1	4	U2004	48012
Omega (94→03)									
2.0	Est	X20XE	04/94→02/01			1	4	U2016	48056
2.0	Est, Sal	X20SE	04/94→12/95		For Vehicles Without Distributor	1	3	U2015	48053
2.0	Sal	X20XE	04/94→09/99			1	4	U2016	48056
2.0, Dual Fuel	Est	X20XE	01/99→02/01			1	4	U2016	48056
2.0, Dual Fuel	Sal	X20XE	05/98→09/99			1	4	U2016	48056
2.2	Est, Sal	Y22XE, Z22XE	10/99→06/03			1	6	U6028	48159
2.5	Est, Sal	X25XE	04/94→09/00	Angular Connector		1	4	U2025	48096
2.5	Est, Sal	X25XE	04/94→04/01	Oval Connector	Vertical Primary Connection (Oval)	1	4	U2027	48106
2.5	Est, Sal	X25XE	04/94→09/00	Angular Connector		1	4	U2043	48193
2.6	Est, Sal	Y26SE	01/01→09/03		For Cyl.: 1, 3, 5, Black Connector Housing & Seal	1	5	U6029	48178
2.6	Est, Sal	Y26SE	01/01→09/03	Grey Connector	For Cyl.: 2, 4, 6	1	5	U6030	48192
3.0	Est, Sal	X30XE	06/94→05/01	Oval Connector	Vertical Primary Connection (Oval)	1	4	U2027	48106
3.0	Est, Sal	X30XE	07/94→07/00	Angular Connector		1	4	U2043	48193
3.0	Sal	X30XE	06/94→07/00	Angular Connector		1	4	U2025	48096
3.2	Est, Sal	Y32SE	02/01→09/03		For Cyl.: 1, 3, 5, Black Connector Housing & Seal	1	5	U6029	48178
3.2	Est, Sal	Y32SE	02/01→09/03	Grey Connector	For Cyl.: 2, 4, 6	1	5	U6030	48192
Royale									
3.0	Cpe, Sal	30E	10/80→12/83		For Vehicles With Distributor	1	2	U1069	48306
Senator (87→94)									
2.5		25E	09/87→10/90	From Ch. No.: J1185910, To Ch. No.: L1019854	For Vehicles With Distributor	1	2	U1083	48346
2.6		C26NE	09/90→09/93	From Ch. No.: L1000001	For Vehicles With Distributor	1	2	U1083	48346
3.0		30NE	01/88→09/90		For Vehicles With Distributor	1	2	U1069	48306
3.0		30NE	01/88→09/90		For Vehicles With Distributor	1	2	U1083	48346
3.0		C30SE	10/89→09/93	From Ch. No.: K100099, L100001	For Vehicles With Distributor	1	2	U1083	48346
Signum (03→08)									
1.8		Z18XE	12/04→07/05			1	5	U6003	48011
1.8		Z18XER	01/06→10/08			1	6	U6001	48004
2.0		Z20NET	04/03→12/09			4	4	U5244	49066
2.2		Z22YH	06/03→05/08			1	6	U6027	48151
2.8		Z28NEL	10/05→06/07			6	4	U5049	48174
3.2		Z32SE	06/03→11/05		For Cyl.: 1, 3, 5, Black Connector Housing & Seal	1	5	U6029	48178
3.2		Z32SE	06/03→11/05		For Cyl.: 2, 4, 6, Grey Connector Housing & Seal	1	5	U6031	48205
Sintra (97→99)									
2.2		X22XE	03/97→04/99			1	4	U2032	48145
3.0		X30XE	03/97→04/99	Oval Connector		1	4	U2068	48325

LITRE / MODEL	BODY	ENGINE TYPE	DATE	ADDITIONAL INFORMATION	FITMENT INFORMATION	NO. OF COILS	NO. OF PINS	PART NO.	STOCK NO.
VAUXHALL/OPEL (continued)									
Tigra (94→01)									
1.4		X14XE	11/94→12/00		Incl. Control Unit, For Vehicles Without Distributor	1	4	U2004	48012
1.6		X16XE	11/94→12/00		Incl. Control Unit, For Vehicles Without Distributor	1	4	U2004	48012
Tigra (04→10)									
1.4		Z14XEP	10/04→08/09			1	6	U6019	48083
1.8		Z18XE	10/04→08/09			1	5	U6003	48011
Vectra (95→02)									
1.6	Hbk, Sal	X16SZR	10/95→12/00		Incl. Control Unit, For Vehicles Without Distributor	1	4	U2004	48012
1.6	Hbk, Sal	X16XEL, Y16XE, Z16XE	10/95→10/01	To Ch. No.: W1285446/W7154258	Incl. Control Unit, For Vehicles Without Distributor	1	4	U2004	48012
1.6	Hbk, Sal	X16XEL, Y16XE, Z16XE	10/95→10/01	From Ch. No.: W1285447/ W7154259		1	6	U6002	48006
1.8	Est	X18XE	11/96→03/99			1	4	U2016	48056
1.8	Est	X18XE1	11/96→03/99			1	5	U6003	48011
1.8	Est	Z18XE	09/00→03/02			1	5	U6003	48011
1.8	Est, Hbk, Sal	X18XE	03/99→09/00			1	4	U2016	48056
1.8	Est, Hbk, Sal	X18XE1	03/99→09/00			1	5	U6003	48011
1.8	Hbk, Sal	X18XE	10/95→03/99			1	4	U2016	48056
1.8	Hbk, Sal	X18XE1	10/95→03/99			1	5	U6003	48011
1.8	Hbk, Sal	Z18XE	09/00→08/02			1	5	U6003	48011
1.8, Dual Fuel	Est	Z18XE	01/01→03/02			1	5	U6003	48011
1.8, Dual Fuel	Hbk, Sal	Z18XE	01/01→08/02			1	5	U6003	48011
2.0	Est	X20XEV	10/96→09/00			1	4	U2016	48056
2.0	Hbk, Sal	X20XEV	10/95→09/00			1	4	U2016	48056
2.0, Dual Fuel	Est	X20XEV	10/98→01/01			1	4	U2016	48056
2.0, Dual Fuel	Hbk, Sal	X20XEV	05/98→01/01			1	4	U2016	48056
2.2	Est, Sal	Z22SE	09/00→10/01			1	9	U6026	48146
2.2	Hbk	Z22SE	09/00→08/02			1	9	U6026	48146
2.5	Est	X25XE	11/96→08/00	Angular Connector		1	4	U2025	48096
2.5	Hbk, Sal	X25XE	10/95→08/00	Angular Connector		1	4	U2025	48096
2.5, GSi	Est	X25XE	05/98→09/99	Angular Connector		1	4	U2025	48096
2.5, GSi	Hbk, Sal	X25XE	04/98→07/00	Angular Connector		1	4	U2025	48096
2.5, Super Touring 200	Sal		03/97→12/97	Angular Connector		1	4	U2025	48096
2.6	Est, Hbk, Sal		09/00→08/02		For Cyl.: 1, 3, 5, Black Connector Housing & Seal	1	5	U6029	48178
2.6	Est, Hbk, Sal		09/00→08/02	Grey Connector	For Cyl.: 2, 4, 6	1	5	U6030	48192
Vectra (02→09)									
1.8	Est	Z18XE	11/03→08/05			1	5	U6003	48011
1.8	Hbk	Z18XE	08/02→02/06			1	5	U6003	48011
1.8	Sal	Z18XE	04/02→02/06			1	5	U6003	48011
1.8, Dual Fuel	Hbk	Z18XE	08/02→02/06			1	5	U6003	48011
1.8, Dual Fuel	Sal	Z18XE	06/02→02/06			1	5	U6003	48011
1.8, VVT	Est, Hbk, Sal	Z18XER	01/06→07/08			1	6	U6001	48004
2.0	Sal	Z20NET	04/03→12/09			4	4	U5244	49066
2.2	Est	Z22SE	11/03→01/04			1	9	U6026	48146
2.2	Est	Z22YH	01/04→07/08			1	6	U6027	48151
2.2	Hbk	Z22SE	08/02→01/04			1	9	U6026	48146
2.2	Hbk	Z22YH	01/04→08/05			1	6	U6027	48151
2.2	Sal	Z22SE	03/02→01/04			1	9	U6026	48146
2.2	Sal	Z22YH	01/04→10/08			1	6	U6027	48151
2.8	Est	Z28NEL	10/05→07/08			6	4	U5049	48174
2.8	Hbk	Z28NEL	10/05→06/08			6	4	U5049	48174
2.8, VXR	Est	Z28NET	10/06→07/08			6	4	U5049	48174
2.8, VXR	Est, Hbk	Z28NET	10/05→09/06			6	4	U5049	48174

LITRE / MODEL	BODY	ENGINE TYPE	DATE	ADDITIONAL INFORMATION	FITMENT INFORMATION	NO. OF COILS	NO. OF PINS	PART NO.	STOCK NO.
VAUXHALL/OPEL (continued)									
Vectra (02→09)									
2.8, VXR	Hbk		09/06→12/09			6	4	U5049	48174
3.2	Est	Z32SE	11/03→08/05		For Cyl.: 1, 3, 5, Black Connector Housing & Seal	1	5	U6029	48178
3.2	Est	Z32SE	11/03→08/05		For Cyl.: 2, 4, 6, Grey Connector Housing & Seal	1	5	U6031	48205
3.2	Hbk	Z32SE	08/02→12/05		For Cyl.: 1, 3, 5, Black Connector Housing & Seal	1	5	U6029	48178
3.2	Hbk	Z32SE	08/02→12/05		For Cyl.: 2, 4, 6, Grey Connector Housing & Seal	1	5	U6031	48205
3.2	Sal	Z32SE	06/03→12/05		For Cyl.: 1, 3, 5, Black Connector Housing & Seal	1	5	U6029	48178
3.2	Sal	Z32SE	06/03→12/05		For Cyl.: 2, 4, 6, Grey Connector Housing & Seal	1	5	U6031	48205
Vivaro (01→06)									
2.0		F4R720	02/02→12/06			4	2	U5001	48002
VX220 (00→05)									
2.0, Turbo		Z20LET	03/03→04/04			1	6	U6025	48135
2.2		Z22SE	09/00→03/04			1	9	U6026	48146
Zafira (99→05)									
1.6		X16XEL, Z16XE	05/99→08/05			1	6	U6002	48006
1.6, Dual Fuel		Z16YNG	08/02→06/05			1	6	U6002	48006
1.8		X18XE1	05/99→08/00			1	5	U6003	48011
1.8		Z18XE	09/00→08/05			1	5	U6003	48011
2.0, GSi Turbo		Z20LET	10/01→06/05			1	6	U6025	48135
2.2		Z22SE	08/00→08/04			1	9	U6026	48146
Zafira (05→)									
1.6		A16XER, Z16XER	04/09→			1	6	U6001	48004
1.6		Z16XEP	07/05→12/09			1	6	U6001	48004
1.8		A18XER, Z18XER	10/05→			1	6	U6001	48004
2.0, T		Z20LER	07/05→05/10			1	6	U6025	48135
2.0, VXR		Z20LEH	01/06→08/11			1	6	U6025	48135
2.2		Z22YH	07/05→08/11			1	6	U6027	48151
Zafira Tourer (11→)									
1.4, Turbo 140		A14NET	11/11→			1	7	U6039	48404
1.8		A18XER	11/11→			1	7	U6041	48406

VOLKSWAGEN									
Beetle									
1.2		D	08/70→08/72			1	2	U1062	48299
1.2		D	08/70→08/72		For Vehicles With Distributor	1	2	U1079	48342
1.2, 1200		D	06/60→12/77			1	2	U1062	48299
1.2, 1200		D	06/60→12/77		For Vehicles With Distributor	1	2	U1079	48342
1.2, 1200		M51	01/54→12/60			1	2	U1062	48299
1.3		AB	08/70→12/72		For Vehicles With Distributor	1	2	U1079	48342
1.3		AB, AR	09/72→07/75		For Vehicles With Distributor	1	2	U1079	48342
1.3, 1300		F	09/65→07/70		For Vehicles With Distributor	1	2	U1079	48342
1.6	Cnv	AD	01/71→12/72		For Vehicles With Distributor	1	2	U1079	48342
1.6	Sal	AD	08/70→08/72		For Vehicles With Distributor	1	2	U1079	48342
1.6	Cnv	AD	09/72→06/79		For Vehicles With Distributor	1	2	U1079	48342
1.6	Sal	AD, AJ, AS	09/72→12/75		For Vehicles With Distributor	1	2	U1079	48342
Beetle (99→11)									
1.4	Cnv	BCA	07/03→09/10			4	4	U5002	48003
1.4	Hbk	BCA	07/03→04/11			4	4	U5002	48003
1.6	Cnv	BFS	04/03→09/10		For Vehicles Without Distributor	1	4	U2003	48010
1.6	Hbk	AYD, BFS	08/00→04/11		For Vehicles Without Distributor	1	4	U2003	48010
1.8, T	Cnv	AWU, AWV	05/04→09/10	To Ch. No.: 9CY699000		4	4	U5022	48082
1.8, T	Cnv	AWU, AWV, BKF	05/04→09/10	From Ch. No.: 9C1600001		4	4	U5003	48005
1.8, T	Hbk	APH, AVC, AWU	05/01→04/11	To Ch. No.: 9CY699000		4	4	U5022	48082

LITRE / MODEL	BODY	ENGINE TYPE	DATE	ADDITIONAL INFORMATION	FITMENT INFORMATION	NO. OF COILS	NO. OF PINS	PART NO.	STOCK NO.
VOLKSWAGEN (continued)									
Beetle (99→11)									
1.8, T	Hbk	AVC, AWW, AWU, APH, BKF	05/01→04/11	From Ch. No.: 9C1600001		4	4	U5003	48005
2.0	Cnv	AZJ	04/03→10/10			1	6	U2011	48038
2.0	Cnv	BDC, BEV, BGD	04/03→10/10		For Vehicles Without Distributor	1	4	U2003	48010
2.0, LHD	Hbk	AQY, APK, AEG, BER, BHP, CBPA	04/99→07/00		For Vehicles Without Distributor	1	4	U2003	48010
2.0, LHD	Hbk	AZJ	04/99→07/00			1	6	U2011	48038
2.0, RHD	Hbk	AQY, APK, AEG, BER, BHP, CBPA	01/00→04/11		For Vehicles Without Distributor	1	4	U2003	48010
2.0, RHD	Hbk	AZJ	01/00→04/11			1	6	U2011	48038
2.3	Hbk	AQN	05/01→09/05			5	4	U5011	48035
Beetle (12→)									
1.2, TSI 105		CBZB	03/12→		For Vehicles Without Distributor	1	4	U2003	48010
1.4, TSI 160		CAVD, CNWA	03/12→			4	4	U5002	48003
2.0, TSI 200		CBFA, CCTA, CCZA	08/12→			4	4	U5015	48042
Bora (99→05)									
1.6		AEH, AKL, APF	02/99→12/00		For Vehicles Without Distributor	1	4	U2003	48010
1.6, Automatic		AVU, BFQ, BJH	12/00→05/05		For Vehicles Without Distributor	1	4	U2003	48010
1.6, Manual		ATN, AUS	12/00→05/05		For Vehicles Without Distributor	1	4	U2003	48010
1.6, Manual		AZD	12/00→05/05			4	4	U5002	48003
1.8, T		AGU	07/01→05/05			4	3	U5004	48008
1.8, T		AUM	07/01→05/05			4	4	U5003	48005
1.8, T		AUQ	10/02→12/04			4	4	U5003	48005
1.8, T		BAE	07/01→05/05		For Vehicles Without Distributor	1	4	U2003	48010
2.0		AQY, APK, AZH	02/99→05/05		For Vehicles Without Distributor	1	4	U2003	48010
2.0		AZJ	02/99→05/05			1	6	U2011	48038
2.3		AGZ	02/99→10/00			1	6	U2033	48150
2.3		AQN	12/00→12/04			5	4	U5011	48035
2.8, 4Motion		AQP, AUE	01/00→04/01	Oval Connector, To Ch. No.: 1J-1-900 000	For Vehicles Without Distributor	1	5	U2026	48101
2.8, 4Motion		AUE, BDE	05/00→07/04	From Ch. No.: 1J-2-000 001		6	4	U5011	48035
Caddy (86→92)									
1.6	Pck	EW	01/86→07/92			1	2	U1066	48303
1.6	Van		10/89→12/92			1	2	U1066	48303
1.8	Pck	JH	01/90→07/92			1	2	U1080	48343
1.8	Van		08/90→12/92			1	2	U1080	48343
Caddy (96→04)									
1.4	Van	AEX, APQ	04/96→07/99		Incl. Control Unit, For Vehicles With Distributor	1	3	U1001	48000
1.4	Van	AUA	02/01→01/04		For Vehicles Without Distributor	1	4	U2003	48010
1.4	Van	AUD	04/96→07/99		For Vehicles Without Distributor	1	4	U2003	48010
1.4, Kombi	MPV	AUA	02/01→01/04		For Vehicles Without Distributor	1	4	U2003	48010
1.6	Van	AEE	01/98→09/00		Incl. Control Unit, For Vehicles With Distributor	1	3	U1001	48000
1.6, Kombi	MPV	AEE	10/98→09/00		Incl. Control Unit, For Vehicles With Distributor	1	3	U1001	48000
Caddy (10→)									
2.0, EcoFuel			10/10→			1	6	U2011	48038
Caddy Maxi (10→)									
2.0, EcoFuel	MPV, Van		10/10→			1	6	U2011	48038
Caravelle (79→91)									
1.9		DG	01/85→07/87	To Ch. No.: 24-H-175000		1	2	U1080	48343
1.9		DG	08/87→07/89	From Ch. No.: 24-J-000001, To Ch. No.: 24-K-175000		1	2	U1071	48308
2.1		DJ	08/89→12/90	From Ch. No.: 24-L-000001		1	2	U1080	48343
2.1		DJ	12/87→07/89	From Ch. No.: 24-J-000001, To Ch. No.: 24-K-175000		1	2	U1071	48308
Caravelle (91→96)									
2.0		AAC	05/91→07/96		Incl. Control Unit, For Vehicles With Distributor	1	3	U1001	48000
2.0		AAC	05/91→07/96		Incl. Control Unit, For Vehicles With Distributor	1	6	U1003	48039

LITRE / MODEL	BODY	ENGINE TYPE	DATE	ADDITIONAL INFORMATION	FITMENT INFORMATION	NO. OF COILS	NO. OF PINS	PART NO.	STOCK NO.
VOLKSWAGEN (continued)									
Caravelle (91→96)									
2.5		AAF, ACU, AEN, AEU	05/91→07/96		Incl. Control Unit, For Vehicles With Distributor	1	3	U1001	48000
2.5, Turbo		AET, APL, AVT	09/96→12/98		Incl. Control Unit, For Vehicles With Distributor	1	3	U1001	48000
2.8		AES	05/96→12/98	Angular Connector	Incl. Control Unit, For Vehicles Without Distributor	1	5	U2024	48087
Caravelle (98→03)									
2.5, Turbo		AET, APL, AVT	10/98→04/03		Incl. Control Unit, For Vehicles With Distributor	1	3	U1001	48000
2.8		AES	10/98→04/00	Angular Connector	Incl. Control Unit, For Vehicles Without Distributor	1	5	U2024	48087
2.8		AMV	05/00→04/03	Angular Connector	Incl. Control Unit, For Vehicles Without Distributor	1	5	U2024	48087
Caravelle (03→10)									
3.2		BKK, CFLA	06/04→11/09			6	4	U5020	48065
CC (11→)									
1.8, TSI		CDAA	11/11→			4	4	U5015	48042
2.0, TSI 210		CCZB	11/11→			4	4	U5015	48042
Corrado (89→95)									
1.8		KR	07/89→12/91			1	2	U1071	48308
1.8, G60		PG	07/89→12/92			1	2	U1080	48343
2.0		2E, ADY	04/94→12/95		Incl. Control Unit, For Vehicles With Distributor	1	3	U1001	48000
2.0		9A	03/92→12/95		Incl. Control Unit, For Vehicles With Distributor	1	3	U1001	48000
2.9, VR6		ABV	04/93→12/95	Angular Connector, From Ch. No.: 50-P-010001	Incl. Control Unit, For Vehicles Without Distributor	1	5	U2024	48087
2.9, VR6		ABV	09/92→04/93	To Ch. No.: 50-P-010000	Incl. Control Unit, For Vehicles With Distributor	1	6	U1003	48039
Derby (78→81)									
1.1		HB	01/80→09/81		For Vehicles With Distributor	1	2	U1065	48302
1.3		HH	01/80→09/81		For Vehicles With Distributor	1	2	U1065	48302
Eos (06→11)									
1.4, TSI 122		CAXA	01/08→09/11			4	4	U5002	48003
1.4, TSI 160		CAVD	10/08→09/11			4	4	U5002	48003
1.6, FSI		BLF	08/06→03/08			4	4	U5002	48003
2.0, FSi		BVY, BVZ	08/06→05/08			4	4	U5015	48042
2.0, TSI 200		BPY, BWA, CAWB, CBFA, CCTA, CCZA	08/06→05/10			4	4	U5015	48042
2.0, TSI 210		CCZB	12/09→09/11			4	4	U5015	48042
3.2		BUB, CBRA	08/06→04/10			6	4	U5020	48065
3.6, FSI		CDVA	05/09→12/10			6	4	U5020	48065
Eos (11→)									
1.4, TSI 122		CAXA	04/11→			4	4	U5002	48003
1.4, TSI 160		CAVD	04/11→			4	4	U5002	48003
2.0, TSI 210		CCZB	04/11→			4	4	U5015	48042
Fox (06→12)									
1.2		BMD, CHFB	03/06→05/12			3	4	U5006	48015
1.4		BKR	03/06→05/12		For Vehicles Without Distributor	1	4	U2003	48010
Golf MK 1 (74→83)									
1.1		FA, FJ, GG	01/80→07/83		For Vehicles With Distributor	1	2	U1065	48302
1.3		GF	01/80→07/83		For Vehicles With Distributor	1	2	U1065	48302
1.5		JB	01/80→07/83		For Vehicles With Distributor	1	2	U1065	48302
1.6, GTi		EG	01/80→07/82		Electronic Ignition (EI)	1	2	U1078	48341
1.8, GTi		DX, JJ	09/82→12/83		Electronic Ignition (EI)	1	2	U1078	48341
Golf MK 1 (80→93)									
1.5		JB	01/80→11/83		For Vehicles With Distributor	1	2	U1065	48302
1.6, Carburettor		EW, HN	08/84→03/87	From Ch. No.: 15-E-027001		1	2	U1066	48303
1.6, Carburettor		EW, HN	11/83→07/84	To Ch. No.: 15-E-027000	For Vehicles With Distributor	1	2	U1065	48302

LITRE / MODEL	BODY	ENGINE TYPE	DATE	ADDITIONAL INFORMATION	FITMENT INFORMATION	NO. OF COILS	NO. OF PINS	PART NO.	STOCK NO.
VOLKSWAGEN (continued)									
Golf MK 1 (80→93)									
1.6, GLi		EG	04/80→07/82		For Vehicles With Distributor	1	2	U1065	48302
1.8, Carburettor		EX	03/87→09/92			1	2	U1080	48343
1.8, GLi		DX, EV, PB	09/82→12/83			1	2	U1080	48343
1.8, Injection		DX, EV, PB	05/84→12/89			1	2	U1080	48343
Golf MK 2 (83→92)									
1.0, 1050	Hbk	GN	03/84→07/84	To Ch. No.: 19-E-855000	For Vehicles With Distributor	1	2	U1065	48302
1.0, 1050	Hbk	GN	08/84→08/85	From Ch. No.: 19-E-855001		1	2	U1066	48303
1.3	Hbk	2G, HK, MH, NZ	06/86→07/87			1	2	U1080	48343
1.3	Hbk	2G, HK, MH, NZ	06/86→02/92			1	2	U1071	48308
1.3	Hbk	HK	08/84→06/85		Conventional Coil Ignition (CI)	1	2	U1066	48303
1.3	Hbk	HK	11/83→07/84		Conventional Coil Ignition (CI), With Distributor	1	2	U1065	48302
1.3	Hbk	MH	08/85→06/87		Electronic Ignition (EI)	1	2	U1071	48308
1.3	Van	HK	01/85→06/85		Conventional Coil Ignition (CI)	1	2	U1066	48303
1.3	Van	MH	08/85→12/91		Electronic Ignition (EI)	1	2	U1071	48308
1.6, Carburettor	Hbk	ABN, EZ, HM	08/84→12/90		Conventional Coil Ignition (CI)	1	2	U1066	48303
1.6, Carburettor	Hbk	ABN, EZ, HM	11/83→07/84		Conventional Coil Ignition (CI), With Distributor	1	2	U1065	48302
1.6, Carburettor	Hbk	ABN, EZ, HM	11/83→12/90		Electronic Ignition (EI)	1	2	U1080	48343
1.6, Catalyst	Hbk	RF	10/88→10/91			1	2	U1080	48343
1.8	Hbk	GU, GX, HV, RP	08/85→10/91			1	2	U1080	48343
1.8, G60	Hbk		07/89→12/91			1	2	U1080	48343
1.8, G60 Limited	Hbk		07/89→12/91			1	2	U1080	48343
1.8, GTi	Hbk	EV, GZ, PB	03/84→10/91			1	2	U1080	48343
1.8, GTi	Hbk	KR	10/86→06/90			1	2	U1080	48343
1.8, Rallye	Hbk		07/89→12/91			1	2	U1080	48343
1.8, Syncro	Hbk	1P	08/88→07/89			1	2	U1071	48308
1.8, Syncro	Hbk	1P	08/89→07/91			1	2	U1080	48343
Golf MK 3 (92→98)									
1.4	Hbk	ABD, AEX	02/92→08/97		Incl. Control Unit, For Vehicles With Distributor	1	3	U1001	48000
1.6	Hbk	ABU, AEA, AEE	09/93→08/97		Incl. Control Unit, For Vehicles With Distributor	1	3	U1001	48000
1.6	Hbk	AEK, AFT, AKS	12/96→08/97		Incl. Control Unit, For Vehicles With Distributor	1	3	U1001	48000
1.8, Manual	Cnv	AAM	08/94→05/98		Incl. Control Unit, For Vehicles With Distributor	1	3	U1001	48000
1.8, Manual	Est	AAM, ANN	03/94→12/96		Incl. Control Unit, For Vehicles With Distributor	1	3	U1001	48000
1.8, Manual	Hbk	AAM	02/92→12/96		Incl. Control Unit, For Vehicles With Distributor	1	3	U1001	48000
1.8, Manual or Automatic	Cnv	ABS, ADZ	01/94→05/98		Incl. Control Unit, For Vehicles With Distributor	1	3	U1001	48000
1.8, Manual or Automatic	Est	ABS, ADZ, ANP	03/94→04/99		Incl. Control Unit, For Vehicles With Distributor	1	3	U1001	48000
1.8, Manual or Automatic	Hbk	ABS, ACC, ADZ	05/95→12/96		Incl. Control Unit, For Vehicles With Distributor	1	3	U1001	48000
2.0	Cnv	2E, ADY, AGG, AKR	01/94→05/98		Incl. Control Unit, For Vehicles With Distributor	1	3	U1001	48000
2.0	Est	2E, ADY, AGG, AKR	03/94→04/99		Incl. Control Unit, For Vehicles With Distributor	1	3	U1001	48000
2.0, GTi	Hbk	2E, ABA, ADY, AGG, AKR	02/92→08/97		Incl. Control Unit, For Vehicles With Distributor	1	3	U1001	48000
2.0, GTi	Hbk	ABF	01/93→08/97		Incl. Control Unit, For Vehicles With Distributor	1	3	U1001	48000
2.8, VR6	Hbk	AAA	02/92→08/97	Angular Connector	Incl. Control Unit, For Vehicles Without Distributor	1	5	U2024	48087
Golf MK 4 (98→06)									
1.4	Est	AHW, AKO, APE, AXP	08/99→06/06		For Vehicles Without Distributor	1	4	U2003	48010
1.4	Est	BCA	08/99→06/06			4	4	U5002	48003
1.4	Hbk	AHW, AKO, APE, AXP	11/97→04/04		For Vehicles Without Distributor	1	4	U2003	48010

LITRE / MODEL	BODY	ENGINE TYPE	DATE	ADDITIONAL INFORMATION	FITMENT INFORMATION	NO. OF COILS	NO. OF PINS	PART NO.	STOCK NO.
VOLKSWAGEN (continued)									
Golf MK 4 (98→06)									
1.4	Hbk	BCA	11/97→04/04			4	4	U5002	48003
1.6	Cnv	AFT, AKS	06/98→12/00		Incl. Control Unit, For Vehicles With Distributor	1	3	U1001	48000
1.6	Est	AEH, AKL, APF	08/99→02/00		For Vehicles Without Distributor	1	4	U2003	48010
1.6	Hbk	AEH, AKL, APF	11/97→02/00		For Vehicles Without Distributor	1	4	U2003	48010
1.6, Automatic	Est	AVU, BFQ	12/00→06/06		For Vehicles Without Distributor	1	4	U2003	48010
1.6, Automatic	Hbk	AVU, BFQ, BJH	12/00→04/04		For Vehicles Without Distributor	1	4	U2003	48010
1.6, Manual	Est	ATN, AUS	07/00→06/06		For Vehicles Without Distributor	1	4	U2003	48010
1.6, Manual	Est	AZD, BCB	07/00→06/06			4	4	U5002	48003
1.6, Manual	Hbk	ATN, AUS	07/00→04/04		For Vehicles Without Distributor	1	4	U2003	48010
1.6, Manual	Hbk	AZD, BCB	07/00→04/04			4	4	U5002	48003
1.8	Cnv	AAM, ANN	06/98→12/00		Incl. Control Unit, For Vehicles With Distributor	1	3	U1001	48000
1.8, GTi	Hbk	AGN, BAF	11/97→06/99		For Vehicles Without Distributor	1	4	U2003	48010
1.8, T	Est	AGU	12/00→06/06			4	3	U5004	48008
1.8, T	Est	ARZ, AWD	12/00→06/06	To Ch. No.: 1J-Y-900000		4	4	U5022	48082
1.8, T	Est	AUM, AWD	12/00→06/06	From Ch. No.: 1J-1-000001		4	4	U5003	48005
1.8, T	Hbk	AGU	11/97→05/03			1	3	U5004	48008
1.8, T	Hbk	AUM	11/97→05/03			4	4	U5003	48005
1.8, T	Hbk	AUQ	05/02→04/04			4	4	U5003	48005
2.0	Cnv	AGG, AKR, ATU, AWF, AWG	06/98→06/02		Incl. Control Unit, For Vehicles With Distributor	1	3	U1001	48000
2.0	Est	APK, AQY	08/99→06/06		For Vehicles Without Distributor	1	4	U2003	48010
2.0	Est	AZJ	08/99→06/06			1	6	U2011	48038
2.0, GTi	Hbk	APK, AQY, AZG, AZJ	03/99→04/04		For Vehicles Without Distributor	1	4	U2003	48010
2.3	Est	AGZ	08/99→12/00			1	6	U2033	48150
2.3	Hbk	AGZ	11/97→10/00			1	6	U2033	48150
2.3	Hbk	AQN	12/00→04/04			5	4	U5011	48035
2.8, 4Motion	Hbk	AQP, AUE	01/00→04/01	Oval Connector, To Ch. No.: 1J-1-900 000	For Vehicles Without Distributor	1	5	U2026	48101
2.8, 4Motion	Hbk	AUE, BDE	01/00→04/04	From Ch. No.: 1J-2-000 001		6	4	U5011	48035
3.2, R32	Hbk	BFH, BML	10/02→04/04			6	4	U5020	48065
Golf MK 5 (03→10)									
1.4	Hbk	BCA	12/03→05/06			4	4	U5002	48003
1.4	Hbk	BUD	08/06→11/08	To Ch. No.: 1K-8-220 000		4	4	U5002	48003
1.4, FSi	Hbk	BKG, BLN	12/03→05/06			4	4	U5002	48003
1.4, GT TSi 170	Hbk	BLG	08/06→11/08	To Ch. No.: 1K-8-220 000		4	4	U5002	48003
1.4, TSi 120	Hbk	CAXA	01/08→11/08			4	4	U5002	48003
1.4, TSi 140	Hbk	BMV	08/06→11/08			4	4	U5002	48003
1.6	Est		08/07→09/10		For Vehicles Without Distributor	1	4	U2003	48010
1.6, FSi	Hbk	BAG, BLF, BLP	12/03→03/08			4	4	U5002	48003
2.0, Edition 30	Hbk	BYD	11/06→12/07			4	4	U5015	48042
2.0, FSi	Hbk	AXW, BLR, BLX, BLY, BVX, BVY, BVZ	01/04→08/06			4	4	U5015	48042
2.0, FSi 4Motion	Hbk	BLX, BVX	04/05→08/06			4	4	U5015	48042
2.0, GTi	Hbk	AXX, BPY, BWA, CAWB, CBFA, CCTA	01/05→11/08			4	4	U5015	48042
2.0, GTi Pirelli	Hbk		05/08→12/09			4	4	U5015	48042
3.2, R32 4Motion	Hbk	BUB, CBRA	11/05→11/08			6	4	U5020	48065
Golf MK 6 (09→14)									
1.2, TSi 85	Hbk	CBZA	05/10→		For Vehicles Without Distributor	1	4	U2003	48010
1.2, TSi 105	Cnv	CBZB	06/11→		For Vehicles Without Distributor	1	4	U2003	48010
1.2, TSi 105	Est, Hbk	CBZB	12/09→		For Vehicles Without Distributor	1	4	U2003	48010
1.4	Hbk	CGGA	01/09→06/12			4	4	U5002	48003
1.4, TSi 122	Cnv	CAXA	11/11→		For Vehicles Without Distributor	1	4	U2003	48010
1.4, TSi 122	Est	CAXA	11/09→			4	4	U5002	48003
1.4, TSi 122	Hbk	CAXA	01/09→			4	4	U5002	48003
1.4, TSi 160	Cnv	CAVD, CNWA, CTHD, CTKA	06/11→		For Vehicles Without Distributor	1	4	U2003	48010
1.4, TSi 160	Hbk	CAVD, CNWA, CTHD, CTKA	01/09→			4	4	U5002	48003

LITRE / MODEL	BODY	ENGINE TYPE	DATE	ADDITIONAL INFORMATION	FITMENT INFORMATION	NO. OF COILS	NO. OF PINS	PART NO.	STOCK NO.
VOLKSWAGEN (continued)									
Golf MK 6 (09→14)									
1.6	Hbk	BSE, BSF, CCSA, CMXA	01/09→08/10		For Vehicles Without Distributor	1	4	U2003	48010
2.0, GTI	Cnv	CCZB	11/11→			4	4	U5015	48042
2.0, GTI	Hbk	CCZB	04/09→			4	4	U5015	48042
2.0, GTI 35	Hbk	CDLG	09/11→			4	4	U5015	48042
2.0, R 4Motion	Hbk	CDLF	12/09→			4	4	U5015	48042
Golf MK 7 (12→)									
1.2, TSI 85		CJZB	10/12→			4	4	U5153	48408
1.2, TSI 105		CJZA	10/12→			4	4	U5153	48408
1.4, TSi 122		CMBA	10/12→			4	4	U5153	48408
1.4, TSI 140		CPTA	10/12→			4	4	U5153	48408
Golf Plus MK 5 (03→10)									
1.4		BCA	06/05→08/06			4	4	U5002	48003
1.4		BUD, CGGA	08/06→12/09	To Ch. No.: 1K-8-220 000		4	4	U5002	48003
1.4, FSi		BLN	07/05→12/06			4	4	U5002	48003
1.4, TSI 120		CAXA	01/08→12/09			4	4	U5002	48003
1.4, TSI 140		BMY	06/06→06/08			4	4	U5002	48003
1.4, TSi 160		CAVD, CNWA	01/09→12/09			4	4	U5002	48003
1.6, FSi		BLF	06/05→03/08			4	4	U5002	48003
2.0, FSi		BLR, BLY, BVY, BVZ	06/05→08/06			4	4	U5015	48042
Golf Plus MK 6 (09→)									
1.2, TSI 85		CBZA	05/11→		For Vehicles Without Distributor	1	4	U2003	48010
1.4			04/09→04/11			4	4	U5002	48003
1.4, TSi 122		CAXA	04/09→			4	4	U5002	48003
Jetta (80→84)									
1.3		GF	03/80→02/84		For Vehicles With Distributor	1	2	U1056	48236
1.5		JB	01/81→02/84		Conventional Coil Ignition (CI), With Distributor	1	2	U1065	48302
Jetta (84→92)									
1.3		2G, MH, NZ	06/87→12/91			1	2	U1080	48343
1.3		HK	09/84→07/85	From Ch. No.: 19-E-855001		1	2	U1066	48303
1.3		MH	08/85→06/87			1	2	U1080	48343
1.3		MH, NZ	09/87→12/91			1	2	U1071	48308
1.6		EZ, ABN	09/84→11/90		Electronic Ignition (EI)	1	2	U1080	48343
1.6		EZ, HM	09/84→11/90	From Ch. No.: 19-E-855001	Conventional Coil Ignition (CI)	1	2	U1066	48303
1.6, Catalyst		RF	11/90→10/91			1	2	U1080	48343
1.8		GU	08/89→10/91			1	2	U1071	48308
1.8		GU, GX, HV, RP	08/87→10/91			1	2	U1080	48343
1.8		GX, GU, HV	09/84→10/91			1	2	U1080	48343
1.8		KR	06/87→12/89			1	2	U1080	48343
1.8, GT/GTi		EV, GZ, PB	11/85→10/91			1	2	U1080	48343
Jetta (06→11)									
1.4, TSI 122		CAXA	01/08→10/10			4	4	U5002	48003
1.4, TSI 140		BMY	04/07→03/09			4	4	U5002	48003
1.4, TSI 160		CAVD	01/09→10/10			4	4	U5002	48003
1.4, TSI 170		BLG	04/07→12/08			4	4	U5002	48003
1.6, FSi		BLF	02/06→03/08			4	4	U5002	48003
2.0, FSi		BLR, BLY, BVY, BVZ	02/06→06/07			4	4	U5015	48042
2.0, TSI		BPY, BWA, CAWB, CBFA, CCTA, CCZA	02/06→10/10			4	4	U5015	48042
Jetta (11→)									
1.4, TSI 122		CAXA, CMSB	05/11→			4	4	U5002	48003
1.4, TSI 160		CAVD, CTHD	05/11→			4	4	U5002	48003
LT (83→93)									
2.4		DL	01/85→06/90			1	2	U1066	48303
2.4, Catalyst		DL	06/90→07/92			1	2	U1066	48303
LT (93→96)									
2.4, Catalyst		1E	03/93→06/96			1	2	U1071	48308

LITRE / MODEL	BODY	ENGINE TYPE	DATE	ADDITIONAL INFORMATION	FITMENT INFORMATION	NO. OF COILS	NO. OF PINS	PART NO.	STOCK NO.
VOLKSWAGEN (continued)									
LT (93→96)									
2.4, Catalyst		1E	03/94→06/96			1	2	U1080	48343
LT (96→06)									
2.3		AGL	09/96→12/01			2	1	U4026	48018
Lupo (99→05)									
1.0		AER, ALL	02/99→07/05		Incl. Control Unit, For Vehicles With Distributor	1	3	U1001	48000
1.0		ALD, ANV, AUC	02/99→07/05		For Vehicles Without Distributor	1	4	U2003	48010
1.4		AHW, AKQ, APE, AUA	02/99→05/04		For Vehicles Without Distributor	1	4	U2003	48010
1.4		BBY	11/01→07/05			4	4	U5002	48003
1.4, Sport		AFK, AQQ, AUB	08/99→07/05		For Vehicles Without Distributor	1	4	U2003	48010
1.6, GTi		AVY	12/00→07/05		For Vehicles Without Distributor	1	4	U2003	48010
Multivan T4 (97→03)									
2.5		AET, APL, AVT	09/97→04/03		Incl. Control Unit, For Vehicles With Distributor	1	3	U1001	48000
2.8		AES	09/97→04/00	Angular Connector	Incl. Control Unit, For Vehicles Without Distributor	1	5	U2024	48087
2.8		AMV	06/00→04/03	Angular Connector	Incl. Control Unit, For Vehicles Without Distributor	1	5	U2024	48087
Passat (73→81)									
1.6, LS	Est, Hbk	WV, YN	08/80→12/81			1	2	U1078	48341
Passat (81→88)									
1.6	Est, Hbk	WV, YN	09/81→12/85			1	2	U1078	48341
1.6	Hbk	DT	01/85→03/88			1	2	U1080	48343
1.6	Sal	DT	01/85→12/85			1	2	U1080	48343
1.8	Est	DS, JN, JV	01/83→03/88			1	2	U1080	48343
1.8	Hbk	DS, JN, JV, RM	01/83→03/88			1	2	U1080	48343
1.8	Sal	DS, JN	07/85→03/88			1	2	U1080	48343
2.0, GL5	Est	HP, JS	08/83→03/88			1	2	U1080	48343
2.0, GL5	Hbk	HP, JS	08/83→02/88			1	2	U1080	48343
2.0, GL5	Sal	HP, JS	09/85→08/86			1	2	U1080	48343
Passat (88→96)									
1.8	Est	KR	08/88→12/89			1	2	U1080	48343
1.8	Sal	KR	07/88→07/89			1	2	U1071	48308
1.8	Sal	KR	08/89→12/89			1	2	U1080	48343
1.8, L	Est	ABS, ADZ, RP	01/94→12/96		Incl. Control Unit, For Vehicles With Distributor	1	3	U1001	48000
1.8, L	Est	ABS, ADZ, RP	01/94→12/96			1	2	U1080	48343
1.8, L	Sal	ABS, ADZ	01/94→08/96		Incl. Control Unit, For Vehicles With Distributor	1	3	U1001	48000
1.8, L	Sal	RP	01/94→08/96			1	2	U1080	48343
1.8, MPi	Est	PB	04/88→12/90			1	2	U1080	48343
1.8, MPi	Sal	PB	04/88→07/89			1	2	U1071	48308
1.8, MPi	Sal	PB	08/89→07/90			1	2	U1080	48343
1.8, SPi	Est	ABS, ADZ, RP	07/88→12/93		Incl. Control Unit, For Vehicles With Distributor	1	3	U1001	48000
1.8, SPi	Est	ABS, ADZ, RP	07/88→12/93			1	2	U1080	48343
1.8, SPi	Sal	ABS, ADZ	04/88→12/93		Incl. Control Unit, For Vehicles With Distributor	1	3	U1001	48000
1.8, SPi	Sal	RP	04/88→12/93			1	2	U1080	48343
2.0	Est	2E	11/90→12/93		Incl. Control Unit, For Vehicles With Distributor	1	3	U1001	48000
2.0	Est	2E, ADY, AGG	01/94→12/96		Incl. Control Unit, For Vehicles With Distributor	1	3	U1001	48000
2.0	Est	2E, ADY, AGG	01/94→12/96		Incl. Control Unit, For Vehicles With Distributor	1	6	U1003	48039
2.0	Est, Sal	2E, ADY, AGG	11/90→12/93		Incl. Control Unit, For Vehicles With Distributor	1	6	U1003	48039
2.0	Est, Sal	ABF	03/94→12/95		Incl. Control Unit, For Vehicles With Distributor	1	3	U1001	48000

LITRE / MODEL	BODY	ENGINE TYPE	DATE	ADDITIONAL INFORMATION	FITMENT INFORMATION	NO. OF COILS	NO. OF PINS	PART NO.	STOCK NO.
VOLKSWAGEN (continued)									
Passat (88→96)									
2.0	Sal	2E, ADY, AGG	01/94→08/96		Incl. Control Unit, For Vehicles With Distributor	1	6	U1003	48039
2.0	Sal	2E, ADY, AGG	11/90→08/96		Incl. Control Unit, For Vehicles With Distributor	1	3	U1001	48000
2.8	Est, Sal	AAA	01/93→12/95	Angular Connector, From Ch. No.: 31-P-136399	Incl. Control Unit, For Vehicles Without Distributor	1	5	U2024	48087
Passat (97→00)									
1.6	Est	ADP, AHL, ANA, ARM	09/97→06/99		For Vehicles Without Distributor	1	4	U2003	48010
1.6	Sal	ADP, AHL, ANA, ARM	02/97→06/99		For Vehicles Without Distributor	1	4	U2003	48010
1.8	Est	ADR, APT, ARG	09/97→11/00		Incl. Control Unit	1	3	U6037	48048
1.8	Sal	ADR, APT, ARG	02/97→11/00		Incl. Control Unit	1	3	U6037	48048
1.8, Turbo	Est	AEB, ANB, APU	09/97→11/00			4	3	U5004	48008
1.8, Turbo	Sal	AEB, ANB, APU	02/97→11/00			1	3	U5004	48008
2.3	Est, Sal	AGZ	01/98→11/00			1	6	U2033	48150
2.8	Est	ACK, ALG, APR, AQD	01/98→11/00			1	5	U2010	48037
2.8	Sal	ACK, ALG, APR, AQD	05/99→11/00			1	5	U2010	48037
Passat (01→05)									
1.8, Turbo	Est	AWT	12/00→05/05			4	4	U5003	48005
1.8, Turbo	Sal	AWL, AWT	12/00→05/05			4	4	U5003	48005
2.0	Est	AZM	12/00→05/02		For Vehicles Without Distributor	1	4	U2003	48010
2.0	Est, Sal	ALT	05/02→05/05			4	4	U5003	48005
2.0	Sal	AZM, BFF	12/00→05/02		For Vehicles Without Distributor	1	4	U2003	48010
2.3	Est, Sal	AZX	12/00→08/04			5	4	U5046	48165
2.8, 4Motion	Est, Sal	AMX, ATQ	12/00→05/05			1	5	U2010	48037
4.0, W8	Est, Sal	BDN, BDP	12/01→12/04			8	4	U5017	48047
Passat (05→11)									
1.4, TSI 122	Est	CAXA	01/08→11/10			4	4	U5002	48003
1.4, TSI 122	Sal	CAXA	01/08→07/10			4	4	U5002	48003
1.6, FSI	Est	BLF	11/05→03/08			4	4	U5002	48003
1.6, FSI	Sal	BLF	06/05→03/08			4	4	U5002	48003
1.8, TSI	Est	BZB, CDAA	01/08→03/11			4	4	U5015	48042
1.8, TSI	Sal	BZB, CDAA	01/08→07/10			4	4	U5015	48042
2.0, FSi	Est	BLR, BLY, BVY, BVZ	11/05→03/08			4	4	U5015	48042
2.0, FSi	Sal	BLR, BLY, BVY, BVZ	06/05→03/08			4	4	U5015	48042
2.0, TFSi	Est	AXX, BPY, BWA, CAWB, CBFA, CCTA, CCZA	11/05→12/09			4	4	U5015	48042
2.0, TFSi	Sal	AXX, BPY, BWA, CAWB, CBFA, CCTA, CCZA	10/05→12/09			4	4	U5015	48042
3.2, 4Motion	Est, Sal	AXZ	11/05→12/09			6	4	U5020	48065
3.6, R36	Est	BWS	07/08→11/10			6	4	U5020	48065
3.6, R36	Sal	BWS	07/08→07/10			6	4	U5020	48065
Passat (08→12)									
1.8, CC TSI		BZB, CDAA	06/08→11/10			4	4	U5015	48042
2.0, CC TSI 200		CAWB, CBFA, CCTA, CCZA	09/08→03/11			4	4	U5015	48042
2.0, CC TSI 210		CCZB	11/10→05/12			4	4	U5015	48042
3.6, CC 4Motion		BWS	06/08→05/10			6	4	U5020	48065
Passat (10→)									
1.4, TSI 122	Est, Sal	CAXA	11/10→			4	4	U5002	48003
1.8, TSI 160	Est, Sal	CDAA	11/10→			4	4	U5015	48042
2.0, TSI 210	Est, Sal	CCZB	11/10→			4	4	U5015	48042
Phaeton (03→11)									
3.2		AYT, BKL	06/03→06/04			6	4	U5020	48065
3.2		BKL, BRK	06/04→03/08			6	4	U5020	48065
3.2, LWB		BKL, BRK	04/04→03/08			6	4	U5020	48065
6.0, W12		BAN	06/03→08/06			12	4	U5017	48047
6.0, W12 LWB		BAN	04/04→05/05			12	4	U5017	48047
6.0, W12 LWB		BRN, BTT	05/05→03/11			12	4	U5017	48047

LITRE / MODEL	BODY	ENGINE TYPE	DATE	ADDITIONAL INFORMATION	FITMENT INFORMATION	NO. OF COILS	NO. OF PINS	PART NO.	STOCK NO.
VOLKSWAGEN (continued)									
Polo Dune (06→10)									
1.4		BUD	08/06→11/09			4	4	U5002	48003
1.4			04/06→08/06			4	4	U5002	48003
Polo MK 1 (76→81)									
0.9		HA	01/80→09/81		For Vehicles With Distributor	1	2	U1079	48342
Polo MK 2 (81→90)									
1.0, 1050	Cpe, Hbk	AAK	08/89→12/90			1	2	U1080	48343
1.0, 1050	Cpe, Hbk	AAK, AAU, ACM, HZ	08/87→07/89			1	2	U1071	48308
1.0, 1050	Cpe, Hbk	AAU, ACM	08/89→12/90		Incl. Control Unit, For Vehicles With Distributor	1	3	U1001	48000
1.0, 1050	Cpe, Hbk	ACM	08/89→12/90		Incl. Control Unit, For Vehicles With Distributor	1	6	U1003	48039
1.0, 1050	Cpe, Hbk	GL	06/84→09/85	From Ch. No.: E-150001		1	2	U1066	48303
1.0, 1050	Hbk	GL	11/81→06/84	To Ch. No.: E-150000	For Vehicles With Distributor	1	2	U1065	48302
1.0, 1050	Sal	GL	01/85→10/86	From Ch. No.: E-150001		1	2	U1066	48303
1.0, SPi Catalyst	Hbk	AAK	08/89→12/90			1	2	U1080	48343
1.0, SPi Catalyst	Hbk	AAU, ACM	08/89→12/90		Incl. Control Unit, For Vehicles With Distributor	1	3	U1001	48000
1.0, SPi Catalyst	Hbk	ACM	08/89→12/90		Incl. Control Unit, For Vehicles With Distributor	1	6	U1003	48039
1.1	Cpe	HB	01/83→07/83		For Vehicles With Distributor	1	2	U1065	48302
1.1	Hbk	HB	11/81→08/83		For Vehicles With Distributor	1	2	U1065	48302
1.3	Cpe, Hbk	AAV, NZ, 2G	10/90→12/90		Incl. Control Unit, For Vehicles With Distributor	1	3	U1001	48000
1.3	Cpe, Hbk	HK	06/84→07/85	From Ch. No.: E-150001		1	2	U1066	48303
1.3	Cpe, Hbk	HK	08/83→06/84	To Ch. No.: E-150000	For Vehicles With Distributor	1	2	U1065	48302
1.3	Cpe, Hbk	MH, NZ, 2G	08/87→07/89			1	2	U1071	48308
1.3	Cpe, Hbk	NZ, 2G	08/89→08/90			1	2	U1080	48343
1.3	Cpe, Hbk	NZ, 2G	10/90→12/90		Incl. Control Unit, For Vehicles With Distributor	1	6	U1003	48039
1.3	Hbk	MH	08/87→07/88			1	2	U1071	48308
1.3	Sal	HK	07/85→07/87	From Ch. No.: E-150001		1	2	U1066	48303
1.3	Sal	MH, NZ	08/87→07/89			1	2	U1071	48308
1.3	Sal	NZ	08/89→08/90			1	2	U1080	48343
1.3	Sal	NZ	10/90→12/90		Incl. Control Unit, For Vehicles With Distributor	1	3	U1001	48000
1.3	Sal	NZ	10/90→12/90		Incl. Control Unit, For Vehicles With Distributor	1	6	U1003	48039
Polo MK 2 Facelift (90→94)									
1.0	Cpe, Hbk	AAK	11/90→09/94			1	2	U1080	48343
1.0	Cpe, Hbk	AAU, ACM	11/90→09/94		Incl. Control Unit, For Vehicles With Distributor	1	3	U1001	48000
1.0	Cpe, Hbk	ACM	11/90→09/94		Incl. Control Unit, For Vehicles With Distributor	1	6	U1003	48039
1.0	Sal	AAU, HZ	11/90→12/91		Incl. Control Unit, For Vehicles With Distributor	1	3	U1001	48000
1.0	Sal	HZ	11/90→12/91		Incl. Control Unit, For Vehicles With Distributor	1	6	U1003	48039
1.0, Injection	Van	AAU	08/92→07/94		Incl. Control Unit, For Vehicles With Distributor	1	3	U1001	48000
1.0, Injection	Van	AAU	08/92→07/94			1	2	U1080	48343
1.3	Cpe	AAV, NZ, 2G	11/90→08/94		Incl. Control Unit, For Vehicles With Distributor	1	3	U1001	48000
1.3	Cpe	NZ, 2G	11/90→08/94		Incl. Control Unit, For Vehicles With Distributor	1	6	U1003	48039
1.3	Hbk	AAV, NZ, 2G	11/90→09/94		Incl. Control Unit, For Vehicles With Distributor	1	3	U1001	48000
1.3	Hbk	NZ, 2G	11/90→09/94		Incl. Control Unit, For Vehicles With Distributor	1	6	U1003	48039
1.3	Sal	NZ	11/90→07/92		Incl. Control Unit, For Vehicles With Distributor	1	3	U1001	48000
1.3	Sal	NZ	11/90→07/92		Incl. Control Unit, For Vehicles With Distributor	1	6	U1003	48039

LITRE / MODEL	BODY	ENGINE TYPE	DATE	ADDITIONAL INFORMATION	FITMENT INFORMATION	NO. OF COILS	NO. OF PINS	PART NO.	STOCK NO.
VOLKSWAGEN (continued)									
Polo MK 2 Facelift (90→94)									
1.3, G40	Cpe	PY	04/91→09/94		Incl. Control Unit, For Vehicles With Distributor	1	3	U1001	48000
1.3, GT	Cpe	3F	11/90→09/94		Incl. Control Unit, For Vehicles With Distributor	1	3	U1001	48000
1.3, GT	Hbk	3F	11/90→12/91		Incl. Control Unit, For Vehicles With Distributor	1	3	U1001	48000
Polo MK 3 (94→00)									
1.0	Hbk	AER, ALL	09/96→10/99		Incl. Control Unit, For Vehicles With Distributor	1	3	U1001	48000
1.0	Hbk	AEV	10/94→08/96		Incl. Control Unit, For Vehicles With Distributor	1	3	U1001	48000
1.3	Hbk	ADX	10/94→07/95		Incl. Control Unit, For Vehicles With Distributor	1	3	U1001	48000
1.4	Hbk	AEX, AKV, APQ	07/95→10/99		Incl. Control Unit, For Vehicles With Distributor	1	3	U1001	48000
1.4	Hbk	AFH	09/96→10/99		Incl. Control Unit, For Vehicles With Distributor	1	3	U1001	48000
1.6	Est	AEE, ALM	05/98→01/00		Incl. Control Unit, For Vehicles With Distributor	1	3	U1001	48000
1.6	Est	AEH, AFT, AKL, APF, AUR	05/98→01/00		Incl. Control Unit, For Vehicles With Distributor	1	3	U1001	48000
1.6	Est	AEH, AFT, AKL, APF, AUR	05/98→01/00		For Vehicles Without Distributor	1	4	U2003	48010
1.6	Hbk	AEA, AEE, AHS	10/94→09/96		Incl. Control Unit, For Vehicles With Distributor	1	3	U1001	48000
1.6	Sal	AEE, ALM	04/96→01/00		Incl. Control Unit, For Vehicles With Distributor	1	3	U1001	48000
1.6	Sal	AEH, AKL, APF, AUR	10/99→01/00		For Vehicles Without Distributor	1	4	U2003	48010
1.6	Sal	AFT	04/96→08/99		Incl. Control Unit, For Vehicles With Distributor	1	3	U1001	48000
Polo MK 3 Facelift (00→02)									
1.0	Hbk	ALD, AUC	01/00→09/01		For Vehicles Without Distributor	1	4	U2003	48010
1.4	Est, Sal	APE, AUA	01/00→09/01		For Vehicles Without Distributor	1	4	U2003	48010
1.4	Hbk	AFK, AUB	01/00→09/01		For Vehicles Without Distributor	1	4	U2003	48010
1.4	Hbk	AHW, APE, AUA	01/00→09/01		For Vehicles Without Distributor	1	4	U2003	48010
1.4	Hbk	AKK, AUD	01/00→09/01		For Vehicles Without Distributor	1	4	U2003	48010
1.6	Est	AEH, AFT, AKL, APF, AUR	01/00→09/01		Incl. Control Unit, For Vehicles With Distributor	1	3	U1001	48000
1.6	Est	AEH, AFT, AKL, APF, AUR	01/00→09/01		For Vehicles Without Distributor	1	4	U2003	48010
1.6	Sal	AEH	01/00→02/02		For Vehicles Without Distributor	1	4	U2003	48010
1.6	Sal	AEH, AKL, APF, AUR	01/00→09/01		For Vehicles Without Distributor	1	4	U2003	48010
1.6, GTi	Hbk	ARC, AVY	01/00→09/01		For Vehicles Without Distributor	1	4	U2003	48010
Polo MK 4 (02→05)									
1.2		AWY, BMD	03/02→07/05			3	4	U5006	48015
1.2		AZQ, BME	02/02→07/05			3	4	U5002	48003
1.4		AUA	02/02→07/05		For Vehicles Without Distributor	1	4	U2003	48010
1.4		AUB, BBZ	03/02→07/05			4	4	U5002	48003
1.4		BKY, BBY	02/02→07/05			4	4	U5002	48003
1.4, FSi		AXU	10/02→07/05			4	4	U5002	48003
Polo MK 4 Facelift (05→10)									
1.2		AWY, BMD	06/05→04/07			3	4	U5006	48015
1.2		AZQ, BME	06/05→04/07			3	4	U5002	48003
1.2		BBM	06/07→11/09			3	4	U5006	48015
1.2		BZG	06/07→11/09			3	4	U5002	48003
1.4		AUA	06/05→08/07		For Vehicles Without Distributor	1	4	U2003	48010
1.4		AUB, BBZ	06/05→08/06			4	4	U5002	48003
1.4		BKY, BBY	06/05→08/07			4	4	U5002	48003
1.4		BUD	08/06→11/09			4	4	U5002	48003
1.4, FSi		AXU	06/05→07/06			4	4	U5002	48003
1.6		BTS	01/07→11/09			4	4	U5002	48003
1.8, GTi		BJX	05/06→11/09			4	4	U5003	48005

LITRE / MODEL	BODY	ENGINE TYPE	DATE	ADDITIONAL INFORMATION	FITMENT INFORMATION	NO. OF COILS	NO. OF PINS	PART NO.	STOCK NO.
VOLKSWAGEN (continued)									
Polo MK 5 (09→)									
1.2		CGPA	10/09→			3	4	U5002	48003
1.2			10/09→			3	4	U5006	48015
1.2, TSI		CBZB	02/10→		For Vehicles Without Distributor	1	4	U2003	48010
1.4		CDDA, CGGB, CLPA	10/09→			4	4	U5002	48003
1.4, GTI		CAVE	08/10→			4	4	U5002	48003
1.4, TSI BlueGT		CPTA	10/12→			4	4	U5153	48408
Santana (82→85)									
2.0		HP, JS	08/83→12/84			1	2	U1080	48343
Scirocco (74→81)									
1.6, Carburettor		FR	01/80→07/80		For Vehicles With Distributor	1	2	U1065	48302
1.6, Injection		EG	01/80→07/80		For Vehicles With Distributor	1	2	U1065	48302
Scirocco (81→92)									
1.5		JB	12/81→07/83		For Vehicles With Distributor	1	2	U1065	48302
1.6, Carburettor		EW	02/83→12/88			1	2	U1080	48343
1.6, Carburettor		FR	12/81→12/83		For Vehicles With Distributor	1	2	U1065	48302
1.6, Injection		EG	12/81→07/82		For Vehicles With Distributor	1	2	U1065	48302
1.8, Carburettor		EX	08/83→07/92			1	2	U1080	48343
1.8, GTX (LHD)		KR	10/85→12/87			1	2	U1080	48343
1.8, Injection		DX, EV, JJ, PB	10/82→12/89			1	2	U1080	48343
Scirocco (08→)									
1.4, TSI 122		CAXA, CMSB	12/09→			4	4	U5002	48003
1.4, TSI 160		CAVD, CNWA	10/08→			4	4	U5002	48003
2.0, R		CDLA	11/09→			4	4	U5015	48042
2.0, TSI 200		CAWB	09/08→11/09			4	4	U5015	48042
2.0, TSI 210		CCZB	12/09→05/11			4	4	U5015	48042
Sharan MK 1 Phase 1 (95→00)									
1.8		AJH, AWC	11/97→05/00			1	3	U5004	48008
1.8		AJH, AWC	11/97→05/00			4	4	U5022	48082
2.0		ADY	09/95→02/00		Incl. Control Unit, For Vehicles With Distributor	1	3	U1001	48000
2.8		AAA, AMY	09/95→04/00	Angular Connector	Incl. Control Unit, For Vehicles Without Distributor	1	5	U2024	48087
Sharan MK 1 Phase 2 (00→11)									
1.8		AJH, AWC	05/00→03/08			1	3	U5004	48008
1.8		AJH, AWC	05/00→03/08			4	4	U5022	48082
2.0		ATM	05/00→03/10		For Vehicles Without Distributor	1	4	U2003	48010
2.8		AYL	05/00→03/06			6	4	U5011	48035
2.8, 4Motion		AYL	05/00→03/06			6	4	U5011	48035
Sharan MK 2 (10→)									
1.4, TSI 150		CAVA	09/10→			4	4	U5002	48003
2.0, TSI 200		CCZA	12/10→			4	4	U5015	48042
Tiguan (08→11)									
1.4, TSI 150		BWK, CAVA	02/08→12/11			4	4	U5002	48003
2.0, TSI 170		CAWA, CCZC	07/08→12/11	From Ch. No.: 5N 9W047 645		4	4	U5014	48041
2.0, TSI 170		CAWA, CCZC	07/08→12/11	To Ch. No.: 5N 9W047 644		4	4	U5015	48042
2.0, TSI 200		CAWB, CCTA, CCZA	07/08→12/11	From Ch. No.: 5N 9W047 645		4	4	U5014	48041
2.0, TSI 200		CAWB, CCTA, CCZA	07/08→12/11	To Ch. No.: 5N 9W047 644		4	4	U5015	48042
Tiguan (11→)									
1.4, TSI 160		CAVD	07/11→			4	4	U5002	48003
2.0, TSI 180		CCZD	07/11→			4	4	U5015	48042
2.0, TSI 210		CCZB	07/11→			4	4	U5015	48042
Touareg (03→11)									
3.2		AZZ, BAA, BKJ, BMV, BMX, BRJ	05/03→04/05			6	4	U5020	48065
3.2			11/04→08/06			6	4	U5020	48065
3.6		BHK, BHL	03/07→05/10			6	4	U5020	48065
Touran (03→11)									
1.4, TSI 140		BMY, CAVC	10/06→05/10			4	4	U5002	48003

LITRE / MODEL	BODY	ENGINE TYPE	DATE	ADDITIONAL INFORMATION	FITMENT INFORMATION	NO. OF COILS	NO. OF PINS	PART NO.	STOCK NO.
VOLKSWAGEN (continued)									
Touran (03→11)									
1.6		BGU, BSE, BSF	07/03→05/10		For Vehicles Without Distributor	1	4	U2003	48010
1.6, FSI		BAG, BLF, BLP	06/03→01/07			4	4	U5002	48003
2.0, FSi		AXW, BLR, BLX, BLY, BVY, BVZ	10/03→11/05			4	4	U5015	48042
Touran (10→)									
1.2, TSI 105		CBZB	09/10→		For Vehicles Without Distributor	1	4	U2003	48010
1.4, TSI 140		CAVC, CTHC	09/10→			4	4	U5002	48003
Transporter (79→91)									
1.9	Pck	DF	01/85→12/86			1	2	U1071	48308
1.9	Pck, Van	DG	01/85→07/87	To Ch. No.: 24-H-175000		1	2	U1080	48343
1.9	Pck, Van	DG	08/87→07/89	From Ch. No.: 24-J-000001, To Ch. No.: 24-K-175000		1	2	U1071	48308
1.9	Pck, Van	DG	08/89→12/91	From Ch. No.: 14-L-000001		1	2	U1080	48343
1.9	Van	DF	10/88→12/90			1	2	U1071	48308
2.1	Pck, Van	DJ	08/87→07/89	From Ch. No.: 24-J-000001, To Ch. No.: 24-K-175000		1	2	U1071	48308
2.1	Pck, Van	DJ	08/89→12/90	From Ch. No.: 24-L-000001		1	2	U1080	48343
2.1	Pck, Van	DJ	12/86→07/87	To Ch. No.: 24-H-175000		1	2	U1080	48343
Transporter (91→96)									
1.8		PD	01/91→07/92		Incl. Control Unit, For Vehicles With Distributor	1	6	U1003	48039
1.8		PD	01/91→07/92			1	2	U1080	48343
2.0		AAC	12/90→04/96		Incl. Control Unit, For Vehicles With Distributor	1	3	U1001	48000
2.0		AAC	12/90→04/96		Incl. Control Unit, For Vehicles With Distributor	1	6	U1003	48039
2.0		AAC	04/96→12/01		Incl. Control Unit, For Vehicles With Distributor	1	3	U1001	48000
2.0		AAC	04/96→12/01		Incl. Control Unit, For Vehicles With Distributor	1	6	U1003	48039
2.5		AAF, ACU, AEN, AEU	01/94→04/96		Incl. Control Unit, For Vehicles With Distributor	1	3	U1001	48000
2.5		AET, APL, AVT	09/96→04/03		Incl. Control Unit, For Vehicles With Distributor	1	3	U1001	48000
Up (12→)									
1.0		CHYB	03/12→			4	4	U5153	48408
Vento (92→98)									
1.6		ABU, AEA, AEE	01/94→04/96		Incl. Control Unit, For Vehicles With Distributor	1	3	U1001	48000
1.8		ABS, ADZ	01/93→04/98		Incl. Control Unit, For Vehicles With Distributor	1	3	U1001	48000
2.0		2E, ADY, AGG, AKR	10/92→04/98		Incl. Control Unit, For Vehicles With Distributor	1	3	U1001	48000
2.8, VR6		AAA	10/92→01/98	To Ch. No.: 1H 9W 480 000	Incl. Control Unit, For Vehicles With Distributor	1	6	U1003	48039
2.8, VR6		AAA	10/92→01/98	Angular Connector, From Ch. No.: 1H-P-480001	Incl. Control Unit, For Vehicles Without Distributor	1	5	U2024	48087

VOLVO									
200 Series 240									
2.0, Injection	Est	B200E	08/87→10/90		For Vehicles With Distributor	1	2	U1076	48339
2.0, Injection	Sal	B200E	08/87→10/90		Electronic Ignition (EI), With Distributor	1	2	U1076	48339
2.0, Injection Catalyst	Est	B200E	08/89→10/91		For Vehicles With Distributor	1	2	U1076	48339
2.0, Injection Catalyst	Est	B200F	10/91→12/93		Electronic Ignition (EI), With Distributor	1	2	U1076	48339
2.0, Injection Catalyst	Sal	B200E	08/89→12/91		Electronic Ignition (EI), With Distributor	1	2	U1076	48339
2.1, Carburettor	Est	B21A, B21F	09/82→09/83		Electronic Ignition (EI), With Distributor	1	2	U1068	48305
2.1, Carburettor	Est, Sal	B21A	09/83→07/84		For Vehicles With Distributor	1	2	U1068	48305
2.1, Carburettor	Sal	B21A	09/82→09/83		For Vehicles With Distributor	1	2	U1068	48305
2.3, Carburettor	Est	B230F	08/86→07/87		For Vehicles With Distributor	1	2	U1076	48339
2.3, Carburettor	Sal	B230F	08/86→12/87		For Vehicles With Distributor	1	2	U1076	48339
2.3, Injection	Est	B23E	01/83→12/84		For Vehicles With Distributor	1	2	U1068	48305

LITRE / MODEL	BODY	ENGINE TYPE	DATE	ADDITIONAL INFORMATION	FITMENT INFORMATION	NO. OF COILS	NO. OF PINS	PART NO.	STOCK NO.
VOLVO (continued)									
200 Series 240									
2.3, Injection	Est	B23E	01/83→12/84		For Vehicles With Distributor	1	2	U1076	48339
2.3, Injection	Est	B23E	12/86→12/88		For Vehicles With Distributor	1	2	U1076	48339
2.3, Injection	Sal	B23E	09/82→07/83		For Vehicles With Distributor	1	2	U1068	48305
2.3, Injection Catalyst	Est	B230F	08/89→07/93		For Vehicles With Distributor	1	2	U1076	48339
2.3, Injection Catalyst	Sal	B230F	10/90→12/91		For Vehicles With Distributor	1	2	U1076	48339
200 Series 244									
2.1, Carburettor		B21A	08/80→09/82		For Vehicles With Distributor	1	2	U1068	48305
2.1, Injection		B21E	01/80→07/80		For Vehicles With Distributor	1	2	U1068	48305
2.3, Carburettor		B23A	08/80→09/82		For Vehicles With Distributor	1	2	U1068	48305
2.3, Injection		B23E	08/80→09/82		For Vehicles With Distributor	1	2	U1068	48305
200 Series 245									
2.1, Carburettor		B21A, B21F	08/80→09/82		Electronic Ignition (EI), With Distributor	1	2	U1068	48305
2.3, Carburettor		B23A	08/80→09/82		For Vehicles With Distributor	1	2	U1068	48305
300 Series 340									
1.4	Hbk	B144S	08/83→09/84		For Vehicles With Distributor	1	2	U1065	48302
1.4	Hbk	B144S	10/84→07/86		Not Incl. Control Unit, For Vehicles With Distributor	1	3	U1012	48092
1.7	Hbk	B172K	08/85→07/91		Not Incl. Control Unit, For Vehicles With Distributor	1	3	U1012	48092
1.7	Sal	B172K	08/85→07/89		Not Incl. Control Unit, For Vehicles With Distributor	1	3	U1012	48092
300 Series 343									
1.4		B144S	01/80→09/82		For Vehicles With Distributor	1	2	U1065	48302
300 Series 345									
1.4		B144S	01/80→09/82		For Vehicles With Distributor	1	2	U1065	48302
300 Series 360									
2.0	Hbk	B19A, B200K	09/82→07/84		For Vehicles With Distributor	1	2	U1068	48305
2.0	Hbk	B200F, B200K	05/85→07/87		Not Incl. Control Unit, For Vehicles With Distributor	1	3	U1012	48092
2.0	Hbk	B200F, B200K	08/88→07/89		Not Incl. Control Unit, For Vehicles With Distributor	1	3	U1012	48092
2.0	Sal	B19A	09/83→07/84		For Vehicles With Distributor	1	2	U1068	48305
2.0	Sal	B200K	08/85→07/87		Not Incl. Control Unit, For Vehicles With Distributor	1	3	U1012	48092
2.0, Injection	Hbk	B19E	09/82→07/84		Not Incl. Control Unit, For Vehicles With Distributor	1	3	U1012	48092
2.0, Injection	Sal	B200E	08/84→07/86		Not Incl. Control Unit, For Vehicles With Distributor	1	3	U1012	48092
400 Series 440									
1.6		B16F	11/91→12/96		Incl. Control Unit, For Vehicles With Distributor	1	5	U1032	48143
1.7, Carburettor		B18KP	08/89→10/90		Not Incl. Control Unit, For Vehicles With Distributor	1	3	U1012	48092
1.7, Carburettor Catalyst		B18KP	08/89→12/91		Not Incl. Control Unit, For Vehicles With Distributor	1	3	U1012	48092
1.7, Injection		B18EP	12/88→10/90		Not Incl. Control Unit, For Vehicles With Distributor	1	3	U1012	48092
1.7, Injection Catalyst		B18FP	08/89→12/92		Not Incl. Control Unit, For Vehicles With Distributor	1	3	U1012	48092
1.8, Automatic		B18FP	10/91→08/94		Not Incl. Control Unit, For Vehicles With Distributor	1	3	U1012	48092
1.8, Manual		B18U	10/91→08/94		Not Incl. Control Unit, For Vehicles With Distributor	1	3	U1012	48092
1.8, Manual or Automatic		B18U	08/94→07/96		Not Incl. Control Unit, For Vehicles With Distributor	1	3	U1012	48092
2.0		B20F	09/92→07/95		Not Incl. Control Unit, For Vehicles With Distributor	1	3	U1012	48092
400 Series 460									
1.6		B16F	09/93→07/96		Incl. Control Unit, For Vehicles With Distributor	1	5	U1032	48143

LITRE / MODEL	BODY	ENGINE TYPE	DATE	ADDITIONAL INFORMATION	FITMENT INFORMATION	NO. OF COILS	NO. OF PINS	PART NO.	STOCK NO.
VOLVO (continued)									
400 Series 460									
1.7, Carburettor Catalyst		B18KP	04/90→12/91		Not Incl. Control Unit, For Vehicles With Distributor	1	3	U1012	48092
1.7, Injection Catalyst		B18EP	04/90→12/91		Not Incl. Control Unit, For Vehicles With Distributor	1	3	U1012	48092
1.8, Automatic		B18EP	10/91→07/92		Not Incl. Control Unit, For Vehicles With Distributor	1	3	U1012	48092
1.8, Manual		B18U	10/91→08/94		Incl. Control Unit, For Vehicles With Distributor	1	5	U1032	48143
1.8, Manual or Automatic		B18U	08/94→07/96		Incl. Control Unit, For Vehicles With Distributor	1	5	U1032	48143
2.0		B20F	09/92→07/95		Not Incl. Control Unit, For Vehicles With Distributor	1	3	U1012	48092
400 Series 480									
1.7, Injection		B18E	06/87→07/88		Not Incl. Control Unit, For Vehicles With Distributor	1	3	U1012	48092
1.7, Injection Catalyst		B18EP	08/89→07/96		Not Incl. Control Unit, For Vehicles With Distributor	1	3	U1012	48092
2.0		B20F	09/92→09/95		Incl. Control Unit, For Vehicles With Distributor	1	5	U1032	48143
700 Series 740									
2.3, Carburettor	Est	B230K	10/85→07/88		For Vehicles With Distributor	1	2	U1076	48339
2.3, Carburettor	Sal	B23A, B230F, B230K	08/86→12/87		For Vehicles With Distributor	1	2	U1076	48339
2.3, Injection	Est	B230E	10/85→07/88		For Vehicles With Distributor	1	2	U1076	48339
2.3, Injection	Sal	B230E, B230FB	10/84→07/90		For Vehicles With Distributor	1	2	U1076	48339
800 Series 850									
2.0	Est		03/93→10/96		Incl. Control Unit, For Vehicles With Distributor	1	4	U1035	48156
2.0	Est, Sal	B5202S	01/95→12/96		Incl. Control Unit, For Vehicles With Distributor	1	4	U1035	48156
2.0	Sal		06/92→10/96		Incl. Control Unit, For Vehicles With Distributor	1	4	U1035	48156
2.3, R	Est, Sal	B5234T4	11/95→12/96		Incl. Control Unit, For Vehicles With Distributor	1	4	U1035	48156
2.3, T5	Est	B5234FT	08/94→12/96		Incl. Control Unit, For Vehicles With Distributor	1	4	U1035	48156
2.3, T5	Sal	B5234FT	08/94→07/96		Incl. Control Unit, For Vehicles With Distributor	1	4	U1035	48156
2.3, T-5R	Est, Sal		10/94→05/95		Incl. Control Unit, For Vehicles With Distributor	1	4	U1035	48156
2.3, Turbo	Est, Sal	B5234FT	09/93→08/94		Incl. Control Unit, For Vehicles With Distributor	1	4	U1035	48156
2.5	Est	B5252S	08/94→12/96		Incl. Control Unit, For Vehicles With Distributor	1	4	U1035	48156
2.5	Est	B5254S	03/93→12/96		Incl. Control Unit, For Vehicles With Distributor	1	4	U1035	48156
2.5	Est	B5254T	07/96→12/96		Incl. Control Unit, For Vehicles With Distributor	1	4	U1035	48156
2.5	Sal	B5254S	06/92→12/96		Incl. Control Unit, For Vehicles With Distributor	1	4	U1035	48156
900 Series 940									
2.3, L P Turbo	Est	B230FK	02/95→03/98			1	2	U1071	48308
2.3, L P Turbo	Sal	B230FK	10/95→12/97			1	2	U1071	48308
2.3, Turbo	Est	B230FT	08/94→03/96			1	2	U1071	48308
900 Series 960									
3.0	Est	B6304F, B6304S	09/94→12/96			6	2	U5066	48237
3.0	Est, Sal	B6304F, B6304S	09/90→07/94			6	2	U5066	48237
3.0	Sal	B6304F, B6304S	07/94→12/96			6	2	U5066	48237
C30 (06→)									
1.6		B4164S3	11/06→12/10			1	3	U2008	48027
1.8		B4184S11	11/06→12/10			4	2	U5019	48063
1.8, FlexiFuel		B4184S8	07/07→12/10			4	2	U5019	48063
2.0		B4204S3	11/06→			4	2	U5019	48063

LITRE / MODEL	BODY	ENGINE TYPE	DATE	ADDITIONAL INFORMATION	FITMENT INFORMATION	NO. OF COILS	NO. OF PINS	PART NO.	STOCK NO.
VOLVO (continued)									
C30 (06→)									
2.4		B5244S4	11/06→08/08	Grey Connector housing		5	4	U5037	48140
2.5, T5		B5254T3	11/06→03/08	Grey Connector housing		5	4	U5037	48140
2.5, T5		B5254T7	12/07→	Grey Connector housing		5	4	U5037	48140
C70 (97→02)									
2.0, T		B5204T4	03/00→09/02	Black Connector Housing		5	4	U5033	48127
2.3, T5		B5234T3	06/97→07/98		Incl. Control Unit, For Vehicles With Distributor	1	4	U1035	48156
2.3, T5		B5234T3	08/98→09/02	Black Connector Housing		5	4	U5033	48127
2.4		B5244S, B5254S	05/99→12/99	Black Connector Housing		5	4	U5033	48127
2.4, T		B5244T	04/99→09/00	Black Connector Housing		5	4	U5033	48127
2.4, T		B5254T	04/99→09/02	Grey Connector housing		5	4	U5037	48140
2.5T		B5244T	04/98→04/99	Black Connector Housing		5	4	U5033	48127
2.5T		B5254T	04/98→04/99	Grey Connector housing		5	4	U5037	48140
C70 (97→06)									
2.0, T		B5204T4	03/00→10/05	Black Connector Housing		5	4	U5033	48127
2.3, T5		B5234T3	04/99→11/02	Black Connector Housing		5	4	U5033	48127
2.3, T5		B5234T9	11/02→10/05	Black Connector Housing		5	4	U5033	48127
2.4, T		B5244T	04/99→09/00	Black Connector Housing		5	4	U5033	48127
2.4, T		B5254T	04/99→12/02	Grey Connector housing		5	4	U5037	48140
C70 (06→)									
2.4		B5244S4	03/06→12/10	Grey Connector housing		5	4	U5037	48140
2.5, T5		B5254T3	03/06→12/07	Grey Connector housing		5	4	U5037	48140
2.5, T5		B5254T7	08/07→	Grey Connector housing		5	4	U5037	48140
S40 (96→00)									
1.6		B4164S	04/97→04/99		For Cyl.: 2, 3, White Connector Housing	1	3	U3007	48058
1.6		B4164S	04/97→04/99		For Cyl.: 1, 4, Black Connector Housing	1	3	U3009	48068
1.6		B4164S2	04/99→08/99		For Cyl.: 2, 3, White Connector Housing	1	3	U3007	48058
1.6		B4164S2	04/99→08/99		For Cyl.: 1, 4, Black Connector Housing	1	3	U3009	48068
1.6		B4164S2	09/99→05/00			2	2	U4009	48171
1.8		B4184S, B4184S3	03/96→04/99		For Cyl.: 2, 3, White Connector Housing	1	3	U3007	48058
1.8		B4184S, B4184S3	03/96→04/99		For Cyl.: 1, 4, Black Connector Housing	1	3	U3009	48068
1.8		B4184S2, B4184S9	04/99→08/99		For Cyl.: 2, 3, White Connector Housing	1	3	U3007	48058
1.8		B4184S2, B4184S9	04/99→08/99		For Cyl.: 1, 4, Black Connector Housing	1	3	U3009	48068
1.8		B4184S2, B4184S9	09/99→05/00			2	2	U4009	48171
1.8		B4184SM	04/98→05/00			4	3	U4012	48210
1.9, T4		B4194T, B4194T2	06/97→05/00			2	2	U4009	48171
2.0		B4204S	03/96→08/99		For Cyl.: 2, 3, White Connector Housing	1	3	U3007	48058
2.0		B4204S	03/96→08/99		For Cyl.: 1, 4, Black Connector Housing	1	3	U3009	48068
2.0, Turbo		B4204T	10/97→05/00			2	2	U4009	48171
S40 (00→04)									
1.6		B4164S2	05/00→12/03			2	2	U4009	48171
1.8		B4184S2, B4184S9	05/00→12/03			2	2	U4009	48171
1.8, Dual Fuel		B4184S2, B4184S9	05/00→12/03			2	2	U4009	48171
1.8, i		B4184SJ	06/01→12/03			4	3	U4012	48210
1.9, T4		B4204T5	07/00→05/03			2	2	U4009	48171
2.0		B4204S, B4204S2	05/00→12/03			2	2	U4009	48171
2.0, Turbo		B4204T3	07/00→12/03			2	2	U4009	48171
S40 (04→13)									
1.6		B4164S3	01/05→03/12	To Ch. No.: 106166		1	3	U2001	48001
1.6		B4164S3	01/05→03/12	From Ch. No.: 106167		1	3	U2008	48027

LITRE / MODEL	BODY	ENGINE TYPE	DATE	ADDITIONAL INFORMATION	FITMENT INFORMATION	NO. OF COILS	NO. OF PINS	PART NO.	STOCK NO.
VOLVO (continued)									
S40 (04→13)									
1.8		B4184S11	05/04→12/10			4	2	U5019	48063
1.8, FlexiFuel		B4184S8	07/07→12/10			4	2	U5019	48063
2.0		B4204S3	10/06→05/13			4	2	U5019	48063
2.4, i		B5244S	02/04→12/08	Grey Connector housing		5	4	U5037	48140
2.5, T5		B5254T3	02/04→06/07	Grey Connector housing		5	4	U5037	48140
2.5, T5		B5254T7	05/07→03/12	Grey Connector housing		5	4	U5037	48140
S60 (00→10)									
2.0, Turbo		B5204T5	08/04→04/10	Grey Connector housing		5	4	U5037	48140
2.0, Turbo		B5204T5	09/01→07/04	Black Connector Housing		5	4	U5033	48127
2.3, T5		B5234T3	11/00→03/04	Black Connector Housing		5	4	U5033	48127
2.4, CNG Dual fuel		B5244SG2	06/02→12/07	Black Connector Housing		5	4	U5033	48127
2.4, LPG Dual Fuel		B5244SG2	06/02→05/05	Black Connector Housing		5	4	U5033	48127
2.4, T5		B5244T5	05/04→04/08	Grey Connector housing		5	4	U5037	48140
2.4, Turbo		B5244T3	11/00→07/03	Black Connector Housing		5	4	U5033	48127
2.5, R		B5254T4	06/03→07/07	Grey Connector housing		5	4	U5037	48140
2.5, T		B5254T2	02/04→04/08	Black Connector Housing		5	4	U5033	48127
S60 (10→)									
3.0		B6304T2, B6304T4	05/10→			6	4	U5149	48399
S70 (96→99)									
2.0		B5202S	01/97→07/98		Incl. Control Unit, For Vehicles With Distributor	1	4	U1035	48156
2.0		B5202S	08/98→04/99	Black Connector Housing		5	4	U5033	48127
2.3, R Automatic		B5234T3	06/97→07/98		Incl. Control Unit, For Vehicles With Distributor	1	4	U1035	48156
2.3, R Automatic		B5234T3	06/97→07/98	Black Connector Housing		5	4	U5033	48127
2.3, R Manual		B5234FT+	06/97→07/98		Incl. Control Unit, For Vehicles With Distributor	1	4	U1035	48156
2.3, T5		B5234T3	01/97→12/99		Incl. Control Unit, For Vehicles With Distributor	1	4	U1035	48156
2.3, T5		B5234T3	01/97→12/99	Black Connector Housing		5	4	U5033	48127
2.4		B5244S, B5254S	04/99→12/99		Incl. Control Unit, For Vehicles With Distributor	1	4	U1035	48156
2.4		B5244S, B5254S	04/99→12/99	Black Connector Housing		5	4	U5033	48127
2.4		B5244S2, B5244SG	08/99→12/99		Incl. Control Unit, For Vehicles With Distributor	1	4	U1035	48156
2.4		B5244S2, B5244SG	08/99→12/99	Black Connector Housing		5	4	U5033	48127
2.4, Dual Fuel		B5244S2, B5244SG	08/99→12/99		Incl. Control Unit, For Vehicles With Distributor	1	4	U1035	48156
2.4, Dual Fuel		B5244S2, B5244SG	08/99→12/99	Black Connector Housing		5	4	U5033	48127
2.4, T		B5244S, B5254S	04/99→12/99		Incl. Control Unit, For Vehicles With Distributor	1	4	U1035	48156
2.4, T		B5244S, B5254S	04/99→12/99	Black Connector Housing		5	4	U5033	48127
2.5		B5252S	01/97→07/98		Incl. Control Unit, For Vehicles With Distributor	1	4	U1035	48156
2.5		B5252S	08/98→01/99	Black Connector Housing		5	4	U5033	48127
2.5		B5254S	06/98→04/99	Black Connector Housing		5	4	U5033	48127
2.5T		B5244T, B5254T	01/97→07/98		Incl. Control Unit, For Vehicles With Distributor	1	4	U1035	48156
2.5T		B5244T, B5254T	08/98→04/99	Black Connector Housing		5	4	U5033	48127
S80 (98→06)									
2.0, T		B5204T5	05/03→07/06	Black Connector Housing		5	4	U5033	48127
2.0, T		B5204T5	05/03→07/06	Grey Connector housing		5	4	U5037	48140
2.4		B5244S	01/99→07/06	Black Connector Housing		5	4	U5033	48127
2.4		B5244S2	01/99→07/06	Black Connector Housing		5	4	U5033	48127
2.4, CNG Dual fuel		B5244SG2	09/01→05/05	Black Connector Housing		5	4	U5033	48127
2.4, LPG Dual Fuel		B5244SG2	09/01→05/05	Black Connector Housing		5	4	U5033	48127
2.4, T		B5244T3	03/02→08/03	Black Connector Housing		5	4	U5033	48127
2.5, T		B5254T2	04/03→07/06	Black Connector Housing		5	4	U5033	48127
2.5, T		B5254T2	04/03→07/06	Grey Connector housing		5	4	U5037	48140
2.8, T6		B6284T	05/98→12/01	Black Connector Housing		6	4	U5033	48127

LITRE / MODEL	BODY	ENGINE TYPE	DATE	ADDITIONAL INFORMATION	FITMENT INFORMATION	NO. OF COILS	NO. OF PINS	PART NO.	STOCK NO.
VOLVO (continued)									
S80 (98→06)									
2.9		B6294S, B6304S3	04/99→06/05	Black Connector Housing		6	4	U5033	48127
2.9		B6304S3	05/98→04/99	Black Connector Housing		6	4	U5033	48127
2.9, T6		B6294T	12/01→07/06	Black Connector Housing		6	4	U5033	48127
S80 (06→)									
2.0		B4204S3	01/08→04/10			4	2	U5019	48063
2.0, FlexiFuel		B4204S4	01/08→12/10			4	2	U5019	48063
2.5, FlexiFuel		B5254T11	01/10→12/10	Grey Connector housing		5	4	U5037	48140
2.5, FlexiFuel		B5254T8	05/08→04/10	Grey Connector housing		5	4	U5037	48140
2.5, T		B5254T10	01/10→12/10	Grey Connector housing		5	4	U5037	48140
2.5, T		B5254T6	10/06→04/10	Grey Connector housing		5	4	U5037	48140
3.0, T6		B6304T4	09/10→04/14			6	4	U5149	48399
3.2		B6324S	03/07→04/08			6	4	U5149	48399
3.2		B6324S	07/06→04/10			6	4	U5149	48399
S90 (96→98)									
3.0 Automatic		B6304G	01/97→05/98			6	2	U5066	48237
3.0 Automatic		B6304S2	01/97→05/98			6	2	U5066	48237
3.0 Manual		B6304S2	01/97→05/98			6	2	U5066	48237
V40 (96→00)									
1.6		B4164S	09/98→04/99		For Cyl.: 2, 3, White Connector Housing	1	3	U3007	48058
1.6		B4164S	09/98→04/99		For Cyl.: 1, 4, Black Connector Housing	1	3	U3009	48068
1.6		B4164S2	04/99→05/00			2	2	U4009	48171
1.8		B4184S, B4184S3	03/96→04/99		For Cyl.: 2, 3, White Connector Housing	1	3	U3007	48058
1.8		B4184S, B4184S3	03/96→04/99		For Cyl.: 1, 4, Black Connector Housing	1	3	U3009	48068
1.8		B4184S2, B4184S9	04/99→05/00			2	2	U4009	48171
1.8		B4184SM	04/98→05/00			4	3	U4012	48210
1.9, T4		B4194T	06/97→05/00			2	2	U4009	48171
2.0		B4204S	03/96→08/99		For Cyl.: 2, 3, White Connector Housing	1	3	U3007	48058
2.0		B4204S	03/96→08/99		For Cyl.: 1, 4, Black Connector Housing	1	3	U3009	48068
2.0, Turbo		B4204T	10/97→05/00			2	2	U4009	48171
V40 (00→04)									
1.6		B4164S2	05/00→06/04			2	2	U4009	48171
1.8		B4184S2, B4184S9	05/00→06/04			2	2	U4009	48171
1.8		B4184SJ	06/01→06/04			4	3	U4012	48210
1.8, Dual Fuel		B4184S2, B4184S9	05/00→06/04			2	2	U4009	48171
1.9, T4		B4204T5	07/00→05/03			2	2	U4009	48171
2.0		B4204S, B4204S2	05/00→06/04			2	2	U4009	48171
2.0, Turbo		B4204T2	05/00→06/01			2	2	U4009	48171
V50 (04→13)									
1.6		B4164S3	04/07→03/12	To Ch. No.: 105439		1	3	U2001	48001
1.6		B4164S3	04/07→03/12	From Ch. No.: 105440		1	3	U2008	48027
1.8		B4184S11	05/04→12/10			4	2	U5019	48063
1.8, FlexiFuel		B4184S8	07/07→12/10			4	2	U5019	48063
2.0		B4204S3	10/06→05/13			4	2	U5019	48063
2.4, i		B5244S	04/04→12/08	Grey Connector housing		5	4	U5037	48140
2.5, T5		B5254T3	04/04→06/07	Grey Connector housing		5	4	U5037	48140
2.5, T5		B5254T7	05/07→03/12	Grey Connector housing		5	4	U5037	48140
V60 (10→)									
3.0, T6		B6304T4	10/10→04/14			6	4	U5149	48399
V70 (96→00)									
2.0		B5202S	01/97→04/99		Incl. Control Unit, For Vehicles With Distributor	1	4	U1035	48156
2.3, R Automatic		B5234T3	06/97→04/99		Incl. Control Unit, For Vehicles With Distributor	1	4	U1035	48156

LITRE / MODEL	BODY	ENGINE TYPE	DATE	ADDITIONAL INFORMATION	FITMENT INFORMATION	NO. OF COILS	NO. OF PINS	PART NO.	STOCK NO.
VOLVO (continued)									
V70 (96→00)									
2.3, R Automatic		B5234T3	06/97→04/99	Black Connector Housing		5	4	U5033	48127
2.3, R Manual		B5234FT+	06/97→04/99		Incl. Control Unit, For Vehicles With Distributor	1	4	U1035	48156
2.3, R Manual		B5234FT+	06/97→04/99	Black Connector Housing		5	4	U5033	48127
2.3, T5		B5234T3	01/97→01/00		Incl. Control Unit, For Vehicles With Distributor	1	4	U1035	48156
2.3, T5		B5234T3	01/97→01/00	Black Connector Housing		5	4	U5033	48127
2.4		B5244S2, B5244SG2	08/99→04/00	Black Connector Housing		5	4	U5033	48127
2.4		B5244T, B5254T	04/99→04/00		Incl. Control Unit, For Vehicles With Distributor	1	4	U1035	48156
2.4		B5244T, B5254T	04/99→04/00	Black Connector Housing		5	4	U5033	48127
2.4		B5254S	04/99→04/00		Incl. Control Unit, For Vehicles With Distributor	1	4	U1035	48156
2.4		B5254S	04/99→04/00	Black Connector Housing		5	4	U5033	48127
2.4, Dual Fuel		B5244SG	08/99→03/00	Black Connector Housing		5	4	U5033	48127
2.4, L P Turbo		B5244S2, B5244SG2	08/99→04/00	Black Connector Housing		5	4	U5033	48127
2.4, T		B5254S	04/99→12/99		Incl. Control Unit, For Vehicles With Distributor	1	4	U1035	48156
2.4, T		B5254S	04/99→12/99	Black Connector Housing		5	4	U5033	48127
2.5		B5252FS	01/99→04/99		Incl. Control Unit, For Vehicles With Distributor	1	4	U1035	48156
2.5		B5252S	01/97→04/99		Incl. Control Unit, For Vehicles With Distributor	1	4	U1035	48156
2.5		B5254S	06/98→01/99	Black Connector Housing		5	4	U5033	48127
2.5T		B5244T, B5254T	01/97→05/00		Incl. Control Unit, For Vehicles With Distributor	1	4	U1035	48156
2.5T		B5244T, B5254T	01/97→05/00	Black Connector Housing		5	4	U5033	48127
V70 (00→07)									
2.0, T		B5204T5	05/03→06/07	Grey Connector housing		5	4	U5037	48140
2.3, T5		B5234T3, B5234T4	03/00→06/04		Incl. Control Unit, For Vehicles With Distributor	1	4	U1035	48156
2.3, T5		B5234T3, B5234T4	03/00→06/04	Black Connector Housing		5	4	U5033	48127
2.4		B5244S	03/00→08/07		Incl. Control Unit, For Vehicles With Distributor	1	4	U1035	48156
2.4		B5244S	03/00→08/07	Black Connector Housing		5	4	U5033	48127
2.4		B5244S2	03/00→06/07	Black Connector Housing		5	4	U5033	48127
2.4, CNG Dual fuel		B5244SG	09/01→08/07	Black Connector Housing		5	4	U5033	48127
2.4, Cross Country (XC)		B5244T3	06/00→09/02	Black Connector Housing		5	4	U5033	48127
2.4, LPG Dual Fuel		B5244SG	09/01→05/05	Black Connector Housing		5	4	U5033	48127
2.4, T		B5244T3	03/00→09/03	Black Connector Housing		5	4	U5033	48127
2.4, T5		B5244T5	05/04→08/07	Black Connector Housing		5	4	U5033	48127
2.4, T5		B5244T5	05/04→08/07	Grey Connector housing		5	4	U5037	48140
2.5, R		B5254T4	06/03→09/06	Black Connector Housing		5	4	U5033	48127
2.5, R		B5254T4	06/03→09/06	Grey Connector housing		5	4	U5037	48140
2.5, T		B5254T2	01/03→08/07	Black Connector Housing		5	4	U5033	48127
V70 (07→)									
2.0		B4204S3	10/07→04/10			4	2	U5019	48063
2.0, FlexiFuel		B4204S4	01/08→12/10			4	2	U5019	48063
2.5, FlexiFuel		B5254T11	10/09→12/10	Grey Connector housing		5	4	U5037	48140
2.5, FlexiFuel		B5254T8	05/08→04/10	Grey Connector housing		5	4	U5037	48140
2.5, T		B5254T10	01/10→12/10	Grey Connector housing		5	4	U5037	48140
2.5, T		B5254T6	09/07→04/10	Grey Connector housing		5	4	U5037	48140
3.0, T6		B6304T2	09/07→12/10			6	4	U5149	48399
3.0, T6		B6304T2, B6304T4	05/10→04/14			6	4	U5149	48399
3.2		B6324S	09/07→04/10			6	4	U5149	48399
V90 (96→98)									
3.0 Automatic		B6304G	01/97→12/98			6	2	U5066	48237
3.0 Automatic		B6304S2	01/97→12/98			6	2	U5066	48237
3.0 Manual		B6304S2	01/97→12/98			6	2	U5066	48237

LITRE / MODEL	BODY	ENGINE TYPE	DATE	ADDITIONAL INFORMATION	FITMENT INFORMATION	NO. OF COILS	NO. OF PINS	PART	STOCK
VOLVO (continued)									
XC60 (08→)									
3.0, T6		B6304T2, B6304T4	05/10→			6	4	U5149	48399
XC70 (02→07)									
2.5, T		B5254T2	01/03→08/07	Black Connector Housing		5	4	U5033	48127
XC70 (07→)									
3.0		B6304T2	06/09→12/10			6	4	U5149	48399
3.0		B6304T2, B6304T4	05/10→			6	4	U5149	48399
3.2		B6324S	09/07→12/09			6	4	U5149	48399
XC90 (02→)									
2.5, T		B5254T2	11/04→12/06	Black Connector Housing		5	4	U5033	48127
2.9, T6		B6294T	10/02→12/06	Black Connector Housing		6	4	U5033	48127
3.2		B6324S	11/06→12/10			6	4	U5149	48399

YUGO									
45, 65									
0.9, 45/45A		9A	03/83→12/91		For Vehicles With Distributor	1	2	U1079	48342
311, 313									
1.1		128A4	04/83→02/90		For Vehicles With Distributor	1	2	U1079	48342
511, 513									
1.1		128A4	04/83→08/90		For Vehicles With Distributor	1	2	U1079	48342

IGNITION COIL IMAGES

Part No.	Stock No.	No. of Pins	No. of Outlets	Additional Information
U1001	48000	3	1	Coupling Type M4, , Incl. Control Unit
				

Part No.	Stock No.	No. of Pins	No. of Outlets	Additional Information
U1006	48059	2	1	Coupling Type SAE, With Bracket
				

Part No.	Stock No.	No. of Pins	No. of Outlets	Additional Information
U1002	48029	4	1	Coupling Type SAE, With Bracket
				

Part No.	Stock No.	No. of Pins	No. of Outlets	Additional Information
U1007	48062	4	1	Coupling Type SAE, Oval Connector
				

Part No.	Stock No.	No. of Pins	No. of Outlets	Additional Information
U1003	48039	6	1	Incl. Control Unit
				

Part No.	Stock No.	No. of Pins	No. of Outlets	Additional Information
U1008	48064	4	1	Coupling Type DIN
				

Part No.	Stock No.	No. of Pins	No. of Outlets	Additional Information
U1004	48054	2	1	
				

Part No.	Stock No.	No. of Pins	No. of Outlets	Additional Information
U1009	48066	4	1	Coupling Type SAE, Angular Connector
				

Part No.	Stock No.	No. of Pins	No. of Outlets	Additional Information
U1005	48057	4	1	Coupling Type M4, With Bracket
				

Part No.	Stock No.	No. of Pins	No. of Outlets	Additional Information
U1010	48069	3	1	Coupling Type DIN
				

IGNITION COIL IMAGES

Part No.	Stock No.	No. of Pins	No. of Outlets	Additional Information
U1011	48090	3	1	Coupling Type SAE
				

Part No.	Stock No.	No. of Pins	No. of Outlets	Additional Information
U1016	48098	2	1	
				

Part No.	Stock No.	No. of Pins	No. of Outlets	Additional Information
U1012	48092	3	1	Screw Type, Coupling Type SAE, Does Not Incl. Control Unit
				

Part No.	Stock No.	No. of Pins	No. of Outlets	Additional Information
U1017	48099	2	1	
				

Part No.	Stock No.	No. of Pins	No. of Outlets	Additional Information
U1013	48093	2	1	Fitted Inside Dist.
				

Part No.	Stock No.	No. of Pins	No. of Outlets	Additional Information
U1018	48105	2	1	
				

Part No.	Stock No.	No. of Pins	No. of Outlets	Additional Information
U1014	48094	2	1	Fitted Inside Dist.
				

Part No.	Stock No.	No. of Pins	No. of Outlets	Additional Information
U1020	48111	2	1	
				

Part No.	Stock No.	No. of Pins	No. of Outlets	Additional Information
U1015	48097	2	1	
				

Part No.	Stock No.	No. of Pins	No. of Outlets	Additional Information
U1021	48112	3	1	
				

IGNITION COIL IMAGES

Part No.	Stock No.	No. of Pins	No. of Outlets	Additional Information
U1022	48113	2	1	With Bracket
				

Part No.	Stock No.	No. of Pins	No. of Outlets	Additional Information
U1027	48125	2	1	Coupling Type DIN
				

Part No.	Stock No.	No. of Pins	No. of Outlets	Additional Information
U1023	48115	2	1	
				

Part No.	Stock No.	No. of Pins	No. of Outlets	Additional Information
U1028	48129	2	1	Coupling Type DIN
				

Part No.	Stock No.	No. of Pins	No. of Outlets	Additional Information
U1024	48117	2	1	Oval Connector
				

Part No.	Stock No.	No. of Pins	No. of Outlets	Additional Information
U1029	48132	4	1	Coupling Type SAE, Oval Connector, With Bracket
				

Part No.	Stock No.	No. of Pins	No. of Outlets	Additional Information
U1025	48121	4	1	
				

Part No.	Stock No.	No. of Pins	No. of Outlets	Additional Information
U1030	48137	4	1	Coupling Type DIN
				

Part No.	Stock No.	No. of Pins	No. of Outlets	Additional Information
U1026	48123	3	1	Coupling Type SAE, Angular Connector, With Bracket
				

Part No.	Stock No.	No. of Pins	No. of Outlets	Additional Information
U1031	48141	4	1	Coupling Type SAE
				

IGNITION COIL IMAGES

Part No.	Stock No.	No. of Pins	No. of Outlets	Additional Information
U1032	48143	5	1	Coupling Type SAE, Incl. Control Unit
				

Part No.	Stock No.	No. of Pins	No. of Outlets	Additional Information
U1037	48176	2	1	With Bracket, Incl. Control Unit
				

Part No.	Stock No.	No. of Pins	No. of Outlets	Additional Information
U1033	48148	4	1	Not for Elec. Injection
				

Part No.	Stock No.	No. of Pins	No. of Outlets	Additional Information
U1038	48180	2	1	
				

Part No.	Stock No.	No. of Pins	No. of Outlets	Additional Information
U1034	48152	2	1	With Bracket
				

Part No.	Stock No.	No. of Pins	No. of Outlets	Additional Information
U1039	48181	3	1	
				

Part No.	Stock No.	No. of Pins	No. of Outlets	Additional Information
U1035	48156	4	1	Coupling Type M4, Incl. Control Unit
				

Part No.	Stock No.	No. of Pins	No. of Outlets	Additional Information
U1040	48182	2	1	
				

Part No.	Stock No.	No. of Pins	No. of Outlets	Additional Information
U1036	48158	2	1	Not for Elec. Injection
				

Part No.	Stock No.	No. of Pins	No. of Outlets	Additional Information
U1041	48186	4	1	Coupling Type DIN
				

IGNITION COIL IMAGES

Part No.	Stock No.	No. of Pins	No. of Outlets	Additional Information
U1043	48188	2	1	Fitted Outside Dist.
				

Part No.	Stock No.	No. of Pins	No. of Outlets	Additional Information
U1054	48217	4	1	
				

Part No.	Stock No.	No. of Pins	No. of Outlets	Additional Information
U1044	48191	4	1	Coupling Type SAE, With Bracket
				

Part No.	Stock No.	No. of Pins	No. of Outlets	Additional Information
U1056	48236	2	1	Push In, Coupling Type DIN
				

Part No.	Stock No.	No. of Pins	No. of Outlets	Additional Information
U1045	48198	2	1	With Bracket
				

Part No.	Stock No.	No. of Pins	No. of Outlets	Additional Information
U1059	48253	2	1	
				

Part No.	Stock No.	No. of Pins	No. of Outlets	Additional Information
U1047	48200	4	1	
				

Part No.	Stock No.	No. of Pins	No. of Outlets	Additional Information
U1061	48298	2	1	Screw In
				

Part No.	Stock No.	No. of Pins	No. of Outlets	Additional Information
U1050	48211	2	1	
				

Part No.	Stock No.	No. of Pins	No. of Outlets	Additional Information
U1062	48299	2	1	Push In, Coupling Type DIN
				

IGNITION COIL IMAGES

Part No.	Stock No.	No. of Pins	No. of Outlets	Additional Information
U1063	48300	2	1	LT - Ford Specific, Coupling Type DIN

Part No.	Stock No.	No. of Pins	No. of Outlets	Additional Information
U1069	48306	2	1	Coupling Type DIN

Part No.	Stock No.	No. of Pins	No. of Outlets	Additional Information
U1064	48301	2	1	LT - GM Specific

Part No.	Stock No.	No. of Pins	No. of Outlets	Additional Information
U1070	48307	2	1	

Part No.	Stock No.	No. of Pins	No. of Outlets	Additional Information
U1065	48302	2	1	Coupling Type DIN

Part No.	Stock No.	No. of Pins	No. of Outlets	Additional Information
U1071	48308	2	1	Coupling Type M4

Part No.	Stock No.	No. of Pins	No. of Outlets	Additional Information
U1066	48303	2	1	Coupling Type M4

Part No.	Stock No.	No. of Pins	No. of Outlets	Additional Information
U1072	48309	2	1	

Part No.	Stock No.	No. of Pins	No. of Outlets	Additional Information
U1068	48305	2	1	

Part No.	Stock No.	No. of Pins	No. of Outlets	Additional Information
U1073	48310	2	1	

IGNITION COIL IMAGES

Part No.	Stock No.	No. of Pins	No. of Outlets	Additional Information
U1074	48311	2	1	



Part No.	Stock No.	No. of Pins	No. of Outlets	Additional Information
U1079	48342	2	1	Coupling Type DIN



Part No.	Stock No.	No. of Pins	No. of Outlets	Additional Information
U1075	48324	4	1	



Part No.	Stock No.	No. of Pins	No. of Outlets	Additional Information
U1080	48343	2	1	Coupling Type M4



Part No.	Stock No.	No. of Pins	No. of Outlets	Additional Information
U1076	48339	2	1	Coupling Type DIN



Part No.	Stock No.	No. of Pins	No. of Outlets	Additional Information
U1081	48344	2	1	Coupling Type M4



Part No.	Stock No.	No. of Pins	No. of Outlets	Additional Information
U1077	48340	2	1	Connector Angle: 90 deg.



Part No.	Stock No.	No. of Pins	No. of Outlets	Additional Information
U1082	48345	2	1	Coupling Type M4



Part No.	Stock No.	No. of Pins	No. of Outlets	Additional Information
U1078	48341	2	1	Coupling Type DIN





Part No.	Stock No.	No. of Pins	No. of Outlets	Additional Information
U1083	48346	2	1	Coupling Type M4





IGNITION COIL IMAGES

Part No.	Stock No.	No. of Pins	No. of Outlets	Additional Information
U1084	48357	2	1	
				

Part No.	Stock No.	No. of Pins	No. of Outlets	Additional Information
U2003	48010	4	4	Coupling Type M4
				

Part No.	Stock No.	No. of Pins	No. of Outlets	Additional Information
U1085	48203	2	1	Coupling Type SAE
				

Part No.	Stock No.	No. of Pins	No. of Outlets	Additional Information
U2004	48012	4	4	Coupling Type M4, Incl. Control Unit
				

Part No.	Stock No.	No. of Pins	No. of Outlets	Additional Information
U1086	48204	2	1	Coupling Type SAE, Oval Connector, Does Not Incl. Control Unit
				

Part No.	Stock No.	No. of Pins	No. of Outlets	Additional Information
U2005	48021	3	4	Coupling Type DIN
				

Part No.	Stock No.	No. of Pins	No. of Outlets	Additional Information
U1091	48363	2	1	
				

Part No.	Stock No.	No. of Pins	No. of Outlets	Additional Information
U2006	48025	3	4	Coupling Type M4
				

Part No.	Stock No.	No. of Pins	No. of Outlets	Additional Information
U2001	48001	3	4	Coupling Type M4
				

Part No.	Stock No.	No. of Pins	No. of Outlets	Additional Information
U2007	48026	4	4	Coupling Type M4, Oval Connector
				

IGNITION COIL IMAGES

Part No.	Stock No.	No. of Pins	No. of Outlets	Additional Information
U2008	48027	3	4	
				

Part No.	Stock No.	No. of Pins	No. of Outlets	Additional Information
U2013	48049	6	6	With Bracket
				

Part No.	Stock No.	No. of Pins	No. of Outlets	Additional Information
U2009	48030	4	4	Coupling Type M4, Connector Angle: 90 deg.
				

Part No.	Stock No.	No. of Pins	No. of Outlets	Additional Information
U2014	48052	3	4	
				

Part No.	Stock No.	No. of Pins	No. of Outlets	Additional Information
U2010	48037	5	6	
				

Part No.	Stock No.	No. of Pins	No. of Outlets	Additional Information
U2015	48053	3	4	
				

Part No.	Stock No.	No. of Pins	No. of Outlets	Additional Information
U2011	48038	6	4	
				

Part No.	Stock No.	No. of Pins	No. of Outlets	Additional Information
U2016	48056	4	4	Connector Angle: 45 deg.
				

Part No.	Stock No.	No. of Pins	No. of Outlets	Additional Information
U2012	48044	3	4	Coupling Type M4
				

Part No.	Stock No.	No. of Pins	No. of Outlets	Additional Information
U2017	48067	4	4	Coupling Type M4, Connector Angle: 120 deg.
				

IGNITION COIL IMAGES

Part No.	Stock No.	No. of Pins	No. of Outlets	Additional Information
U2018	48070	4	4	Oval Connector
				

Part No.	Stock No.	No. of Pins	No. of Outlets	Additional Information
U2024	48087	5	6	Angular Connector, Incl. Control Unit
				

Part No.	Stock No.	No. of Pins	No. of Outlets	Additional Information
U2019	48078	4	4	Coupling Type M4, Angular Connector
				

Part No.	Stock No.	No. of Pins	No. of Outlets	Additional Information
U2025	48096	4	6	Vertical Primary Connection (Square), Angular Connector
				

Part No.	Stock No.	No. of Pins	No. of Outlets	Additional Information
U2020	48079	4	6	Vertical Primary Connection (Oval), For Vertical Fastening
				

Part No.	Stock No.	No. of Pins	No. of Outlets	Additional Information
U2026	48101	5	6	Oval Connector
				

Part No.	Stock No.	No. of Pins	No. of Outlets	Additional Information
U2021	48080	4	4	Coupling Type M4, Oval Connector
				

Part No.	Stock No.	No. of Pins	No. of Outlets	Additional Information
U2027	48106	4	6	Vertical Primary Connection (Oval)
				

Part No.	Stock No.	No. of Pins	No. of Outlets	Additional Information
U2023	48086	4	6	
				

Part No.	Stock No.	No. of Pins	No. of Outlets	Additional Information
U2028	48108	4	4	Without Ignition Cable (U6052 With Ignition Cable)
				

IGNITION COIL IMAGES

Part No.	Stock No.	No. of Pins	No. of Outlets	Additional Information
U2029	48110	4	6	For Horizontal Fastening
				

Part No.	Stock No.	No. of Pins	No. of Outlets	Additional Information
U2034	48153	4	3	Coupling Type SAE
				

Part No.	Stock No.	No. of Pins	No. of Outlets	Additional Information
U2030	48133	6	4	
				

Part No.	Stock No.	No. of Pins	No. of Outlets	Additional Information
U2035	48160	3	4	Coupling Type DIN, With Bracket
				

Part No.	Stock No.	No. of Pins	No. of Outlets	Additional Information
U2031	48142	3	4	Coupling Type M4, Oval Connector
				

Part No.	Stock No.	No. of Pins	No. of Outlets	Additional Information
U2036	48166	5	4	Coupling Type DIN, With Bracket
				

Part No.	Stock No.	No. of Pins	No. of Outlets	Additional Information
U2032	48145	4	4	
				

Part No.	Stock No.	No. of Pins	No. of Outlets	Additional Information
U2037	48167	3	4	With Bracket
				

Part No.	Stock No.	No. of Pins	No. of Outlets	Additional Information
U2033	48150	6	5	Incl. Spark Plug Connector
				

Part No.	Stock No.	No. of Pins	No. of Outlets	Additional Information
U2038	48169	6	4	With Ignition Cable
				

IGNITION COIL IMAGES

Part No.	Stock No.	No. of Pins	No. of Outlets	Additional Information
U2039	48170	3	4	Coupling Type DIN, With Bracket
				

Part No.	Stock No.	No. of Pins	No. of Outlets	Additional Information
U2044	48195	3	4	Coupling Type SAE, Four-Point Mounting
				

Part No.	Stock No.	No. of Pins	No. of Outlets	Additional Information
U2040	48173	3	4	Coupling Type DIN, With Bracket
				

Part No.	Stock No.	No. of Pins	No. of Outlets	Additional Information
U2045	48196	6	8	With Bracket
				

Part No.	Stock No.	No. of Pins	No. of Outlets	Additional Information
U2041	48185	3	4	Coupling Type SAE, Four-Point Mounting
				

Part No.	Stock No.	No. of Pins	No. of Outlets	Additional Information
U2046	48197	4	6	
				

Part No.	Stock No.	No. of Pins	No. of Outlets	Additional Information
U2042	48189	4	4	Coupling Type DIN, With Bracket
				

Part No.	Stock No.	No. of Pins	No. of Outlets	Additional Information
U2047	48202	3	4	Connector Colour: Grey, Coupling Type DIN
				

Part No.	Stock No.	No. of Pins	No. of Outlets	Additional Information
U2043	48193	4	6	Horizontal Primary Connection (Square), Angular Connector
				

Part No.	Stock No.	No. of Pins	No. of Outlets	Additional Information
U2048	48209	2	4	With Bracket
				

IGNITION COIL IMAGES

Part No.	Stock No.	No. of Pins	No. of Outlets	Additional Information
U2049	48220	4	6	Coupling Type SAE, For Vertical Fastening, Square Connector
				

Part No.	Stock No.	No. of Pins	No. of Outlets	Additional Information
U2054	48251	7	6	
				

Part No.	Stock No.	No. of Pins	No. of Outlets	Additional Information
U2050	48224	4	4	With Bracket
				

Part No.	Stock No.	No. of Pins	No. of Outlets	Additional Information
U2055	48254	4	4	Coupling Type SAE, Three-Point Mounting, Oval Connector
				

Part No.	Stock No.	No. of Pins	No. of Outlets	Additional Information
U2051	48230	3	4	Coupling Type DIN, With Bracket
				

Part No.	Stock No.	No. of Pins	No. of Outlets	Additional Information
U2056	48255	3	4	Coupling Type SAE, Four-Point Mounting
				

Part No.	Stock No.	No. of Pins	No. of Outlets	Additional Information
U2052	48249	4	6	With Bracket
				

Part No.	Stock No.	No. of Pins	No. of Outlets	Additional Information
U2057	48260	4	6	Coupling Type SAE, For Horizontal Fastening, Oval Connector
				

Part No.	Stock No.	No. of Pins	No. of Outlets	Additional Information
U2053	48250	3	4	With Bracket
				

Part No.	Stock No.	No. of Pins	No. of Outlets	Additional Information
U2058	48261	4	6	Coupling Type SAE, For Vertical Fastening, Oval Connector
				

IGNITION COIL IMAGES

Part No.	Stock No.	No. of Pins	No. of Outlets	Additional Information
U2059	48272	3	4	
				

Part No.	Stock No.	No. of Pins	No. of Outlets	Additional Information
U2064	48296	3	4	With Bracket
				

Part No.	Stock No.	No. of Pins	No. of Outlets	Additional Information
U2060	48287	5	4	With Bracket
				

Part No.	Stock No.	No. of Pins	No. of Outlets	Additional Information
U2066	48315	3	4	Triangular Connector, With Bracket
				

Part No.	Stock No.	No. of Pins	No. of Outlets	Additional Information
U2061	48288	5	4	With Bracket
				

Part No.	Stock No.	No. of Pins	No. of Outlets	Additional Information
U2068	48325	4	6	Oval Connector
				

Part No.	Stock No.	No. of Pins	No. of Outlets	Additional Information
U2062	48289	4	4	
				

Part No.	Stock No.	No. of Pins	No. of Outlets	Additional Information
U2073	48368	3	4	
				

Part No.	Stock No.	No. of Pins	No. of Outlets	Additional Information
U2063	48290	3	4	With Bracket
				

Part No.	Stock No.	No. of Pins	No. of Outlets	Additional Information
U2074	48369	3	4	
				

IGNITION COIL IMAGES

Part No.	Stock No.	No. of Pins	No. of Outlets	Additional Information
U2075	48370	3	4	
				

Part No.	Stock No.	No. of Pins	No. of Outlets	Additional Information
U3003	48020	3	2	Connector Colour: White, Coupling Type M4
				

Part No.	Stock No.	No. of Pins	No. of Outlets	Additional Information
U2076	48371	4	6	
				

Part No.	Stock No.	No. of Pins	No. of Outlets	Additional Information
U3004	48024	3	2	Coupling Type DIN
				

Part No.	Stock No.	No. of Pins	No. of Outlets	Additional Information
U2077	48372	4	6	
				

Part No.	Stock No.	No. of Pins	No. of Outlets	Additional Information
U3005	48028	3	2	Connector Colour: Black, Coupling Type SAE, Angular Connector
				

Part No.	Stock No.	No. of Pins	No. of Outlets	Additional Information
U3001	48013	2	2	Coupling Type DIN
				

Part No.	Stock No.	No. of Pins	No. of Outlets	Additional Information
U3006	48050	2	2	Coupling Type M4
				

Part No.	Stock No.	No. of Pins	No. of Outlets	Additional Information
U3002	48019	3	2	Connector Colour: Black, Coupling Type M4
				

Part No.	Stock No.	No. of Pins	No. of Outlets	Additional Information
U3007	48058	3	2	Connector Colour: White, Coupling Type SAE
				

IGNITION COIL IMAGES

Part No.	Stock No.	No. of Pins	No. of Outlets	Additional Information
U3008	48060	3	2	Connector Colour: Black, Coupling Type M4
				

Part No.	Stock No.	No. of Pins	No. of Outlets	Additional Information
U3017	48233	2	2	Coupling Type SAE
				

Part No.	Stock No.	No. of Pins	No. of Outlets	Additional Information
U3009	48068	3	2	Connector Colour: Black, Coupling Type SAE
				

Part No.	Stock No.	No. of Pins	No. of Outlets	Additional Information
U3018	48280	4	2	
				

Part No.	Stock No.	No. of Pins	No. of Outlets	Additional Information
U3010	48085	4	2	
				

Part No.	Stock No.	No. of Pins	No. of Outlets	Additional Information
U3020	48374	2	2	
				

Part No.	Stock No.	No. of Pins	No. of Outlets	Additional Information
U3015	48218	2	2	Coupling Type SAE
				

Part No.	Stock No.	No. of Pins	No. of Outlets	Additional Information
U4001	48055	2	2	Connector Colour: Black
				

Part No.	Stock No.	No. of Pins	No. of Outlets	Additional Information
U3016	48228	2	2	Connector Colour: Black
				

Part No.	Stock No.	No. of Pins	No. of Outlets	Additional Information
U4002	48100	2	2	Connector Colour: Red
				

IGNITION COIL IMAGES

Part No.	Stock No.	No. of Pins	No. of Outlets	Additional Information
U4003	48103	2	2	Without Spark Plug Connector, Angular Connector
				

Part No.	Stock No.	No. of Pins	No. of Outlets	Additional Information
U4008	48157	3	2	
				

Part No.	Stock No.	No. of Pins	No. of Outlets	Additional Information
U4004	48104	2	2	Without Spark Plug Connector, Oval Connector
				

Part No.	Stock No.	No. of Pins	No. of Outlets	Additional Information
U4009	48171	2	2	Coupling Type M4
				

Part No.	Stock No.	No. of Pins	No. of Outlets	Additional Information
U4005	48119	2	2	
				

Part No.	Stock No.	No. of Pins	No. of Outlets	Additional Information
U4010	48183	3	2	
				

Part No.	Stock No.	No. of Pins	No. of Outlets	Additional Information
U4006	48134	3	2	
				

Part No.	Stock No.	No. of Pins	No. of Outlets	Additional Information
U4011	48208	3	2	Incl. Spark Plug Connector
				

Part No.	Stock No.	No. of Pins	No. of Outlets	Additional Information
U4007	48149	2	2	Without Spark Plug Connector, Oval Connector
				

Part No.	Stock No.	No. of Pins	No. of Outlets	Additional Information
U4012	48210	3	2	
				

IGNITION COIL IMAGES

Part No.	Stock No.	No. of Pins	No. of Outlets	Additional Information
U4013	48223	3	2	Incl. Spark Plug Connector
				

Part No.	Stock No.	No. of Pins	No. of Outlets	Additional Information
U4020	48291	2	2	
				

Part No.	Stock No.	No. of Pins	No. of Outlets	Additional Information
U4014	48225	3	2	
				

Part No.	Stock No.	No. of Pins	No. of Outlets	Additional Information
U4021	48294	2	2	Connector Colour: Blue
				

Part No.	Stock No.	No. of Pins	No. of Outlets	Additional Information
U4015	48242	3	2	Incl. Spark Plug Connector
				

Part No.	Stock No.	No. of Pins	No. of Outlets	Additional Information
U4022	48313	3	2	Coupling Type M4
				

Part No.	Stock No.	No. of Pins	No. of Outlets	Additional Information
U4017	48264	2	2	
				

Part No.	Stock No.	No. of Pins	No. of Outlets	Additional Information
U4023	48314	3	2	Coupling Type DIN
				

Part No.	Stock No.	No. of Pins	No. of Outlets	Additional Information
U4019	48270	2	2	
				

Part No.	Stock No.	No. of Pins	No. of Outlets	Additional Information
U4024	48326	2	2	Coupling Type M4
				

IGNITION COIL IMAGES

Part No.	Stock No.	No. of Pins	No. of Outlets	Additional Information
U4026	48018	1	2	Incl. Spark Plug Connector
				

Part No.	Stock No.	No. of Pins	No. of Outlets	Additional Information
U5002	48003	4	1	
				

Part No.	Stock No.	No. of Pins	No. of Outlets	Additional Information
U4027	48375	3	2	
				

Part No.	Stock No.	No. of Pins	No. of Outlets	Additional Information
U5003	48005	4	1	
				

Part No.	Stock No.	No. of Pins	No. of Outlets	Additional Information
U4028	48376	3	2	
				

Part No.	Stock No.	No. of Pins	No. of Outlets	Additional Information
U5004	48008	3	1	Incl. Spark Plug Connector
				

Part No.	Stock No.	No. of Pins	No. of Outlets	Additional Information
U4031	48379	3	2	
				

Part No.	Stock No.	No. of Pins	No. of Outlets	Additional Information
U5005	48009	3	1	Incl. Spark Plug Connector
				

Part No.	Stock No.	No. of Pins	No. of Outlets	Additional Information
U5001	48002	2	1	
				

Part No.	Stock No.	No. of Pins	No. of Outlets	Additional Information
U5006	48015	4	1	
				

IGNITION COIL IMAGES

Part No.	Stock No.	No. of Pins	No. of Outlets	Additional Information
U5008	48031	2	1	
				

Part No.	Stock No.	No. of Pins	No. of Outlets	Additional Information
U5013	48040	4	1	Connector Colour: Red
				

Part No.	Stock No.	No. of Pins	No. of Outlets	Additional Information
U5009	48033	3	1	Triangular Connector
				

Part No.	Stock No.	No. of Pins	No. of Outlets	Additional Information
U5014	48041	4	1	Connector Colour: Red
				

Part No.	Stock No.	No. of Pins	No. of Outlets	Additional Information
U5010	48034	3	1	
				

Part No.	Stock No.	No. of Pins	No. of Outlets	Additional Information
U5015	48042	4	1	
				

Part No.	Stock No.	No. of Pins	No. of Outlets	Additional Information
U5011	48035	4	1	
				

Part No.	Stock No.	No. of Pins	No. of Outlets	Additional Information
U5016	48046	3	1	Incl. Spark Plug Connector
				

Part No.	Stock No.	No. of Pins	No. of Outlets	Additional Information
U5012	48036	3	1	Incl. Spark Plug Connector
				

Part No.	Stock No.	No. of Pins	No. of Outlets	Additional Information
U5017	48047	4	1	
				

IGNITION COIL IMAGES

Part No.	Stock No.	No. of Pins	No. of Outlets	Additional Information
U5018	48061	3	1	Connector Colour: Black
				

Part No.	Stock No.	No. of Pins	No. of Outlets	Additional Information
U5024	48088	4	1	Connector Colour: Red
				

Part No.	Stock No.	No. of Pins	No. of Outlets	Additional Information
U5019	48063	2	1	Incl. Spark Plug Connector
				

Part No.	Stock No.	No. of Pins	No. of Outlets	Additional Information
U5025	48089	3	1	
				

Part No.	Stock No.	No. of Pins	No. of Outlets	Additional Information
U5020	48065	4	1	
				

Part No.	Stock No.	No. of Pins	No. of Outlets	Additional Information
U5026	48091	3	1	
				

Part No.	Stock No.	No. of Pins	No. of Outlets	Additional Information
U5021	48073	2	1	Incl. Spark Plug Connector
				

Part No.	Stock No.	No. of Pins	No. of Outlets	Additional Information
U5027	48095	4	1	
				

Part No.	Stock No.	No. of Pins	No. of Outlets	Additional Information
U5022	48082	4	1	
				

Part No.	Stock No.	No. of Pins	No. of Outlets	Additional Information
U5028	48102	3	1	Incl. Spark Plug Connector
				

IGNITION COIL IMAGES

Part No.	Stock No.	No. of Pins	No. of Outlets	Additional Information
U5029	48107	4	1	
				

Part No.	Stock No.	No. of Pins	No. of Outlets	Additional Information
U5034	48131	3	1	Incl. Spark Plug Connector
				

Part No.	Stock No.	No. of Pins	No. of Outlets	Additional Information
U5030	48116	3	1	
				

Part No.	Stock No.	No. of Pins	No. of Outlets	Additional Information
U5035	48136	3	1	
				

Part No.	Stock No.	No. of Pins	No. of Outlets	Additional Information
U5031	48120	2	1	Incl. Spark Plug Connector
				

Part No.	Stock No.	No. of Pins	No. of Outlets	Additional Information
U5036	48139	3	1	
				

Part No.	Stock No.	No. of Pins	No. of Outlets	Additional Information
U5032	48122	3	1	
				

Part No.	Stock No.	No. of Pins	No. of Outlets	Additional Information
U5037	48140	4	1	Connector Colour: Grey
				

Part No.	Stock No.	No. of Pins	No. of Outlets	Additional Information
U5033	48127	4	1	Connector Colour: Black
				

Part No.	Stock No.	No. of Pins	No. of Outlets	Additional Information
U5038	48144	2	1	Incl. Spark Plug Connector
				

IGNITION COIL IMAGES

Part No.	Stock No.	No. of Pins	No. of Outlets	Additional Information
U5039	48147	3	1	
				

Part No.	Stock No.	No. of Pins	No. of Outlets	Additional Information
U5044	48163	3	1	Incl. Spark Plug Connector
				

Part No.	Stock No.	No. of Pins	No. of Outlets	Additional Information
U5040	48154	3	1	Incl. Spark Plug Connector
				

Part No.	Stock No.	No. of Pins	No. of Outlets	Additional Information
U5045	48164	2	1	
				

Part No.	Stock No.	No. of Pins	No. of Outlets	Additional Information
U5041	48155	3	1	Incl. Spark Plug Connector
				

Part No.	Stock No.	No. of Pins	No. of Outlets	Additional Information
U5046	48165	4	1	
				

Part No.	Stock No.	No. of Pins	No. of Outlets	Additional Information
U5042	48161	4	1	
				

Part No.	Stock No.	No. of Pins	No. of Outlets	Additional Information
U5047	48168	3	1	Incl. Spark Plug Connector, Angular Connector
				

Part No.	Stock No.	No. of Pins	No. of Outlets	Additional Information
U5043	48162	3	1	
				

Part No.	Stock No.	No. of Pins	No. of Outlets	Additional Information
U5048	48172	3	1	
				

IGNITION COIL IMAGES

Part No.	Stock No.	No. of Pins	No. of Outlets	Additional Information
U5049	48174	4	1	
				

Part No.	Stock No.	No. of Pins	No. of Outlets	Additional Information
U5054	48201	3	1	
				

Part No.	Stock No.	No. of Pins	No. of Outlets	Additional Information
U5050	48177	3	1	
				

Part No.	Stock No.	No. of Pins	No. of Outlets	Additional Information
U5055	48206	3	1	
				

Part No.	Stock No.	No. of Pins	No. of Outlets	Additional Information
U5051	48179	3	1	
				

Part No.	Stock No.	No. of Pins	No. of Outlets	Additional Information
U5056	48207	3	1	
				

Part No.	Stock No.	No. of Pins	No. of Outlets	Additional Information
U5052	48184	4	1	
				

Part No.	Stock No.	No. of Pins	No. of Outlets	Additional Information
U5058	48216	3	1	Triangular Connector
				

Part No.	Stock No.	No. of Pins	No. of Outlets	Additional Information
U5053	48194	2	1	
				

Part No.	Stock No.	No. of Pins	No. of Outlets	Additional Information
U5059	48221	3	1	
				

IGNITION COIL IMAGES

Part No.	Stock No.	No. of Pins	No. of Outlets	Additional Information
U5061	48226	3	1	
				

Part No.	Stock No.	No. of Pins	No. of Outlets	Additional Information
U5066	48237	2	1	
				

Part No.	Stock No.	No. of Pins	No. of Outlets	Additional Information
U5062	48227	3	1	Connector Colour: Grey
				

Part No.	Stock No.	No. of Pins	No. of Outlets	Additional Information
U5067	48239	2	1	
				

Part No.	Stock No.	No. of Pins	No. of Outlets	Additional Information
U5063	48229	3	1	
				

Part No.	Stock No.	No. of Pins	No. of Outlets	Additional Information
U5068	48240	4	1	
				

Part No.	Stock No.	No. of Pins	No. of Outlets	Additional Information
U5064	48231	3	1	
				

Part No.	Stock No.	No. of Pins	No. of Outlets	Additional Information
U5069	48241	3	1	Connector Colour: White, Incl. Spark Plug Connector
				

Part No.	Stock No.	No. of Pins	No. of Outlets	Additional Information
U5065	48235	4	1	
				

Part No.	Stock No.	No. of Pins	No. of Outlets	Additional Information
U5072	48245	2	1	
				

IGNITION COIL IMAGES

Part No.	Stock No.	No. of Pins	No. of Outlets	Additional Information
U5073	48247	2	1	
				

Part No.	Stock No.	No. of Pins	No. of Outlets	Additional Information
U5081	48266	3	1	
				

Part No.	Stock No.	No. of Pins	No. of Outlets	Additional Information
U5074	48252	3	1	
				

Part No.	Stock No.	No. of Pins	No. of Outlets	Additional Information
U5082	48267	4	1	
				

Part No.	Stock No.	No. of Pins	No. of Outlets	Additional Information
U5076	48257	4	1	
				

Part No.	Stock No.	No. of Pins	No. of Outlets	Additional Information
U5083	48268	4	1	
				

Part No.	Stock No.	No. of Pins	No. of Outlets	Additional Information
U5077	48258	4	1	
				

Part No.	Stock No.	No. of Pins	No. of Outlets	Additional Information
U5084	48269	4	1	
				

Part No.	Stock No.	No. of Pins	No. of Outlets	Additional Information
U5078	48259	2	1	
				

Part No.	Stock No.	No. of Pins	No. of Outlets	Additional Information
U5086	48273	4	1	
				

IGNITION COIL IMAGES

Part No.	Stock No.	No. of Pins	No. of Outlets	Additional Information
U5087	48274	2	1	
				

Part No.	Stock No.	No. of Pins	No. of Outlets	Additional Information
U5092	48281	3	1	
				

Part No.	Stock No.	No. of Pins	No. of Outlets	Additional Information
U5088	48275	2	1	
				

Part No.	Stock No.	No. of Pins	No. of Outlets	Additional Information
U5093	48283	3	1	
				

Part No.	Stock No.	No. of Pins	No. of Outlets	Additional Information
U5089	48276	2	1	Connector Colour: Black, Incl. Spark Plug Connector
				

Part No.	Stock No.	No. of Pins	No. of Outlets	Additional Information
U5094	48284	2	1	
				

Part No.	Stock No.	No. of Pins	No. of Outlets	Additional Information
U5090	48278	4	1	
				

Part No.	Stock No.	No. of Pins	No. of Outlets	Additional Information
U5095	48285	2	1	
				

Part No.	Stock No.	No. of Pins	No. of Outlets	Additional Information
U5091	48279	2	1	
				

Part No.	Stock No.	No. of Pins	No. of Outlets	Additional Information
U5096	48286	3	1	Connector Colour: Black
				

IGNITION COIL IMAGES

Part No.	Stock No.	No. of Pins	No. of Outlets	Additional Information
U5097	48292	3	1	



A black ignition coil with a blue terminal at the end of the shaft. The top has a black plastic housing with a small opening.

Part No.	Stock No.	No. of Pins	No. of Outlets	Additional Information
U5102	48319	4	1	



A black ignition coil with a grey plastic housing at the top. The shaft is black and ends in a single outlet.

Part No.	Stock No.	No. of Pins	No. of Outlets	Additional Information
U5098	48293	3	1	



A black ignition coil with a blue terminal at the end of the shaft. The top has a black plastic housing.

Part No.	Stock No.	No. of Pins	No. of Outlets	Additional Information
U5103	48320	2	1	



A black ignition coil with a grey plastic housing at the top. The shaft is black and ends in a single outlet.

Part No.	Stock No.	No. of Pins	No. of Outlets	Additional Information
U5099	48295	3	1	



A black ignition coil with a grey plastic housing at the top. The shaft is black and ends in a single outlet.

Part No.	Stock No.	No. of Pins	No. of Outlets	Additional Information
U5104	48321	3	1	



A black ignition coil with a grey plastic housing at the top. The shaft is black and ends in a single outlet.

Part No.	Stock No.	No. of Pins	No. of Outlets	Additional Information
U5100	48297	4	1	



A black ignition coil with a grey plastic housing at the top. The shaft is black and ends in a single outlet.

Part No.	Stock No.	No. of Pins	No. of Outlets	Additional Information
U5105	48322	3	1	



A black ignition coil with a grey plastic housing at the top. The shaft is black and ends in a single outlet.

Part No.	Stock No.	No. of Pins	No. of Outlets	Additional Information
U5101	48317	3	1	



A black ignition coil with a grey plastic housing at the top. The shaft is black and ends in a single outlet.

Part No.	Stock No.	No. of Pins	No. of Outlets	Additional Information
U5106	48323	3	1	





A black ignition coil with a grey plastic housing at the top. The shaft is black and ends in a single outlet.

IGNITION COIL IMAGES

Part No.	Stock No.	No. of Pins	No. of Outlets	Additional Information
U5110	48330	3	1	Connector Colour: Black, Incl. Spark Plug Connector
				

Part No.	Stock No.	No. of Pins	No. of Outlets	Additional Information
U5115	48335	3	1	Connector Colour: White
				

Part No.	Stock No.	No. of Pins	No. of Outlets	Additional Information
U5111	48331	3	1	Connector Colour: Black, Incl. Spark Plug Connector
				

Part No.	Stock No.	No. of Pins	No. of Outlets	Additional Information
U5117	48337	4	1	Incl. Spark Plug Connector
				

Part No.	Stock No.	No. of Pins	No. of Outlets	Additional Information
U5112	48332	3	1	Connector Colour: Black, Incl. Spark Plug Connector
				

Part No.	Stock No.	No. of Pins	No. of Outlets	Additional Information
U5118	48338	3	1	
				

Part No.	Stock No.	No. of Pins	No. of Outlets	Additional Information
U5113	48333	3	1	Connector Colour: Black, Incl. Spark Plug Connector
				

Part No.	Stock No.	No. of Pins	No. of Outlets	Additional Information
U5119	48347	3	1	
				

Part No.	Stock No.	No. of Pins	No. of Outlets	Additional Information
U5114	48334	3	1	Incl. Spark Plug Connector
				

Part No.	Stock No.	No. of Pins	No. of Outlets	Additional Information
U5121	48265	3	2	
				

IGNITION COIL IMAGES

Part No.	Stock No.	No. of Pins	No. of Outlets	Additional Information
U5123	48350	3	1	
				

Part No.	Stock No.	No. of Pins	No. of Outlets	Additional Information
U5148	48398	3	1	
				

Part No.	Stock No.	No. of Pins	No. of Outlets	Additional Information
U5130	49072	4	1	
				

Part No.	Stock No.	No. of Pins	No. of Outlets	Additional Information
U5149	48399	4	1	
				

Part No.	Stock No.	No. of Pins	No. of Outlets	Additional Information
U5134	49073	3	1	
				

Part No.	Stock No.	No. of Pins	No. of Outlets	Additional Information
U5153	48408	4	1	
				

Part No.	Stock No.	No. of Pins	No. of Outlets	Additional Information
U5145	48395	4	1	
				

Part No.	Stock No.	No. of Pins	No. of Outlets	Additional Information
U5154	48409	4	1	
				

Part No.	Stock No.	No. of Pins	No. of Outlets	Additional Information
U5147	48397	3	1	
				

Part No.	Stock No.	No. of Pins	No. of Outlets	Additional Information
U5155	48410	3	1	
				

IGNITION COIL IMAGES

Part No.	Stock No.	No. of Pins	No. of Outlets	Additional Information
U5156	48411	3	1	
				

Part No.	Stock No.	No. of Pins	No. of Outlets	Additional Information
U5309	49047	3	1	
				

Part No.	Stock No.	No. of Pins	No. of Outlets	Additional Information
U5181	48562	3	1	
				

Part No.	Stock No.	No. of Pins	No. of Outlets	Additional Information
U5310	49048	2	1	
				

Part No.	Stock No.	No. of Pins	No. of Outlets	Additional Information
U5210	49060	3	1	
				

Part No.	Stock No.	No. of Pins	No. of Outlets	Additional Information
U5314	49052	2	1	
				

Part No.	Stock No.	No. of Pins	No. of Outlets	Additional Information
U5225	49070	3	1	
				

Part No.	Stock No.	No. of Pins	No. of Outlets	Additional Information
U5315	49053	4	1	
				

Part No.	Stock No.	No. of Pins	No. of Outlets	Additional Information
U5244	49066	4	1	
				

Part No.	Stock No.	No. of Pins	No. of Outlets	Additional Information
U5316	49054	2	1	
				

IGNITION COIL IMAGES

Part No.	Stock No.	No. of Pins	No. of Outlets	Additional Information
U5317	49055	2	1	
				

Part No.	Stock No.	No. of Pins	No. of Outlets	Additional Information
U6001	48004	6	4	
				

Part No.	Stock No.	No. of Pins	No. of Outlets	Additional Information
U5319	49057	3	1	
				

Part No.	Stock No.	No. of Pins	No. of Outlets	Additional Information
U6002	48006	6	4	Incl. Spark Plug Connector
				

Part No.	Stock No.	No. of Pins	No. of Outlets	Additional Information
U5320	49058	3	1	
				

Part No.	Stock No.	No. of Pins	No. of Outlets	Additional Information
U6003	48011	5	4	Incl. Spark Plug Connector
				

Part No.	Stock No.	No. of Pins	No. of Outlets	Additional Information
U5322	49061	3	1	
				

Part No.	Stock No.	No. of Pins	No. of Outlets	Additional Information
U6004	48014	4	4	Connector Colour: Grey, Incl. Spark Plug Connector
				

Part No.	Stock No.	No. of Pins	No. of Outlets	Additional Information
U5323	49062	3	1	
				

Part No.	Stock No.	No. of Pins	No. of Outlets	Additional Information
U6005	48016	4	4	Connector Colour: White, Incl. Spark Plug Connector
				

IGNITION COIL IMAGES

Part No.	Stock No.	No. of Pins	No. of Outlets	Additional Information
U6006	48017	3	4	Incl. Spark Plug Connector
				

Part No.	Stock No.	No. of Pins	No. of Outlets	Additional Information
U6011	48045	4	4	Connector Colour: Black, Incl. Spark Plug Connector
				

Part No.	Stock No.	No. of Pins	No. of Outlets	Additional Information
U6007	48022	5	3	Incl. Spark Plug Connector
				

Part No.	Stock No.	No. of Pins	No. of Outlets	Additional Information
U6012	48051	4	4	Incl. Spark Plug Connector
				

Part No.	Stock No.	No. of Pins	No. of Outlets	Additional Information
U6008	48023	4	4	Connector Colour: Black, Incl. Spark Plug Connector
				

Part No.	Stock No.	No. of Pins	No. of Outlets	Additional Information
U6013	48071	6	4	Incl. Spark Plug Connector
				

Part No.	Stock No.	No. of Pins	No. of Outlets	Additional Information
U6009	48032	4	4	Incl. Spark Plug Connector
				

Part No.	Stock No.	No. of Pins	No. of Outlets	Additional Information
U6014	48072	6	4	Incl. Spark Plug Connector
				

Part No.	Stock No.	No. of Pins	No. of Outlets	Additional Information
U6010	48043	6	4	Incl. Spark Plug Connector
				

Part No.	Stock No.	No. of Pins	No. of Outlets	Additional Information
U6015	48074	4	4	Incl. Spark Plug Connector
				

IGNITION COIL IMAGES

Part No.	Stock No.	No. of Pins	No. of Outlets	Additional Information
U6016	48075	4	6	Incl. Spark Plug Connector
				

Part No.	Stock No.	No. of Pins	No. of Outlets	Additional Information
U6021	48124	6	4	
				

Part No.	Stock No.	No. of Pins	No. of Outlets	Additional Information
U6017	48076	4	4	Connector Colour: Grey, Incl. Spark Plug Connector
				

Part No.	Stock No.	No. of Pins	No. of Outlets	Additional Information
U6022	48126	5	3	
				

Part No.	Stock No.	No. of Pins	No. of Outlets	Additional Information
U6018	48077	6	4	Incl. Spark Plug Connector
				

Part No.	Stock No.	No. of Pins	No. of Outlets	Additional Information
U6023	48128	10	4	Housing Colour: Red
				

Part No.	Stock No.	No. of Pins	No. of Outlets	Additional Information
U6019	48083	6	4	Incl. Spark Plug Connector
				

Part No.	Stock No.	No. of Pins	No. of Outlets	Additional Information
U6025	48135	6	4	Incl. Spark Plug Connector
				

Part No.	Stock No.	No. of Pins	No. of Outlets	Additional Information
U6020	48114	4	4	Oval Connector
				

Part No.	Stock No.	No. of Pins	No. of Outlets	Additional Information
U6026	48146	9	4	Incl. Spark Plug Connector
				

IGNITION COIL IMAGES

Part No.	Stock No.	No. of Pins	No. of Outlets	Additional Information
U6027	48151	6	4	
				

Part No.	Stock No.	No. of Pins	No. of Outlets	Additional Information
U6032	48219	4	6	
				

Part No.	Stock No.	No. of Pins	No. of Outlets	Additional Information
U6028	48159	6	4	Incl. Spark Plug Connector
				

Part No.	Stock No.	No. of Pins	No. of Outlets	Additional Information
U6033	48234	4	4	Angular Connector
				

Part No.	Stock No.	No. of Pins	No. of Outlets	Additional Information
U6029	48178	5	3	Connector Colour: Black
				

Part No.	Stock No.	No. of Pins	No. of Outlets	Additional Information
U6034	48282	6	4	Without Spark Plug Connector
				

Part No.	Stock No.	No. of Pins	No. of Outlets	Additional Information
U6030	48192	5	3	Connector Colour: Grey
				

Part No.	Stock No.	No. of Pins	No. of Outlets	Additional Information
U6035	48318	3	4	
				

Part No.	Stock No.	No. of Pins	No. of Outlets	Additional Information
U6031	48205	5	3	Connector Colour: Grey
				

Part No.	Stock No.	No. of Pins	No. of Outlets	Additional Information
U6036	48007	4	4	With Ignition Cable, Three-Point Mounting
				

IGNITION COIL IMAGES

Part No.	Stock No.	No. of Pins	No. of Outlets	Additional Information
U6037	48048	3	4	Without Spark Plug Connector, Incl. Control Unit
				

Part No.	Stock No.	No. of Pins	No. of Outlets	Additional Information
U6052	49075	4	4	With Ignition Cable (U2028 Without Ignition Cable)
				

Part No.	Stock No.	No. of Pins	No. of Outlets	Additional Information
U6039	48404	7	4	
				

Part No.	Stock No.	No. of Pins	No. of Outlets	Additional Information
U6053	49076	7	4	
				

Part No.	Stock No.	No. of Pins	No. of Outlets	Additional Information
U6040	48405	4	4	
				

Part No.	Stock No.	No. of Pins	No. of Outlets	Additional Information
U6054	49077	7	4	
				

Part No.	Stock No.	No. of Pins	No. of Outlets	Additional Information
U6041	48406	7	4	
				

Part No.	Stock No.	No. of Pins	No. of Outlets	Additional Information
U6055	49086	6	4	Comes Supplied With HT Leads And Captive Mounting Bolts
				

Part No.	Stock No.	No. of Pins	No. of Outlets	Additional Information
U6042	48407	7	4	
				

CONVERSION CHART

IMPORTANT:

This chart is furnished as a guide only. Always refer to the main application data to select the recommended Ignition Coil for specific engines.

ALFA ROMEO - see FIAT GROUP		
AMC	NGK → STOCK No.	
8983501871	U1054	48217
ANGLI		
	NGK → STOCK No.	
15003	U1030	48137
15004	U1008	48064
15005	U3001	48013
15007	U2006	48025
15008	U1041	48186
15010	U1025	48121
15011	U2046	48197
15013	U3013	48175
15014	U5040	48154
15015	U2014	48052
15016	U5016	48046
15017	U4003	48103
15018	U4007	48149
15019	U4004	48104
15020	U5028	48102
15021	U5035	48136
15022	U5010	48034
15023	U5018	48061
15024	U6009	48032
15027	U3017	48233
15031	U1007	48062
15032	U1029	48132
15033	U1009	48066
15035	U2009	48030
15036	U2017	48067
15037	U2019	48078
15038	U2007	48026
15039	U6012	48051
15040	U6008	48023
15041	U6011	48045
15042	U6005	48016
15043	U5044	48163
15044	U6004	48014
15045	U5021	48073
15046	U6016	48075
15047	U6012	48051
15048	U5008	48031
15049	U6017	48076
15055	U1012	48092
15056	U1026	48123
15058	U3005	48028
15061	U3009	48068
15062	U3007	48058
15063	U3002	48019
15064	U3003	48020
15065	U5001	48002
15066	U6036	48007
15067	U2028	48108
15068	U5033	48127
15070	U3004	48024
15071	U4026	48018
15072	U3010	48085
15073	U4026	48018
15074	U3006	48050
15075	U1023	48115
15078	U1003	48039
15079	U3008	48060
15082	U5004	48008
15083	U2003	48010

ANGLI	NGK → STOCK No.	
15084	U5002	48003
15085	U2011	48038
15086	U5003	48005
15087	U6020	48114
15088	U5022	48082
15089	U5015	48042
15090	U5014	48041
15091	U2010	48037
15092	U5002	48003
15093	U1074	48311
15094	U1023	48115
15095	U5025	48089
15096	U2024	48087
15098	U5034	48131
15099	U5056	48207
15102	U1002	48029
15103	U1005	48057
15107	U2016	48056
15108	U1002	48029
15109	U2015	48053
15110	U2032	48145
15111	U6002	48006
15113	U6003	48011
15114	U6010	48043
15115	U6006	48017
15116	U6007	48022
15117	U6019	48083
15118	U2027	48106
15119	U2025	48096
15120	U6001	48004
15121	U6026	48146
15122	U2043	48193
15123	U6025	48135
15128	U2005	48021
15131	U2005	48021
15135	U1024	48117
15137	U5032	48122
15139	U2029	48110
15141	U4005	48119
15142	U2020	48079
15143	U5036	48139
15145	U5113	48333
15146	U2012	48044
15147	U5019	48063
15148	U5041	48155
15149	U5061	48226
15201	U2030	48133
15203	U5005	48009
15204	U5009	48033
15204	U5055	48206
15300	U1038	48180
15301	U1016	48098
15302	U1004	48054
15303	U1021	48112
15304	U1022	48113
15305	U1006	48059
15308	U1037	48176
15309	U1020	48111
15310	U1033	48148
15312	U1034	48152
15313	U1040	48182
15317	U4002	48100
15318	U4001	48055
15319	U2039	48170

ANGLI	NGK → STOCK No.	
15320	U1036	48158
15321	U1075	48324
15323	U1015	48097
15325	U5092	48281
15326	U2044	48195
15328	U2040	48173
15329	U4006	48134
15330	U5051	48179
15331	U5041	48155
15332	U2035	48160
15333	U2048	48209
15334	U5095	48285
15335	U2034	48153
15336	U1017	48099
15338	U5026	48091
15339	U4008	48157
15501	U1028	48129
15502	U5027	48095
15503	U1013	48093
15504	U1013	48093
15505	U5029	48107
15506	U1014	48094
15508	U1018	48105
15509	U1043	48188
15510	U5090	48278
15600	U5020	48065
15602	U5006	48015
15603	U6033	48234
15604	U5046	48165
15605	U5014	48041
15606	U2033	48150
15609	U5024	48088
15610	U2013	48049
15611	U5017	48047
15614	U2026	48101
15615	U5011	48035
15700	U6014	48072
15701	U6013	48071
15702	U6015	48074
15703	U6018	48077
15800	U5047	48168
15801	U5048	48172
15802	U5042	48161
15803	U2038	48169
15803	U6055	49086
15999	U5059	48221
15999	U5181	48562
16000	U2004	48012
16020	U2004	48012
16021	U2018	48070
16080	U1001	48000
16081	U1001	48000
16082	U1032	48143
16083	U1003	48039
16084	U1001	48000
16086	U2003	48010
AUDI - see VW GROUP		
BERU		
	NGK → STOCK No.	
0040100014	U5012	48036
0040100016	U5004	48008
0040100029	U2014	48052
0040100031	U5059	48221

BERU	NGK → STOCK No.	
0040100031	U5181	48562
0040100036	U5059	48221
0040100036	U5181	48562
0040100037	U2033	48150
0040100041	U5025	48089
0040100052	U5001	48002
0040100053	U5034	48131
0040100068	U5026	48091
0040100071	U5001	48002
0040100077	U5056	48207
0040100079	U2038	48169
0040100079	U6055	49086
0040100088	U5026	48091
0040100105	U1062	48299
0040100106	U1079	48342
0040100108	U1064	48301
0040100109	U1056	48236
0040100115	U1065	48302
0040100117	U1076	48339
0040100119	U1071	48308
0040100120	U1076	48339
0040100124	U1080	48343
0040100125	U1083	48346
0040100126	U1077	48340
0040100127	U1083	48346
0040100230	U2046	48197
0040100231	U2017	48067
0040100232	U2009	48030
0040100234	U2006	48025
0040100237	U2005	48021
0040100238	U2005	48021
0040100239	U2005	48021
0040100241	U6011	48045
0040100242	U3002	48019
0040100243	U3003	48020
0040100244	U1008	48064
0040100245	U3009	48068
0040100246	U3007	48058
0040100247	U1007	48062
0040100248	U1030	48137
0040100249	U1009	48066
0040100250	U1026	48123
0040100251	U1012	48092
0040100252	U1002	48029
0040100253	U1005	48057
0040100254	U3009	48068
0040100255	U3007	48058
0040100256	U6012	48051
0040100257	U1029	48132
0040100259	U6002	48006
0040100261	U1034	48152
0040100262	U4006	48134
0040100263	U1022	48113
0040100264	U2040	48173
0040100265	U2042	48189
0040100266	U2039	48170
0040100267	U2035	48160
0040100268	U2036	48166
0040100274	U1021	48112
0040100275	U1004	48054
0040100276	U1016	48098
0040100277	U1024	48117
0040100278	U1017	48099
0040100279	U1036	48158

BERU	NGK → STOCK No.		BERU	NGK → STOCK No.		BERU	NGK → STOCK No.		BERU	NGK → STOCK No.	
0040100281	U2005	48021	0040102019	U5033	48127	ZS115	U1065	48302	ZS325	U2028	48108
0040100282	U1084	48357	0040102020	U5035	48136	ZS117	U1076	48339	ZS327	U3008	48060
0040100283	U3001	48013	0040102021	U5032	48122	ZS119	U1071	48308	ZS337	U5041	48155
0040100296	U1023	48115	0040102025	U2018	48070	ZS120	U1076	48339	ZS338	U6019	48083
0040100297	U3004	48024	0040102026	U2004	48012	ZS124	U1080	48343	ZS340	U4026	48018
0040100298	U1023	48115	0040102027	U2044	48195	ZS125	U1083	48346	ZS341	U2009	48030
0040100299	U1074	48311	0040102028	U2041	48185	ZS126	U1077	48340	ZS342	U6003	48011
0040100300	U2015	48053	0040102029	U2011	48038	ZS127	U1083	48346	ZS343	U6016	48075
0040100301	U2043	48193	0040102030	U5002	48003	ZS230	U2046	48197	ZS344	U2016	48056
0040100302	U5005	48009	0040102031	U5017	48047	ZS231	U2017	48067	ZS345	U2019	48078
0040100304	U3010	48085	0040102032	U5014	48041	ZS232	U2009	48030	ZS346	U5021	48073
0040100306	U2027	48106	0040102033	U5015	48042	ZS234	U2006	48025	ZS347	U5008	48031
0040100307	U2030	48133	0040102034	U5003	48005	ZS237	U2005	48021	ZS348	U6009	48032
0040100308	U4005	48119	0040102037	U1035	48156	ZS238	U2005	48021	ZS349	U6012	48051
0040100309	U4007	48149	0040102038	U1033	48148	ZS239	U2005	48021	ZS350	U2001	48001
0040100310	U5047	48168	0040102039	U6033	48234	ZS241	U6011	48045	ZS351	U6014	48072
0040100311	U5016	48046	0040102040	U6020	48114	ZS242	U3002	48019	ZS352	U6013	48071
0040100315	U3008	48060	0040102043	U5003	48005	ZS243	U3003	48020	ZS353	U6018	48077
0040100316	U1012	48092	0040102044	U5020	48065	ZS244	U1008	48064	ZS354	U2007	48026
0040100317	U3005	48028	0040102045	U6004	48014	ZS245	U3009	48068	ZS355	U3015	48218
0040100320	U5010	48034	0040102046	U6017	48076	ZS246	U3007	48058	ZS356	U1013	48093
0040100321	U5048	48172	0040102047	U6005	48016	ZS247	U1007	48062	ZS358	U6007	48022
0040100322	U5018	48061	0040102048	U6015	48074	ZS248	U1030	48137	ZS359	U6022	48126
0040100323	U5044	48163	0040102051	U5013	48040	ZS249	U1009	48066	ZS361	U4004	48104
0040100324	U5009	48033	0040102055	U5037	48140	ZS250	U1026	48123	ZS365	U2001	48001
0040100324	U5055	48206	0040102056	U5043	48162	ZS251	U1012	48092	ZS367	U5031	48120
0040100325	U2028	48108	0040102059	U5006	48015	ZS252	U1002	48029	ZS368	U5038	48144
0040100327	U3008	48060	0040102061	U5024	48088	ZS253	U1005	48057	ZS371	U2020	48079
0040100337	U5041	48155	0040102063	U5011	48035	ZS254	U3009	48068	ZS372	U2023	48086
0040100338	U6019	48083	0040102065	U5046	48165	ZS255	U3007	48058	ZS379	U2044	48195
0040100340	U4026	48018	0040102066	U5094	48284	ZS256	U6012	48051	ZS380	U2041	48185
0040100341	U2009	48030	0040102072	U5092	48281	ZS257	U1029	48132	ZS381	U6008	48023
0040100342	U6003	48011	0040102075	U5111	48331	ZS259	U6002	48006	ZS387	U2008	48027
0040100343	U6016	48075	0040102077	U5110	48330	ZS261	U1034	48152	ZS394	U1086	48204
0040100344	U2016	48056	0040102078	U5111	48331	ZS262	U4006	48134	ZS396	U1085	48203
0040100345	U2019	48078	0040102079	U5112	48332	ZS263	U1022	48113	ZS405	U2049	48220
0040100346	U5021	48073	0040102080	U5061	48226	ZS264	U2040	48173	ZS410	U5089	48276
0040100347	U5008	48031	0040102081	U5036	48139	ZS265	U2042	48189	ZS419	U1075	48324
0040100348	U6009	48032	0040102082	U5113	48333	ZS266	U2039	48170	ZS427	U6001	48004
0040100349	U6012	48051	0040102083	U4011	48208	ZS267	U2035	48160	ZS428	U5040	48154
0040100350	U2001	48001	0040102084	U4013	48223	ZS268	U2036	48166	ZS429	U4009	48171
0040100351	U6014	48072	0040102086	U4023	48314	ZS274	U1021	48112	ZS430	U4024	48326
0040100352	U6013	48071	0040102087	U4022	48313	ZS275	U1004	48054	ZS432	U5078	48259
0040100353	U6018	48077	0040102502	U4006	48134	ZS276	U1016	48098	ZS434	U4020	48291
0040100354	U2007	48026	0040103007	U3006	48050	ZS277	U1024	48117	ZS501	U4001	48055
0040100355	U3015	48218	0040402001	U1001	48000	ZS278	U1017	48099	ZS502	U4002	48100
0040100356	U1013	48093	0040402002	U1003	48039	ZS279	U1036	48158	ZS508	U6035	48318
0040100358	U6007	48022	0040402003	U2003	48010	ZS281	U2005	48021	ZS523	U1020	48111
0040100359	U6022	48126	0040402004	U2024	48087	ZS282	U1084	48357	ZSE001	U1001	48000
0040100361	U4004	48104	0040402008	U2013	48049	ZS283	U3001	48013	ZSE002	U1003	48039
0040100365	U2001	48001	0040402009	U5022	48082	ZS296	U1023	48115	ZSE003	U2003	48010
0040100367	U5031	48120	0040102132	U5123	48350	ZS297	U3004	48024	ZSE004	U2024	48087
0040100368	U5038	48144	0040402011	U1037	48176	ZS298	U1023	48115	ZSE008	U2013	48049
0040100371	U2020	48079	0040402502	U4006	48134	ZS299	U1074	48311	ZSE009	U5022	48082
0040100372	U2023	48086	ZS014	U5012	48036	ZS300	U2015	48053	ZSE011	U1037	48176
0040100379	U2044	48195	ZS016	U5004	48008	ZS301	U2043	48193	ZSE013	U2026	48101
0040100380	U2041	48185	ZS029	U2014	48052	ZS302	U5005	48009	ZSE019	U5033	48127
0040100381	U6008	48023	ZS031	U5059	48221	ZS304	U3010	48085	ZSE020	U5035	48136
0040100387	U2008	48027	ZS031	U5181	48562	ZS306	U2027	48106	ZSE021	U5032	48122
0040100394	U1086	48204	ZS036	U5059	48221	ZS307	U2030	48133	ZSE025	U2018	48070
0040100396	U1085	48203	ZS036	U5181	48562	ZS308	U4005	48119	ZSE026	U2004	48012
0040100405	U2049	48220	ZS037	U2033	48150	ZS309	U4007	48149	ZSE027	U2044	48195
0040100410	U5089	48276	ZS041	U5025	48089	ZS310	U5047	48168	ZSE028	U2041	48185
0040100419	U1075	48324	ZS052	U5001	48002	ZS311	U5016	48046	ZSE029	U2011	48038
0040100427	U6001	48004	ZS053	U5034	48131	ZS313	U3006	48050	ZSE030	U5002	48003
0040100428	U5040	48154	ZS068	U5026	48091	ZS315	U3008	48060	ZSE031	U5017	48047
0040100429	U4009	48171	ZS077	U5056	48207	ZS316	U1012	48092	ZSE032	U5014	48041
0040100430	U4024	48326	ZS079	U2038	48169	ZS317	U3005	48028	ZSE033	U5015	48042
0040100432	U5078	48259	ZS079	U6055	49086	ZS320	U5010	48034	ZSE034	U5003	48005
0040100501	U4001	48055	ZS088	U5026	48091	ZS321	U5048	48172	ZSE037	U1035	48156
0040100502	U4002	48100	ZS105	U1062	48299	ZS322	U5018	48061	ZSE038	U1033	48148
0040100508	U6035	48318	ZS106	U1079	48342	ZS323	U5044	48163	ZSE039	U6033	48234
0040100523	U1020	48111	ZS108	U1064	48301	ZS324	U5009	48033	ZSE040	U6020	48114
0040102013	U2026	48101	ZS109	U1056	48236	ZS324	U5055	48206	ZSE043	U5003	48005

BERU	NGK → STOCK No.	
ZSE044	U5020	48065
ZSE045	U6004	48014
ZSE046	U6017	48076
ZSE047	U6005	48016
ZSE048	U6015	48074
ZSE051	U5013	48040
ZSE055	U5037	48140
ZSE056	U5043	48162
ZSE059	U5006	48015
ZSE061	U5024	48088
ZSE063	U5011	48035
ZSE065	U5046	48165
ZSE066	U5094	48284
ZSE069	U4008	48157
ZSE072	U5092	48281
ZSE075	U5111	48331
ZSE077	U5110	48330
ZSE078	U5111	48331
ZSE079	U5112	48332
ZSE080	U5061	48226
ZSE081	U5036	48139
ZSE082	U5113	48333
ZSE083	U4011	48208
ZSE084	U4013	48223
ZSE086	U4023	48314
ZSE087	U4022	48313
ZSE088	U5119	48347
ZSE132	U5123	48350
ZSE502	U4006	48134

BENTLEY - see VW GROUP

BMW	NGK → STOCK No.	
12131247281	U2030	48133
12131273216	U1082	48345
12131317232	U5012	48036
12131317585	U5012	48036
12131357294	U1065	48302
12131357295	U1065	48302
12131357296	U1079	48342
12131359637	U1079	48342
12131402440	U5012	48036
12131402713	U5012	48036
12131404102	U5012	48036
12131404309	U5005	48009
12131487707	U2073	48368
12131703227	U5005	48009
12131703228	U5005	48009
12131703359	U5012	48036
12131703825	U5005	48009
12131712219	U5009	48033
12131712219	U5055	48206
12131712223	U5009	48033
12131712223	U5055	48206
12131720166	U5012	48036
12131726176	U5012	48036
12131726177	U5012	48036
12131726178	U5012	48036
12131727108	U5012	48036
12131729842	U5012	48036
12131730502	U5012	48036
12131730765	U5012	48036
12131730766	U5012	48036
12131731134	U5012	48036
12131731884	U5012	48036
12131734468	U5012	48036
12131748017	U5005	48009
12131748018	U5005	48009
12131748394	U5012	48036
12131748395	U5012	48036
12131777666	U5012	48036
12137510738	U2073	48368
12137523345	U5058	48216
12137548553	U5058	48216

BMW	NGK → STOCK No.	
12137551049	U5055	48206
12137551260	U5009	48033
12137551260	U5055	48206
12137562744	U5055	48206
12137562745	U5039	48147
12137571643	U5055	48206
12137571644	U5039	48147
12137582627	U5039	48147
12137594935	U5039	48147
12137594936	U5058	48216
12137594937	U5055	48206
12137594938	U5009	48033
12137594938	U5055	48206
12137599218	U5012	48036
12137619385	U5322	49061
12137703359	U5012	48036
12137838388	U5118	48338
12137841754	U5118	48338
12138616153	U5055	48206
12139066468	U5012	48036
12139067830	U5005	48009
1404309	U5005	48009
1703227	U5005	48009
1703825	U5005	48009
1712219	U5009	48033
1712219	U5055	48206
1712223	U5009	48033
1712223	U5055	48206
1726176	U5012	48036
1726177	U5012	48036
1726178B	U5012	48036
1726178	U5012	48036
1730765	U5012	48036
1731134B	U5012	48036
1731178B	U5012	48036
1748017	U5005	48009
1748018	U5005	48009
1748394	U5012	48036
1777666	U5012	48036
7551260	U5009	48033
7551260	U5055	48206
7599219	U5005	48009
7619385	U5322	49061
784175401	U5118	48338

BOSCH	NGK → STOCK No.	
0 221 102 020	U1065	48302
0 221 102 020	U1065	48302
0 221 102 031	U1065	48302
0 221 102 035	U1065	48302
0 221 102 042	U1065	48302
0 221 102 047	U1065	48302
0 221 102 060	U1065	48302
0 221 102 084	U1065	48302
0 221 118 307	U1076	48339
0 221 118 329	U1023	48115
0 221 118 351	U1071	48308
0 221 119 021	U1065	48302
0 221 119 022	U1056	48236
0 221 119 023	U1064	48301
0 221 119 025	U1079	48342
0 221 119 027	U1079	48342
0 221 119 030	U1056	48236
0 221 119 037	U1065	48302
0 221 119 046	U1063	48300
0 221 119 051	U1065	48302
0 221 119 355	U1066	48303
0 221 119 373	U1065	48302
0 221 122 001	U1076	48339
0 221 122 006	U1068	48305
0 221 122 017	U1070	48307
0 221 122 023	U1078	48341
0 221 122 319	U1082	48345
0 221 122 334	U1076	48339

BOSCH	NGK → STOCK No.	
0 221 122 349	U1080	48343
0 221 122 350	U1081	48344
0 221 122 367	U1077	48340
0 221 122 369	U1069	48306
0 221 122 379	U1081	48344
0 221 122 380	U1081	48344
0 221 122 400	U1081	48344
0 221 122 402	U1083	48346
0 221 122 450	U1077	48340
0 221 124 001	U1062	48299
0 221 501 374	U1023	48115
0 221 501 376	U1074	48311
0 221 502 429	U1023	48115
0 221 502 433	U1023	48115
0 221 502 435	U1074	48311
0 221 503 001	U2015	48053
0 221 503 002	U2043	48193
0 221 503 003	U2017	48067
0 221 503 004	U2009	48030
0 221 503 005	U2030	48133
0 221 503 006	U2017	48067
0 221 503 010	U2025	48096
0 221 503 011	U2032	48145
0 221 503 012	U3004	48024
0 221 503 014	U6007	48022
0 221 503 015	U6010	48043
0 221 503 016	U2068	48325
0 221 503 017	U2027	48106
0 221 503 018	U6006	48017
0 221 503 021	U2068	48325
0 221 503 022	U3010	48085
0 221 503 024	U2017	48067
0 221 503 025	U2009	48030
0 221 503 026	U6029	48178
0 221 503 027	U6030	48192
0 221 503 031	U6028	48159
0 221 503 033	U6006	48017
0 221 503 035	U3004	48024
0 221 503 407	U2006	48025
0 221 503 417	U2046	48197
0 221 503 468	U6025	48135
0 221 503 469	U6027	48151
0 221 503 471	U6022	48126
0 221 503 472	U6019	48083
0 221 503 473	U6031	48205
0 221 503 485	U2008	48027
0 221 503 487	U2012	48044
0 221 503 489	U2030	48133
0 221 503 490	U2001	48001
0 221 504 001	U5114	48334
0 221 504 004	U5005	48009
0 221 504 005	U5047	48168
0 221 504 006	U5047	48168
0 221 504 014	U5016	48046
0 221 504 016	U5030	48116
0 221 504 017	U5041	48155
0 221 504 020	U5030	48116
0 221 504 024	U5096	48286
0 221 504 029	U5005	48009
0 221 504 030	U5069	48241
0 221 504 035	U5156	48411
0 221 504 100	U5009	48033
0 221 504 100	U5055	48206
0 221 504 410	U5012	48036
0 221 504 456	U5040	48154
0 221 504 460	U5048	48172
0 221 504 463	U5058	48216
0 221 504 464	U5009	48033
0 221 504 464	U5055	48206
0 221 504 465	U5058	48216
0 221 504 467	U5055	48206
0 221 504 470	U5055	48206
0 221 504 471	U5039	48147
0 221 504 474	U5012	48036

BOSCH	NGK → STOCK No.	
0 221 505 423	U4005	48119
0 221 505 437	U3006	48050
0 221 506 002	U4026	48018
0 221 506 444	U4026	48018
0 221 601 001	U1003	48039
0 221 601 012	U1035	48156
0 221 603 003	U6037	48048
0 221 603 006	U2003	48010
0 221 604 001	U5033	48127
0 221 604 006	U5050	48177
0 221 604 008	U5033	48127
0 221 604 010	U5037	48140
0 221 604 014	U5043	48162
0 221 604 103	U5042	48161
0 221 604 104	U5049	48174
0 221 604 109	U5015	48042
0 221 604 112	U5049	48174
0 221 604 113	U5015	48042
0 221 604 115	U5014	48041
0 986 221 000	U1001	48000
0 986 221 001	U5001	48002
0 986 221 002	U1003	48039
0 986 221 003	U2014	48052
0 986 221 004	U2040	48173
0 986 221 005	U2039	48170
0 986 221 006	U1037	48176
0 986 221 007	U5025	48089
0 986 221 008	U2035	48160
0 986 221 010	U1022	48113
0 986 221 011	U5004	48008
0 986 221 012	U1034	48152
0 986 221 013	U2042	48189
0 986 221 015	U2024	48087
0 986 221 016	U5059	48221
0 986 221 016	U5181	48562
0 986 221 017	U2033	48150
0 986 221 018	U4006	48134
0 986 221 019	U2036	48166
0 986 221 021	U2052	48249
0 986 221 023	U5002	48003
0 986 221 024	U5003	48005
0 986 221 025	U3002	48019
0 986 221 026	U3003	48020
0 986 221 027	U1008	48064
0 986 221 029	U1009	48066
0 986 221 030	U3009	48068
0 986 221 031	U3007	48058
0 986 221 033	U3008	48060
0 986 221 034	U6008	48023
0 986 221 035	U6005	48016
0 986 221 036	U6036	48007
0 986 221 037	U1025	48121
0 986 221 038	U3013	48175
0 986 221 039	U6002	48006
0 986 221 040	U5034	48131
0 986 221 042	U5010	48034
0 986 221 043	U5018	48061
0 986 221 044	U4001	48055
0 986 221 046	U2028	48108
0 986 221 047	U5006	48015
0 986 221 048	U2003	48010
0 986 221 049	U2011	48038
0 986 221 050	U5017	48047
0 986 221 051	U5020	48065
0 986 221 052	U5014	48041
0 986 221 053	U5013	48040
0 986 221 054	U5024	48088
0 986 221 055	U5046	48165
0 986 221 056	U5020	48065
0 986 221 057	U5153	48408
0 986 221 05		

BOSCH	NGK → STOCK No.	BOUGICORD	NGK → STOCK No.	BOUGICORD	NGK → STOCK No.	BOUGICORD	NGK → STOCK No.	BREMI	NGK → STOCK No.		
0 986 221 062	U5072	48245	155034	U2017	48067	155115	U2034	48153	11883	U2006	48025
0 986 221 063	U5067	48239	155036	U6006	48017	155116	U2046	48197	11885	U1036	48158
0 986 221 075	U5316	49054	155037	U5041	48155	155125	U5054	48201	11886	U1016	48098
0 986 221 076	U5310	49048	155038	U6003	48011	155127	U6037	48048	11887	U1022	48113
0 986 221 078	U5317	49055	155039	U6001	48004	155128	U3017	48233	11889	U1021	48112
0 986 221 097	U6053	49076	155040	U6013	48071	155132	U4009	48171	11890	U1084	48357
0 986 JG1 211	U5032	48122	155041	U6018	48077	155133	U5066	48237	11891	U1002	48029
0 986 JG1 212	U5036	48139	155042	U6016	48075	155134	U5042	48161	11892	U1003	48039
0 986 JG1 213	U5061	48226	155043	U6017	48076	155135	U5030	48116	11893	U1001	48000
0 986 JG1 221	U5111	48331	155044	U4005	48119	155136	U5055	48206	11897	U1030	48137
0 986 JG1 222	U5113	48333	155045	U6022	48126	155138	U5043	48162	11898	U1008	48064
0 986 JG1 224	U5098	48293	155046	U6025	48135	155139	U5025	48089	11899	U3001	48013
0 986 JG1 225	U5097	48292	155047	U1022	48113	155140	U5029	48107	11900	U1025	48121
1 227 020 023	U1069	48306	155048	U2018	48070	155141	U5052	48184	11910	U1083	48346
1 227 020 036	U1082	48345	155049	U5009	48033	155142	U5090	48278	11912	U1069	48306
1 227 030 059	U4003	48103	155049	U5055	48206	155143	U5094	48284	11914	U1038	48180
1 227 030 062	U4007	48149	155050	U2019	48078	155144	U5118	48338	11915	U1004	48054
1 227 030 071	U4004	48104	155051	U2014	48052	155146	U5096	48286	11917	U1026	48123
1 227 030 081	U5005	48009	155052	U2004	48012	155147	U5091	48279	11921	U1039	48181
1 227 030 082	U5012	48036	155053	U2031	48142	155148	U6021	48124	11922	U2016	48056
9 220 081 505	U1026	48123	155054	U5020	48065	155170	U5092	48281	11927	U1059	48253
F 000 ZS0 001	U1083	48346	155055	U6012	48051	155182	U5073	48247	11929	U2014	48052
F 000 ZS0 103	U3001	48013	155056	U1008	48064	155200	U5005	48009	11930	U3009	48068
F 000 ZS0 111	U1005	48057	155057	U2016	48056	155500	U5004	48008	11931	U3007	48058
F 000 ZS0 112	U1002	48029	155058	U1025	48121	155600	U5004	48008	11935	U1006	48059
F 000 ZS0 113	U1029	48132	155059	U1009	48066	155700	U5012	48036	11937	U2005	48021
F 000 ZS0 114	U1007	48062	155060	U1026	48123	155800	U5005	48009	20110	U5009	48033
F 000 ZS0 115	U1012	48092	155061	U1012	48092	155900	U2010	48037	20110	U5055	48206
F 000 ZS0 116	U1004	48054	155062	U1002	48029	156100	U2003	48010	20111	U5001	48002
F 000 ZS0 117	U1013	48093	155064	U1005	48057	156200	U5001	48002	20112	U5017	48047
F 000 ZS0 121	U1014	48094	155066	U1004	48054	156300	U6002	48006	20113	U5003	48005
F 000 ZS0 210	U2003	48010	155067	U1006	48059	156500	U6012	48051	20116	U5006	48015
F 000 ZS0 212	U2005	48021	155068	U1037	48176	156600	U5044	48163	20117	U5002	48003
F 000 ZS0 221	U2007	48026	155069	U1003	48039	156800	U6011	48045	20120	U5015	48042
			155070	U3010	48085	157000	U5028	48102	20121	U5011	48035
BOUGICORD	NGK → STOCK No.		155071	U1013	48093	157100	U5035	48136	20122	U5020	48065
151401	U6036	48007	155072	U3004	48024	157200	U6020	48114	20125	U5013	48040
151402	U6036	48007	155073	U1035	48156	157300	U5010	48034	20126	U5024	48088
151408	U2028	48108	155074	U2038	48169	157400	U5002	48003	20129	U2011	48038
154301	U6008	48023	155074	U6055	49086	157500	U5003	48005	20132	U2024	48087
154302	U6005	48016	155075	U2008	48027	157600	U5022	48082	20133	U2026	48101
154303	U6015	48074	155076	U2006	48025	157700	U5014	48041	20135	U4006	48134
155001	U5047	48168	155077	U3006	48050	157800	U5017	48047	20136	U6002	48006
155002	U4003	48103	155078	U2021	48080	157900	U5015	48042	20137	U1034	48152
155003	U6007	48022	155079	U1028	48129				20138	U2018	48070
155004	U4026	48018	155080	U1031	48141	BREMI	NGK → STOCK No.		20139	U2020	48079
155005	U5016	48046	155081	U3013	48175	11714	U1032	48143	20140	U1020	48111
155006	U4004	48104	155082	U1007	48062	11719	U2019	48078	20142	U3008	48060
155007	U5026	48091	155083	U1029	48132	11720	U2007	48026	20143	U2039	48170
155008	U2001	48001	155085	U1023	48115	11722	U3002	48019	20145	U5025	48089
155009	U5019	48063	155086	U1016	48098	11723	U3003	48020	20150	U5095	48285
155010	U2001	48001	155087	U5032	48122	11726	U1015	48097	20151	U5092	48281
155011	U2005	48021	155088	U5033	48127	11727	U2046	48197	20153	U3006	48050
155012	U2011	48038	155089	U2015	48053	11731	U2003	48010	20154	U1047	48200
155013	U3002	48019	155091	U2040	48173	11732	U2030	48133	20155	U2001	48001
155014	U3003	48020	155092	U5036	48139	11800	U1077	48340	20156	U6008	48023
155015	U3008	48060	155093	U2048	48209	11801	U1079	48342	20157	U3010	48085
155016	U2007	48026	155094	U2035	48160	11802	U1056	48236	20158	U1017	48099
155017	U3001	48013	155095	U5040	48154	11806	U1078	48341	20159	U2013	48049
155018	U3009	48068	155096	U1024	48117	11819	U1082	48345	20160	U2004	48012
155019	U3007	48058	155097	U2024	48087	11821	U1065	48302	20161	U6005	48016
155020	U5018	48061	155098	U2030	48133	11822	U1080	48343	20163	U1013	48093
155021	U5008	48031	155099	U4006	48134	11824	U1081	48344	20164	U2048	48209
155022	U6010	48043	155100	U5012	48036	11855T	U5012	48036	20166	U2031	48142
155024	U6023	48128	155101	U5017	48047	11860T	U5005	48009	20167	U6036	48007
155025	U3005	48028	155104	U5006	48015	11869	U5004	48008	20168	U1035	48156
155026	U1001	48000	155105	U6033	48234	11873	U3004	48024	20169	U2015	48053
155027	U6009	48032	155106	U5011	48035	11876	U1005	48057	20170	U2040	48173
155028	U5027	48095	155107	U6026	48146	11877	U1012	48092	20172	U4001	48055
155029	U6019	48083	155109	U5046	48165	11878	U1007	48062	20173	U1037	48176
155030	U5021	48073	155110	U5013	48040	11879	U1029	48132	20174	U4007	48149
155031	U6014	48072	155111	U5024	48088	11880	U1009	48066	20175	U4004	48104
155032	U6004	48014	155112	U2026	48101	11881	U2017	48067	20176	U2008	48027
155033	U2009	48030	155114	U1033	48148	11882	U2009	48030	20177	U1077	48340

BREMI	NGK → STOCK No.		BREMI	NGK → STOCK No.		CITROEN	NGK → STOCK No.		CITROEN	NGK → STOCK No.	
20178	U1083	48346	20428	U4014	48225	597004	U1079	48342	9628158580	U6008	48023
20179	U2027	48106	20432	U5087	48274	597009	U1079	48342	96292106	U6012	48051
20180	U5034	48131	20433	U5031	48120	597011	U1079	48342	9634131480	U6009	48032
20181	U2043	48193	20434	U5089	48276	597028	U1079	48342	96358649	U6005	48016
20182	U6011	48045	20435	U1045	48217	597029	U1076	48339	96362683	U5008	48031
20183	U6004	48014	20436	U1075	48324	597030	U1076	48339	96363378	U6004	48014
20184	U6010	48043	20438	U5055	48206	597034	U1076	48339	9644190980	U6034	48282
20185	U5056	48207	20441	U5054	48201	597035	U1076	48339	9651710680	U6021	48124
20186	U5033	48127	20442	U5123	48350	597042	U1029	48132	9654347080	U6015	48074
20187	U5035	48136	20443	U5145	48395	597043	U1007	48062	9654814480	U6015	48074
20188	U1023	48115	20459	U4013	48223	597045	U1009	48066	9662268	U2017	48067
20189	U6019	48083				597048	U2009	48030	9663278480	U5008	48031
20190	U4005	48119				597049	U2017	48067	9664401880	U5008	48031
20191	U5027	48095	CADIC	NGK → STOCK No.		597050	U5044	48163	97505967	U1076	48339
20193	U6003	48011	KD-8065A	U6053	49076	597051	U6040	48405	97530780	U1007	48062
20194	U4002	48100	KD-8065C	U6053	49076	597053	U2006	48025	97531206	U1029	48132
20195	U6006	48017	KD-9131	U5130	49072	597055	U5021	48073	V7562744	U5055	48206
20197	U5016	48046				597056	U6011	48045	V757164380	U5055	48206
20199	U1074	48311	CHEVROLET - see GM			597057	U6016	48075			
20200	U3005	48028	CHRYSLER GROUP	NGK → STOCK No.		597060	U2009	48030	DAIHATSU	NGK → STOCK No.	
20301	U1018	48105	25182496	U2031	48142	597064	U5055	48206	19070B1020	U5077	48258
20303	U2012	48044	4443971	U2049	48220	597070	U2009	48030	9004852003000	U1079	48342
20304	U2035	48160	4609103AB	U2041	48185	597072	U6008	48023	9004852010000	U1079	48342
20305	U2047	48202	4606824AB	U5104	48321	597073	U6012	48051	9004852072000	U1039	48181
20306	U5008	48031	4606869AA	U5105	48322	597074	U6008	48023	9004852083000	U1050	48211
20307	U4026	48018	4606869AB	U5105	48322	597075	U6009	48032	9004852094000	U1050	48211
20308	U1050	48211	4606869AC	U5105	48322	597077	U5008	48031	9004852095000	U1039	48181
20309	U1040	48182	4609088AC	U5078	48259	597078	U6005	48016			
20310	U2025	48096	4609088AD	U5078	48259	597079	U6005	48016	DAEWOO - see GM		
20311	U2032	48145	4609088AF	U5078	48259	597080	U6004	48014			
20312	U5040	48154	4609088AG	U5078	48259	597081	U6017	48076	DELPHI	NGK → STOCK No.	
20313	U5019	48063	4609140AB	U2058	48261	597084	U6014	48072	CE10000-12B1	U6002	48006
20314	U5030	48116	4797293	U1086	48204	597085	U6021	48124	CE10001-12B1	U2021	48080
20315	U4021	48294	5233140	U2049	48220	597087	U6013	48071	CE10020-12B1	U3005	48028
20316	U5021	48073	5234210	U1086	48204	597088	U5029	48107	CE10021-12B1	U3009	48068
20318	U5043	48162	5234610	U1086	48204	597090	U6015	48074	CE10023-12B1	U1001	48000
20319	U1023	48115	5252577	U1086	48204	597091	U5055	48206	CE10027-12B1	U5026	48091
20320	U6009	48032	5269670	U2041	48185	597092	U6018	48077	CE10510-12B1	U1002	48029
20321	U6022	48126	53008068	U1086	48204	597094	U5008	48031	CE10512-12B1	U4001	48055
20322	U5036	48139	56027965	U1086	48204	597095	U6034	48282	CE10513-12B1	U2036	48166
20323	U5029	48107	56028138	U5053	48194	597097	U6015	48074	CE10514-12B1	U1027	48125
20324	U5111	48331	56028138AB	U5053	48194	597098	U6009	48032	CE20009-12B1	U6001	48004
20325	U5113	48333	56028138AD	U5053	48194	597099	U6004	48014	CE20010-12B1	U6008	48023
20327	U5114	48334	56028138AE	U5053	48194	5970A0	U6013	48071	CE20011-12B1	U6005	48016
20328	U5041	48155	56028138AF	U5053	48194	5970A1	U6016	48075	CE20014-12B1	U5001	48002
20329	U2029	48110	56028172	U1085	48203	5970A2	U6011	48045	CE20017-12B1	U6036	48007
20332	U1014	48094	56028172AB	U1085	48203	5970A3	U6017	48076	CE20018-12B1	U2028	48108
20334	U6013	48071	56028394AB	U4017	48264	5970A4	U6012	48051	CE20019-12B1	U5004	48008
20335	U6007	48022	56028394AC	U4017	48264	5970A5	U6014	48072	CE20024-12B1	U6012	48051
20336	U5047	48168	56028394AD	U4017	48264	5970A6	U6018	48077	CE20026-12B1	U6011	48045
20337	U5061	48226	56029129AA	U5121	48265	5970A7	U6040	48405	CE20029-12B1	U6033	48234
20338	U4003	48103	56029129AB	U5121	48265	5970A8	U6005	48016	CE20030-12B1	U5002	48003
20339	U2060	48287	56029129AF	U5121	48265	5970A9	U6008	48023	CE20034-12B1	U5015	48042
20344	U2051	48230	56032520AB	U2057	48260	5970C1	U5029	48107	CE20035-12B1	U5047	48168
20346	U5086	48273	56032520AC	U2057	48260	91503380	U1076	48339	CE20036-12B1	U4003	48103
20350	U2062	48289	56032520AE	U2057	48260	91506337	U1076	48339	CE20038-12B1	U4026	48018
20351	U2044	48195	56041019	U6032	48219	9150338080	U1076	48339	CE20039-12B1	U5016	48046
20352	U6016	48075	83502140	U1054	48217	9467511580	U6015	48074	CE20040-12B1	U4004	48104
20356	U1086	48204	K04606824AC	U5104	48321	95539008	U3017	48233	CE20042-12B1	U2001	48001
20357	U4023	48314	K04609088AH	U5078	48259	96010513	U1007	48062	CE20043-12B1	U5019	48063
20358	U1085	48203	MO4777667	U2041	48185	96035284	U1009	48066	CE20044-12B1	U2001	48001
20359	U4022	48313	T1031135	U1012	48092	96062288	U2017	48067	CE20046-12B1	U3002	48019
20361	U4019	48270				96074054	U2009	48030	CE20047-12B1	U3003	48020
20362	U3018	48280	CITROEN	NGK → STOCK No.		9611412080	U5044	48163	CE20048-12B1	U2007	48026
20364	U4009	48171	2526086	U6016	48075	96165970	U2009	48030	CE20053-12B1	U1026	48123
20365	U6030	48192	5059822	U1079	48342	96211048	U6040	48405	CE20054-12B1	U5044	48163
20368	U6029	48178	5060159	U1079	48342	9621104880	U6040	48405	CE20055-12B1	U3008	48060
20369	U4020	48291	5490504	U1076	48339	96213086	U6011	48045	CE20056-12B1	U5018	48061
20378	U5072	48245	5491302	U1076	48339	9621308680	U6011	48045	CE20057-12B1	U5048	48172
20379	U4015	48242	5491559	U1076	48339	96213181	U5021	48073	CE20058-12B1	U3001	48013
20388	U5073	48247	55505600	U1079	48342	96228897	U2009	48030	CE20060-12B1	U1009	48066
20398	U5076	48257	594029	U1026	48123	96246755	U6008	48023	CE20061-12B1	U2014	48052
20399	U5062	48227	596318	U6040	48405	9624675580	U6008	48023	CE20062-12B1	U5010	48034
20427	U5049	48174	596319	U6008	48023	96281585	U6008	48023	DS10000-12B1	U2004	48012

DELPHI	NGK → STOCK No.	DELPHI	NGK → STOCK No.	ERA	NGK → STOCK No.	ERA	NGK → STOCK No.				
DS20013-12B1	U2018	48070	GN10366-12B1	U5084	48269	880021	U3003	48020	880111	U1079	48342
DS20026-11B1	U6026	48146	GN10370-12B1	U5064	48231	880022	U1076	48339	880113	U1031	48141
GN10016-11B1	U5005	48009	GN10375-12B1	U6025	48135	880023	U1007	48062	880114	U2034	48153
GN10018-11B1	U2003	48010	GN10378-12B1	U1003	48039	880024	U1029	48132	880115	U3009	48068
GN10024-11B1	U1024	48117	GN10382-12B1	U5097	48292	880025	U1030	48137	880116	U3007	48058
GN10028-11B1	U1021	48112	GN10383-12B1	U2011	48038	880026	U1009	48066	880117	U6015	48074
GN10068-11B1	U1004	48054	GN10396-12B1	U3016	48228	880027	U1026	48123	880118	U6013	48071
GN10123-11B1	U3015	48218	GN10401-12B1	U6039	48404	880028	U1012	48092	880119	U6018	48077
GN10142-12B1	U2041	48185	GN10415-12B1	U2061	48288	880029	U1002	48029	880120	U6016	48075
GN10168-11B1	U5051	48179	GN10422-12B1	U4009	48171	880032	U1005	48057	880121	U6017	48076
GN10171-12B1	U1020	48111	GN10446-12B1	U5014	48041	880033	U6020	48114	880122	U5020	48065
GN10171-12B2	U1020	48111	GN10450-12B1	U4027	48375	880034	U6008	48023	880123	U4005	48119
GN10174-12B1	U1085	48203	GN10451-12B1	U5034	48131	880035	U6005	48016	880124	U5036	48139
GN10174-12B2	U1086	48204	GN10456-12B1	U5053	48194	880037	U5022	48082	880125	U6022	48126
GN10175-12B1	U1018	48105	GN10459-12B1	U3006	48050	880038	U5010	48034	880126	U5019	48063
GN10177-12B1	U2005	48021	GN10476-12B1	U5039	48147	880039	U6002	48006	880127	U2012	48044
GN10188-11B1	U1075	48324	GN10488-12B1	U2009	48030	880040	U2004	48012	880129	U4007	48149
GN10191-12B1	U4014	48225	GN10492-12B1	U2038	48169	880042	U3013	48175	880130	U6025	48135
GN10195-12B1	U5006	48015	GN10492-12B1	U6055	49086	880043	U2014	48052	880131	U2006	48025
GN10196-12B1	U1006	48059	GN10493-12B1	U4012	48210	880044	U2018	48070	880132	U5040	48154
GN10198-12B1	U6003	48011	GN10494-12B1	U5130	49072	880045	U5005	48009	880133	U5033	48127
GN10199-12B1	U2025	48096	GN10499-12B1	U5063	48229	880046	U5012	48036	880134	U5042	48161
GN10201-12B1	U6007	48022	GN10504-12B1	U5059	48221	880049	U2001	48001	880135	U2033	48150
GN10203-12B1	U5030	48116	GN10504-12B1	U5181	48562	880051	U3008	48060	880136	U1083	48346
GN10204-12B1	U6010	48043	GN10508-12B1	U5093	48283	880052	U1016	48098	880137	U2015	48053
GN10205-12B1	U2008	48027	GN10536-12B1	U5100	48297	880053	U1004	48054	880138	U2039	48170
GN10206-12B1	U5013	48040	GN10547-12B1	U5134	49073	880054	U1036	48158	880139	U2040	48173
GN10207-12B1	U6019	48083	GN10554-12B1	U2037	48167	880055	U1022	48113	880140	U2048	48209
GN10208-12B1	U5011	48035	GN10571-12B1	U5055	48206	880056	U2019	48078	880141	U2035	48160
GN10210-12B1	U5009	48033	GN10590-12B1	U5067	48239	880057	U1006	48059	880142	U1034	48152
GN10210-12B1	U5055	48206	GN10605-12B1	U5101	48317	880058	U2007	48026	880143	U2042	48189
GN10211-12B1	U2006	48025				880059	U1037	48176	880145	U4006	48134
GN10212-12B1	U2016	48056				880060	U3005	48028	880151	U2031	48142
GN10219-12B1	U5061	48226	DENSO	NGK → STOCK No.		880061	U1003	48039	880153	U6001	48004
GN10220-12B1	U2055	48254	DIC-0100	U5029	48107	880062	U3010	48085	880155	U5054	48201
GN10227-11B1	U5031	48120	DIC-0101	U5027	48095	880063	U6003	48011	880156	U2025	48096
GN10227-12B1	U5038	48144	DIC-0102	U5052	48184	880064	U5015	48042	880157	U2027	48106
GN10234-12B1	U6041	48406	DIC-0104	U5068	48240	880065	U5014	48041	880160	U5111	48331
GN10235-12B1	U5117	48337	DIC-0105	U5099	48295	880066	U5017	48047	880161	U5113	48333
GN10236-12B1	U5003	48005	DIC-0106	U4008	48157	880067	U5026	48091	880162	U2036	48166
GN10239-12B1	U6021	48124	DIC-0107	U4014	48225	880068	U5018	48061	880165	U1023	48115
GN10240-12B1	U5008	48031	DIC-0108	U4022	48313	880070	U1028	48129	880166	U5006	48015
GN10246-11B1	U5123	48350	DIC-0109	U4030	48378	880071	U5027	48095	880169	U5050	48177
GN10257-12B1	U2019	48078	DIC-0110	U2066	48315	880072	U1013	48093	880171	U2043	48193
GN10262-12B1	U2015	48053	DIC-0111	U2063	48290	880073	U6009	48032	880172	U6029	48178
GN10263-12B1	U3010	48085	DIC-0112	U2048	48209	880074	U2010	48037	880173	U6030	48192
GN10265-12B1	U2027	48106	DIC-0113	U2051	48230	880075	U2021	48080	880174	U6028	48159
GN10266-12B1	U6037	48048	DIC-0114	U2075	48370	880076	U5032	48122	880175	U5030	48116
GN10286-12B1	U1091	48363	DIC-0115	U2066	48287	880078	U6007	48022	880176	U6026	48146
GN10294-12B1	U5022	48082	DIC-0116	U1028	48129	880079	U4004	48104	880179	U1074	48311
GN10301-12B1	U4011	48208	DIC-0117	U2062	48289	880080	U6010	48043	880180	U4026	48018
GN10302-12B1	U4010	48183				880081	U5004	48008	880181	U5059	48221
GN10303-12B1	U4006	48134	ELTA - see LUCAS			880082	U6023	48128	880181	U5181	48562
GN10307-12B1	U4021	48294				880084	U5021	48073	880182	U2020	48079
GN10309-12B1	U5049	48174	ERA	NGK → STOCK No.		880086	U6012	48051	880183	U1084	48357
GN10310-12B1	U5105	48322	880001	U1001	48000	880087	U6014	48072	880185	U1059	48253
GN10312-12B1	U5027	48095	880002	U1001	48000	880089	U5044	48163	880191	U4001	48055
GN10313-12B1	U5052	48184	880003	U2003	48010	880090	U1030	48137	880192	U1023	48115
GN10314-12B1	U5029	48107	880004	U2003	48010	880091	U2038	48169	880193	U2001	48001
GN10315-12B1	U5090	48278	880005	U2011	48038	880093	U6055	49086	880194	U5095	48285
GN10317-12B1	U5043	48162	880006	U5002	48003	880094	U5048	48172	880195	U2024	48087
GN10318-12B1	U4008	48157	880007	U5003	48005	880099	U6033	48234	880198	U6027	48151
GN10319-12B1	U6004	48014	880008	U3001	48013	880095	U5008	48031	880199	U2032	48145
GN10324-12B1	U5081	48266	880009	U5001	48002	880096	U6006	48017	880200	U5055	48206
GN10327-12B1	U5083	48268	880010	U5028	48102	880097	U3004	48024	880201	U5051	48179
GN10329-12B1	U6022	48126	880011	U5035	48136	880098	U5041	48155	880207	U1024	48117
GN10332-12B1	U6031	48205	880012	U1008	48064	880100	U1035	48156	880208	U2030	48133
GN10334-12B1	U5033	48127	880013	U2017	48067	880101	U6019	48083	880211	U2028	48108
GN10336-12B1	U5032	48122	880014	U2009	48030	880102	U5047	48168	880213	U5043	48162
GN10337-12B1	U5036	48139	880015	U2016	48056	880103	U2008	48027	880216	U5074	48252
GN10338-12B1	U2024	48087	880016	U6012	48051	880107	U5009	48033	880221	U1027	48125
GN10350-12B1	U5092	48281	880017	U6011	48045	880107	U5055	48206	880222	U5092	48281
GN10351-12B1	U1035	48156	880018	U3009	48068	880108	U5016	48046	880225	U1021	48112
GN10356-12B1	U3018	48280	880019	U3007	48058	880110	U3006	48050	880226	U4002	48100
			880020	U3002	48019						

ERA	NGK → STOCK No.		FACET	NGK → STOCK No.		FACET	NGK → STOCK No.		FAE	NGK → STOCK No.	
880227	U5038	48144	9.6063	U1072	48309	9.6326	U5015	48042	80247	U5009	48033
880230	U1017	48099	9.6064	U1056	48236	9.6327	U5014	48041	80247	U5055	48206
880236	U1075	48324	9.6068	U2006	48025	9.6329	U5003	48005	80248	U5014	48041
880240	U5025	48089	9.6070	U2020	48079	9.6331	U5006	48015	80250	U1020	48111
880241	U5100	48297	9.6071	U2046	48197	9.6332	U5001	48002	80251	U2039	48170
880242	U5084	48269	9.6073	U1070	48307	9.6333	U5024	48088	80252	U5004	48008
880243	U5029	48107	9.6078	U1023	48115	9.6334	U5020	48065	80254	U4001	48055
880244	U5086	48273	9.6083	U1077	48340	9.6335	U5011	48035	80256	U5010	48034
880245	U5052	48184	9.6088	U2009	48030	9.6336	U5013	48040	80257	U6010	48043
880246	U5072	48245	9.6089	U2017	48067	9.6337	U5046	48165	80260	U1007	48062
880248	U1050	48211	9.6091	U1083	48346	9.6342	U5018	48061	80261	U1002	48029
880253	U1039	48181	9.6094	U1069	48306	9.6345	U5022	48082	80262	U1005	48057
880254	U5031	48120	9.6096	U3008	48060	9.6350	U6001	48004	80264	U1012	48092
880255	U5090	48278	9.6098	U1014	48094	9.6357	U5051	48179	80265	U1008	48064
880256	U5065	48235	9.6099	U1013	48093	9.6358	U5090	48278	80301	U5090	48278
880257	U5068	48240	9.6101	U1038	48180	9.6359	U5027	48095			
880258	U5099	48295	9.6103	U1018	48105	9.6361	U5029	48107			
880259	U5067	48239	9.6106	U1045	48198	9.6366	U5052	48184	FEBI	NGK → STOCK No.	
880263	U1015	48097	9.6113	U1016	48098	9.6374	U5002	48003	17194	U1001	48000
880264	U5097	48292	9.6114	U1004	48054	9.6375	U5009	48033	21525	U2019	48078
880267	U5013	48040	9.6115	U1017	48099	9.6375	U5055	48206	21526	U3003	48020
880268	U5024	48088	9.6116	U1015	48097	9.6381	U2012	48044	22038	U5002	48003
880270	U5011	48035	9.6119	U1028	48129	9.6381	U2012	48044	22389	U6002	48006
880272	U5098	48293	9.6121	U1024	48117	9.6383	U6021	48124	23187	U6003	48011
880274	U5094	48284	9.6121	U1024	48117	9.6387	U5117	48337	23260	U5014	48041
880275	U5118	48338	9.6128	U1026	48123	9.6389	U5043	48162	24108	U5022	48082
880276	U5049	48174	9.6129	U1021	48112	9.6407	U6025	48135	24435	U5008	48031
880277	U5077	48258	9.6133	U1036	48158	9.6418	U2028	48108	24500	U5006	48015
880278	U5096	48286	9.6152	U1039	48181	9.8104	U1032	48143	24996	U6008	48023
880284	U5114	48334	9.6153	U1040	48182	9.8114	U1001	48000	24997	U6005	48016
880287	U2013	48049	9.6160	U1050	48211	9.8116	U1003	48039	27470	U5003	48005
880288	U1011	48090	9.6160	U2047	48202	9.8120	U2003	48010	28108	U6001	48004
880291	U5091	48279	9.6172	U2016	48056	9.8123	U1035	48156	28148	U2021	48080
880293	U5037	48140	9.6173	U2015	48053				30266	U1028	48129
880294	U5089	48276	9.6175	U3005	48028	FAE	NGK → STOCK No.		36177	U2010	48037
880295	U2023	48086	9.6183	U1034	48152	80200	U1001	48000	36430	U6021	48124
880296	U2005	48021	9.6184	U1022	48113	80201	U5002	48003	37421	U6039	48404
880298	U5073	48247	9.6185	U1043	48188	80202	U5003	48005			
880300	U5115	48335	9.6187	U1075	48324	80203	U5001	48002	FERRARI	NGK → STOCK No.	
880302	U5061	48226	9.6189	U2029	48110	80204	U3002	48019	134386	U2006	48025
880307	U1018	48105	9.6207	U2030	48133	80205	U3003	48020			
880312	U5112	48332	9.6213	U5040	48154	80206	U6036	48007	FIAT GROUP	NGK → STOCK No.	
880314	U5087	48274	9.6214	U5047	48168	80207	U2009	48030	07646975	U1025	48121
880317	U4014	48225	9.6216	U4026	48018	80208	U6005	48016	07753777	U1025	48121
880322	U6035	48318	9.6228	U1044	48191	80209	U6002	48006	115013	U1025	48121
880329	U5088	48275	9.6241	U1002	48029	80210	U2004	48012	1164207900	U1079	48342
880333	U5076	48257	9.6242	U1047	48200	80211	U4026	48018	116426507900	U1079	48342
880335	U5053	48194	9.6244	U1059	48253	80212	U3006	48050	4158493	U1079	48342
880336	U5069	48241	9.6245	U2014	48052	80213	U2005	48021	4386221	U1068	48305
880338	U5039	48147	9.6247	U1020	48111	80214	U2001	48001	4439396	U3013	48175
			9.6254S	U5004	48008	80215	U5012	48036	4460205	U1041	48186
			9.6255	U3009	48068	80216	U5005	48009	46403328	U5047	48168
			9.6256	U3007	48058	80217	U3001	48013	46410164	U2004	48012
			9.6265	U2019	48078	80218	U2003	48010	46446039	U2014	48052
			9.6274	U1006	48059	80219	U1003	48039	46460582	U5028	48102
			9.6276	U3002	48019	80220	U3009	48068	46467542	U5016	48046
			9.6277	U2007	48026	80221	U3007	48058	46469863	U4007	48149
			9.6278	U3003	48020	80222	U2007	48026	46472440	U2014	48052
			9.6282	U5016	48046	80223	U2016	48056	46473849	U5035	48136
			9.6284	U5035	48136	80224	U6003	48011	46480361	U2014	48052
			9.6286	U4003	48103	80226	U6008	48023	46543562	U3001	48013
			9.6287	U4007	48149	80227	U4003	48103	46548037	U3001	48013
			9.6289	U2032	48145	80229	U4004	48104	46755605	U4004	48104
			9.6293	U2033	48150	80231	U5019	48063	46776830	U5048	48172
			9.6294	U1037	48176	80232	U3008	48060	467772086	U5010	48034
			9.6298	U6007	48022	80233	U5018	48061	46777286	U5010	48034
			9.6299	U6002	48006	80234	U3005	48028	46777287	U5048	48172
			9.6300	U6019	48083	80235	U6004	48014	46777288	U5018	48061
			9.6303	U6008	48023	80237	U6012	48051	46790073	U3001	48013
			9.6305	U6005	48016	80239	U5022	48082	46794782	U5042	48161
			9.6313	U5005	48009	80240	U5015	48042	477084200	U1025	48121
			9.6314	U3010	48085	80241	U1013	48093	504142675	U5018	48061
			9.6317	U3004	48024	80242	U5027	48095	510897	U1079	48342
			9.6323	U2038	48169	80244	U5032	48122	55180004	U5010	48034
			9.6323	U6055	49086	80245	U1037	48176	55200112	U2038	48169

FUEL PARTS	NGK → STOCK No.	
CU1055	U1022	48113
CU1056	U2040	48173
CU1057	U2042	48189
CU1058	U2039	48170
CU1059	U2035	48160
CU1060	U2036	48166
CU1062	U2052	48249
CU1063	U1004	48054
CU1064	U1016	48098
CU1065	U1024	48117
CU1066	U1017	48099
CU1067	U1036	48158
CU1069	U5056	48207
CU1070	U3008	48060
CU1071	U1001	48000
CU1072	U1003	48039
CU1073	U2003	48010
CU1074	U2024	48087
CU1078	U2013	48049
CU1079	U5022	48082
CU1080	U2062	48289
CU1081	U6005	48016
CU1082	U5003	48005
CU1083	U2011	48038
CU1085	U2019	48078
CU1086	U5010	48034
CU1087	U1038	48180
CU1089	U5035	48136
CU1090	U5028	48102
CU1091	U2007	48026
CU1092	U5002	48003
CU1093	U2061	48288
CU1094	U4010	48183
CU1096	U1083	48346
CU1097	U2015	48053
CU1098	U6028	48159
CU1099	U1029	48132
CU1100	U1025	48121
CU1101	U1009	48066
CU1102	U1026	48123
CU1104	U1079	48342
CU1105	U3001	48013
CU1106	U5012	48036
CU1107	U1077	48340
CU1108	U1076	48339
CU1110	U3005	48028
CU1113	U1047	48200
CU1114	U6020	48114
CU1115	U6003	48011
CU1116	U2043	48193
CU1117	U6007	48022
CU1119	U1006	48059
CU1120	U4001	48055
CU1121	U2001	48001
CU1122	U2030	48133
CU1123	U4003	48103
CU1124	U4007	48149
CU1130	U6037	48048
CU1131	U5047	48168
CU1133	U5040	48154
CU1134	U4002	48100
CU1136	U4005	48119
CU1137	U5045	48164
CU1139	U6036	48007
CU1140	U5048	48172
CU1143	U5018	48061
CU1144	U6012	48051
CU1145	U6025	48135
CU1146	U6006	48017
CU1147	U3004	48024
CU1148	U6026	48146
CU1149	U1059	48253
CU1150	U4012	48210
CU1151	U2018	48070

FUEL PARTS	NGK → STOCK No.	
CU1154	U2021	48080
CU1155	U5006	48015
CU1157	U5014	48041
CU1160	U5017	48047
CU1163	U1028	48129
CU1164	U5016	48046
CU1165	U6009	48032
CU1166-OE	U6023	48128
CU1168	U5005	48009
CU1169	U2026	48101
CU1170	U5041	48155
CU1171	U5055	48206
CU1172	U6004	48014
CU1174	U1035	48156
CU1175	U4026	48018
CU1177	U2020	48079
CU1178	U5027	48095
CU1179	U5011	48035
CU1181	U2008	48027
CU1182	U4014	48225
CU1183	U5030	48116
CU1184	U5021	48073
CU1185	U2032	48145
CU1186	U6029	48178
CU1189	U4023	48314
CU1190	U6030	48192
CU1191	U6031	48205
CU1192	U3006	48050
CU1194	U2028	48108
CU1195	U4020	48291
CU1196	U1032	48143
CU1198	U5044	48163
CU1199	U6033	48234
CU1200	U5032	48122
CU1202	U6016	48075
CU1203	U5008	48031
CU1204	U6017	48076
CU1205	U6014	48072
CU1206	U6013	48071
CU1207	U2010	48037
CU1208	U5046	48165
CU1209	U5013	48040
CU1210	U5015	48042
CU1211	U5020	48065
CU1214	U6019	48083
CU1215	U1014	48094
CU1216	U5019	48063
CU1218	U6001	48004
CU1219	U6027	48151
CU1220	U6022	48126
CU1221	U5026	48091
CU1222	U5033	48127
CU1224	U1027	48125
CU1225	U1020	48111
CU1227	U5092	48281
CU1229	U5050	48177
CU1230	U2012	48044
CU1231	U6015	48074
CU1234	U1050	48211
CU1236	U6018	48077
CU1237	U2034	48153
CU1238	U2031	48142
CU1239	U6055	49086
CU1240	U5042	48161
CU1242	U5024	48088
CU1244	U1037	48176
CU1245	U5036	48139
CU1246	U5054	48201
CU1247	U2048	48209
CU1248	U2054	48251
CU1250	U2064	48296
CU1251	U4021	48294
CU1252	U2060	48287
CU1253	U2063	48290

FUEL PARTS	NGK → STOCK No.	
CU1254	U5058	48216
CU1255	U5039	48147
CU1256	U5055	48206
CU1257	U2068	48325
CU1258	U5037	48140
CU1259	U1031	48141
CU1260	U4008	48157
CU1261	U2029	48110
CU1262	U1015	48097
CU1264	U1013	48093
CU1265	U3010	48085
CU1266	U5038	48144
CU1267	U5095	48285
CU1268	U2041	48185
CU1273	U5065	48235
CU1274	U1018	48105
CU1274	U1045	48198
CU1275	U5100	48297
CU1279	U1039	48181
CU1282	U2051	48230
CU1283	U5043	48162
CU1287	U5091	48279
CU1288	U5089	48276
CU1289	U6021	48124
CU1289B	U6021	48124
CU1290	U2047	48202
CU1291	U5090	48278
CU1294	U1085	48203
CU1295	U5053	48194
CU1296	U2044	48195
CU1297	U2045	48196
CU1298	U4009	48171
CU1300	U4019	48270
CU1301	U5074	48252
CU1302	U2059	48272
CU1306	U5049	48174
CU1307	U5244	49066
CU1309	U6041	48406
CU1312	U5114	48334
CU1313	U5029	48107
CU1315	U5086	48273
CU1317	U5052	48184
CU1320	U1043	48188
CU1324	U6034	48282
CU1329	U5082	48267
CU1331	U5067	48239
CU1332	U2049	48220
CU1333	U1071	48308
CU1334	U5066	48237
CU1337	U5099	48295
CU1339	U5097	48292
CU1340	U5098	48293
CU1345	U5103	48320
CU1346	U5102	48319
CU1347	U5083	48268
CU1348	U5077	48258
CU1350	U3015	48218
CU1355	U5087	48274
CU1366	U5064	48231
CU1372	U5105	48322
CU1373	U2023	48086
CU1374	U5096	48286
CU1381	U5112	48332
CU1385	U5117	48337
CU1393	U5061	48226
CU1396	U5094	48284
CU1397	U5093	48283
CU1402	U5121	48265
CU1403	U5084	48269
CU1405	U5076	48257
CU1409	U5123	48350
CU1410	U1018	48105
CU1419	U5118	48338
CU1420	U3018	48280

FUEL PARTS	NGK → STOCK No.	
CU1423	U4024	48326
CU1424	U2037	48167
CU1425	U1086	48204
CU1426	U4011	48208
CU1429	U5115	48335
CU1430	U5072	48245
CU1432	U5068	48240
CU1433	U4013	48223
CU1434	U5113	48333
CU1435	U5110	48330
CU1436	U5111	48331
CU1437	U5088	48275
CU1442	U6035	48318
CU1443	U4015	48242
CU1444	U2050	48224
CU1445	U5063	48229
CU1446	U5069	48241
CU1448	U1010	48069
CU1450	U1044	48191
CU1451	U6032	48219
CU1452	U5073	48247
CU1455	U2055	48254
CU1458	U2058	48261
CU1459	U1054	48217
CU1460	U5101	48317
CU1461	U4017	48264
CU1463	U5078	48259
CU1464	U2056	48255
CU1466	U5062	48227
CU1467	U1040	48182
CU1469	U1075	48324
CU1470	U5106	48323
CU1472	U5104	48321
CU1481	U4022	48313
CU1488	U3016	48228
CU1492	U2028	48108
CU1493	U1070	48307
CU1494	U1078	48341
CU1495	U1082	48345
CU1496	U1001	48000
CU1497	U1077	48340
CU1511	U5155	48410
CU1513	U5310	49048
CU1514	U6053	49076
CU1518	U2073	48368
CU1522	U4028	48376
CU1523	U4031	48379
CU1526	U5314	49052
CU1531	U5316	49054
CU1532	U5317	49055
CU1538	U5315	49053
CU1540	U6054	49077
CU1541	U5148	48398
CU1543	U5319	49057
CU1546	U5147	48397
CU1549	U5320	49058
CU1552	U5130	49072
CU1555	U5210	49060
CU1556	U5322	49061
CU1560	U5323	49062
GHIBAUDI	NGK → STOCK No.	
B0001	U5001	48002
B0002	U5002	48003
B0003	U1001	48000
B0004	U5003	48005
B0005	U3001	48013
B0006	U5010	48034
B0007	U6020	48114
B0008	U6036	48007
B0009	U6002	48006
B0010	U5028	48102
B0011	U6003	48011
B0012	U2001	48001

GHIBAUDI	NGK → STOCK No.		GHIBAUDI	NGK → STOCK No.		GHIBAUDI	NGK → STOCK No.		GM	NGK → STOCK No.	
B0013	U3008	48060	B0099	U6023	48128	B0188	U4014	48225	56029129AB	U5121	48265
B0014	U6008	48023	B0100	U6007	48022	B0191	U5031	48120	56029129AF	U5121	48265
B0015	U5022	48082	B0101	U6010	48043	B0192	U4012	48210	6235037	U6025	48135
B0016	U2004	48012	B0103	U2034	48153	B0193	U5052	48184	813597	U1054	48217
B0017	U6005	48016	B0104	U5006	48015	B0195	U5084	48269	814541	U1054	48217
B0018	U2018	48070	B0105	U5004	48008	B0196	U5055	48206	820133	U1054	48217
B0019	U3002	48019	B0109	U5009	48033	B0197	U5051	48179	823294	U1054	48217
B0020	U2014	48052	B0109	U5055	48206	B0199	U1024	48117	824728	U1054	48217
B0021	U5035	48136	B0110	U5016	48046	B0200	U6028	48159	824987	U1054	48217
B0022	U3009	48068	B0111	U2006	48025	B0202	U2066	48315	88921253	U2049	48220
B0023	U2003	48010	B0112	U3006	48050	B0203	U4019	48270	88921262	U2047	48202
B0024	U3003	48020	B0113	U1079	48342	B0204	U5034	48131	88921326	U2050	48224
B0025	U3005	48028	B0114	U1033	48148				88921374	U2018	48070
B0026	U2011	48038	B0115	U1031	48141				90140186	U1069	48306
B0027	U5018	48061	B0116	U3009	48068				90173708	U6031	48205
B0028	U6012	48051	B0117	U3007	48058	GM	NGK → STOCK No.		90240252	U1069	48306
B0029	U3007	48058	B0118	U6015	48074	88921336	U4024	48326	90277970	U1083	48346
B0030	U6011	48045	B0119	U6013	48071	90348296	U1083	48346	90358386	U2043	48193
B0031	U1005	48057	B0120	U6018	48077	90350021	U1083	48346	90424480	U6025	48135
B0032	U5006	48015	B0121	U6016	48075	90350929	U1082	48345	90443900	U2015	48053
B0033	U5015	48042	B0122	U6017	48076	90458250-01	U2016	48056	90444184	U2043	48193
B0034	U2009	48030	B0123	U5020	48065	90490427	U2068	48325	90449572	U2015	48053
B0035	U2007	48026	B0124	U5036	48139	96415010	U6035	48318	90449739	U1005	48057
B0036	U2005	48021	B0125	U6022	48126	96453420	U2062	48289	90449740	U1002	48029
B0037	U2016	48056	B0126	U5019	48063	01103759	U3015	48218	90458250	U2016	48056
B0038	U5014	48041	B0127	U2012	48044	01103962	U3015	48218	90492255	U2025	48096
B0039	U1076	48339	B0128	U4003	48103	09119567	U6003	48011	90506102	U2032	48145
B0040	U1007	48062	B0129	U2040	48173	10450424	U2018	48070	90510386	U1005	48057
B0041	U6004	48014	B0130	U2048	48209	10457075	U2004	48012	90510387	U1002	48029
B0042	U6009	48032	B0131	U2035	48160	10457870	U2021	48080	90511450	U2025	48096
B0043	U2019	48078	B0132	U2061	48288	10467067	U3015	48218	90532618	U6007	48022
B0044	U1003	48039	B0133	U4026	48018	10468391	U3015	48218	90536194	U6003	48011
B0046	U2038	48169	B0136	U5048	48172	10472401	U3015	48218	90541062	U2027	48106
B0046	U6055	49086	B0137	U2033	48150	10477208	U1054	48217	90543059	U6007	48022
B0047	U6033	48234	B0138	U4005	48119	10477602	U3015	48218	90543253	U6010	48043
B0048	U2021	48080	B0139	U4007	48149	10490192	U2018	48070	90543830	U2068	48325
B0049	U5027	48095	B0140	U6025	48135	10495121	U3015	48218	90560110	U6010	48043
B0050	U5021	48073	B0142	U5040	48154	10497771	U3015	48218	90563160	U2027	48106
B0052	U1008	48064	B0143	U5033	48127	1103662	U3015	48218	90564334	U6028	48159
B0053	U5005	48009	B0145	U2015	48053	1103872	U2004	48012	90584336	U6029	48178
B0054	U6014	48072	B0146	U2039	48170	1103905	U2004	48012	90584337	U6030	48192
B0055	U4004	48104	B0147	U2031	48142	1103982	U2004	48012	91159996	U5001	48002
B0056	U6012	48051	B0148	U4010	48183	1104003	U2004	48012	9118114	U6029	48178
B0057	U1023	48115	B0149	U2027	48106	1104038	U2018	48070	9118115	U6030	48192
B0058	U5008	48031	B0150	U4001	48055	1104070	U6026	48146	9153250	U6027	48151
B0060	U2017	48067	B0151	U2024	48087	1104082	U6001	48004	9195819	U6028	48159
B0061	U1006	48059	B0152	U6026	48146	1104091	U6021	48124	9198834	U6025	48135
B0064	U1029	48132	B0153	U5042	48161	1115315	U1054	48217	9268344	U1010	48069
B0065	U1030	48137	B0154	U6001	48004	1115317	U1054	48217	9293480	U1064	48301
B0066	U1009	48066	B0156	U5054	48201	1115324	U1054	48217	93172030	U6027	48151
B0067	U1026	48123	B0157	U2025	48096	1115467	U1054	48217	93173708	U6031	48205
B0068	U1012	48092	B0160	U5059	48221	1115468	U1054	48217	93177212	U6019	48083
B0069	U1002	48029	B0160	U5181	48562	1115491	U1054	48217	93180806	U6022	48126
B0073	U3013	48175	B0163	U1034	48152	1208039	U5049	48174	94136766	U1028	48129
B0075	U1016	48098	B0164	U4006	48134	1228064	U1064	48301	94404545	U1013	48093
B0076	U1004	48054	B0165	U2042	48189	12566569	U5049	48174	94853695	U1013	48093
B0077	U1036	48158	B0167	U2052	48249	12567686	U6026	48146	96165049	U1031	48141
B0078	U1022	48113	B0167	U2052	48249	12569342	U6026	48146	96253555	U2031	48142
B0079	U3010	48085	B0168	U2060	48287	12580537	U6026	48146	96291054	U2034	48153
B0080	U5026	48091	B0169	U2062	48289	12583514	U5049	48174	96320818	U1028	48129
B0081	U1047	48200	B0171	U2063	48290	12613051	U5049	48174	96336522	U1028	48129
B0082	U1028	48129	B0172	U2064	48296	12629037	U5049	48174	96350585	U2018	48070
B0083	U1013	48093	B0173	U2054	48251	1841856	U1054	48217	96476979	U6053	49076
B0084	U2010	48037	B0174	U2006	48025	1871561	U1054	48217	E586A	U2018	48070
B0085	U5032	48122	B0175	U2030	48133	19005205	U1054	48217			
B0088	U5044	48163	B0176	U6030	48192	19005212	U6002	48006			
B0089	U1030	48137	B0179	U5030	48116	19005212156300	U6002	48006	HELLA	NGK → STOCK No.	
B0091	U6006	48017	B0180	U4021	48294	19017110	U1086	48204	5DA006623671	U1032	48143
B0092	U3004	48024	B0181	U6029	48178	24420622	U6022	48126	5DA193175291	U5073	48427
B0093	U5041	48155	B0182	U5111	48331	25184291	U2018	48070	5DA193175321	U5091	48279
B0095	U1035	48156	B0183	U5113	48333	25186686	U6053	49076	5DA193175381	U5073	48427
B0096	U6019	48083	B0184	U2036	48166	3474200	U1010	48069	5DA193175401	U2005	48021
B0097	U5047	48168	B0185	U3017	48233	55350843	U6031	48205	5DA193175501	U5002	48003
B0098	U2008	48027	B0186	U2020	48079	56029129AA	U5121	48265	5DA193175581	U2018	48070
			B0187	U1059	48253				5DA193175651	U2004	48012

HELLA	NGK → STOCK No.	
5DA193175811	U5091	48279
5DA358000001	U5011	48035
5DA749475151	U2005	48021
5DA749475191	U2004	48012
5DA749475241	U2018	48070
5DA749475351	U6037	48048
5DA749475371	U2029	48110
5DA749475471	U2010	48037
5DA749475511	U5028	48102
5DA749475601	U6013	48071
5DA749475711	U5011	48035
5DA749475861	U5002	48003
5DA749475891	U5029	48107
5DA749475901	U5052	48184

HERTH + BUSS	NGK → STOCK No.	
19020022	U2016	48056
19050007	U5005	48009
19050023	U6036	48007
19050049	U6001	48004
J5372001	U5090	48278

HONDA	NGK → STOCK No.	
30500634015	U1056	48236
30500634632	U1056	48236
30500634671	U1056	48236
30500634672	U1056	48236
30500659005	U1056	48236
30500P01005	U1015	48097
30500P0AA01	U1020	48111
30500P0HA01	U1020	48111
30500PAAA01	U1020	48111
30500PCA003	U1020	48111
30500PDAE01	U1020	48111
30500PM3005	U1015	48097
30500PM3015	U1015	48097
30500PM5A02	U1016	48098
30500PM5A03	U1016	48098
30500PR4A02	U1017	48099
30500PR4A03	U1017	48099
30500PT0005	U1015	48097
30510P73A01	U1004	48054
30510P73A02	U1004	48054
30510PT2006	U1004	48054
30520P8EA01	U5051	48179
30520P8FA01	U5051	48179
30520P8FA02	U5051	48179
30520PDFE00	U2006	48025
30520PDKA01	U5051	48179
30520PGKA01	U5051	48179
30520PNA007	U5099	48295
30520PNC004	U5064	48231
30520PT3A02	U1075	48324
30520PVFA01	U5051	48179
30520PVJA01	U5051	48179
30520PVVA003	U5097	48292
30520RAA007	U5099	48295
30520RB0003	U5134	49073
30520RB00032	U5134	49073
30520RB0013	U5134	49073
30520RB00130	U5134	49073
30520RB0S01	U5134	49073
30520RB0S010	U5134	49073
30520RBJS01	U5225	49070
30520RBJS010	U5225	49070
30520RCAA01	U5051	48179
30520RCAA02	U5051	48179
30520RDJA01	U5051	48179
30520RNAA01	U5081	48266
30520RRA007	U5099	48295
30521PWA003	U5098	48293
30521PWAS01	U5098	48293

HITACHI	NGK → STOCK No.	
133853	U6017	48076
133859	U5021	48073
133906	U5123	48350
133920	U5111	48331
133800	U5001	48002
133801	U5018	48061
133802	U5026	48091
133803	U5008	48031
133804	U5005	48009
133805	U5004	48008
133806	U5003	48005
133807	U5002	48003
133808	U5015	48042
133809	U6002	48006
133810	U6003	48011
133811	U5012	48036
133812	U5006	48015
133814	U4026	48018
133815	U6007	48022
133816	U6010	48043
133817	U6008	48023
133818	U6005	48016
133819	U6004	48014
133820	U6011	48045
133821	U6012	48051
133822	U6006	48017
133824	U6033	48234
133825	U5055	48206
133827	U5010	48034
133828	U5022	48082
133829	U5016	48046
133830	U5017	48047
133831	U5014	48041
133832	U6001	48004
133833	U5025	48089
133834	U5013	48040
133836	U5015	48042
133837	U4001	48055
133838	U4002	48100
133839	U6019	48083
133840	U4003	48103
133841	U4004	48104
133842	U6013	48071
133843	U6014	48072
133844	U5027	48095
133845	U5024	48088
133846	U5029	48107
133847	U5020	48065
133848	U5011	48035
133849	U5028	48102
133850	U4009	48171
133851	U5066	48237
133852	U5019	48063
133854	U6021	48124
133855	U6029	48178
133856	U6030	48192
133857	U5046	48165
133858	U5032	48122
133860	U5036	48139
133861	U4007	48149
133862	U6016	48075
133863	U5043	48162
133864	U5049	48174
133865	U5047	48168
133866	U6022	48126
133901	U5119	48347
133906	U5123	48350
133907	U5061	48226
133909	U5054	48201
133910	U5097	48292
133913	U5051	48179
133919	U5111	48331
133921	U5113	48333
133922	U5110	48330

HITACHI	NGK → STOCK No.	
133929	U5147	48397
133943	U5225	49070
134003	U5134	49073
134016	U6014	48406
134032	U6053	49076
134054	U5319	49057
138077	U1032	48143
138416	U1003	48039
138419	U1001	48000
138425	U2003	48010
138430	U2004	48012
138434	U2024	48087
138435	U6037	48048
138437	U2026	48101
138438	U2011	48038
138440	U2010	48037
138441	U2013	48049
138709	U3004	48024
138710	U3010	48085
138711	U3006	48050
138712	U6036	48007
138713	U2028	48108
138714	U2040	48173
138715	U1074	48311
138716	U1023	48115
138718	U2048	48209
138730	U3001	48013
138732	U1025	48121
138735	U1026	48123
138736	U3005	48028
138738	U3008	48060
138739	U2014	48052
138750	U1012	48092
138752	U1009	48066
138754	U1007	48062
138756	U2017	48067
138757	U3009	48068
138758	U3007	48058
138759	U3002	48019
138760	U2009	48030
138761	U2025	48096
138762	U2016	48056
138764	U2007	48026
138765	U2019	48078
138766	U3003	48020
138768	U2027	48106
138780	U1005	48057
138781	U1002	48029
138790	U2015	48053
138793	U2006	48025
138800	U2005	48021
138802	U2020	48079
138803	U2001	48001
138804	U2021	48080
138805	U2018	48070
138808	U2008	48027
138809	U2012	48044
138811	U2001	48001
138812	U1004	48054
138813	U1017	48099
138814	U1016	48098
138815	U1015	48097
138817	U2023	48086
138820	U2073	48368
138843	U1034	48152
138844	U1011	48090
138850	U1028	48129
138865	U1013	48093
138866	U1014	48094
138868	U1018	48105
138750	U1012	48092
2503929	U5147	48397
2503943	U5225	49070

HUCO - see HITACHI		
HYUNDAI/KIA	NGK → STOCK No.	
OK01118100	U2006	48025
OK01318100	U4020	48291
OK2011810XB	U1059	48253
OK2011810XC	U1059	48253
OK24718100A	U4021	48294
OK2A318100A	U4019	48270
OK30A1810X	U2064	48296
OK30E1810X	U2061	48288
OK9BV1810X	U2054	48251
2730039000	U4023	48314
2730039050	U4023	48314
2730039700	U4022	48313
2730102100	U2066	48315
2730102502	U1037	48176
2730102600	U2039	48170
2730102700	U2063	48290
2730102710	U2063	48290
2730103110	U5310	49048
273012B100	U5317	49055
2730122040	U2040	48173
2730122050	U2040	48173
2730122600	U2048	48209
2730123003	U2035	48160
2730123500	U2036	48166
2730123510	U2036	48166
2730123700	U2051	48230
2730123710	U2051	48230
2730123900	U2075	48370
2730124510	U1022	48113
2730124520	U1022	48113
2730126080	U2059	48272
2730126600	U2060	48287
2730126640	U5073	48247
273012B000	U5072	48245
273012B010	U5067	48239
2730132800	U1034	48152
2730132810	U1034	48152
2730132820	U1034	48152
2730133010	U2042	48189
2730133020	U2042	48189
2730137100	U2076	48371
2730137110	U2052	48249
2730137120	U2052	48249
2730137150	U2077	48372
2730138020	U4006	48134
273013C000	U5087	48274
273013E100	U5074	48252
273013E400	U5088	48275
2731021020	U1076	48339
2731024000	U1022	48113
INFINITI - see NISSAN		
INNOCENTI	NGK → STOCK No.	
39322140	U1079	48342
553221601	U1056	48236
INTERMOTOR	NGK → STOCK No.	
11000	U1061	48298
11010	U1062	48299
11040	U1079	48342
11070	U1056	48236
11105	U1079	48342
11110	U1062	48299
11111	U1063	48300
11170	U1064	48301
11220	U1065	48302
11270	U3017	48233
11280	U1066	48303
11330	U1077	48340
11350	U1077	48340
11380	U1068	48305

INTERMOTOR	NGK → STOCK No.		INTERMOTOR	NGK → STOCK No.		INTERMOTOR	NGK → STOCK No.		INTERMOTOR	NGK → STOCK No.	
11390	U1069	48306	12435	U2058	48261	12670	U1040	48182	12769	U5040	48154
11400	U1070	48307	12439	U4017	48264	12672	U1050	48211	12770	U5044	48163
11410	U1076	48339	12440	U5121	48265	12677	U1003	48039	12771	U5031	48120
11420	U1078	48341	12441	U5081	48266	12678	U2016	48056	12772	U2008	48027
11480	U1080	48343	12442	U5082	48267	12679	U3005	48028	12773	U5026	48091
11481	U1081	48344	12444	U5083	48268	12683	U1034	48152	12774	U5027	48095
11490	U1082	48345	12446	U5084	48269	12692	U1044	48191	12775	U2028	48108
11500	U1083	48346	12447	U5101	48317	12698	U1047	48200	12776	U6033	48234
11510	U1071	48308	12449	U4019	48270	12699	U2005	48021	12777	U5041	48155
11770	U1072	48309	12451	U6035	48318	12700	U2014	48052	12778	U5006	48015
11791	U1073	48310	12452	U2059	48272	12701	U3009	48068	12779	U1031	48141
12010	U1010	48069	12454	U5086	48273	12702	U3007	48058	12780	U5015	48042
12100	U2073	48368	12457	U5087	48274	12705	U2019	48078	12781	U2001	48001
12101	U5153	48408	12458	U5088	48275	12707	U1006	48059	12782	U5019	48063
12102	U5154	48409	12459	U5089	48276	12709	U1037	48176	12783	U5015	48042
12103	U2076	48371	12461	U2029	48110	12710	U2030	48133	12784	U6026	48146
12104	U4030	48378	12462	U5102	48319	12711	U5001	48002	12785	U5048	48172
12111	U1018	48105	12463	U5103	48320	12712	U2025	48096	12786	U5014	48041
12113	U5309	49047	12467	U2001	48001	12713	U2027	48106	12787	U5045	48164
12116	U5119	48347	12468	U5104	48321	12714	U2001	48001	12788	U5011	48035
12119	U2074	48369	12469	U5105	48322	12715	U2001	48001	12789	U6055	49086
12120	U2075	48370	12470	U5106	48323	12716	U4003	48103	12790	U5020	48065
12124	U2022	48081	12471	U1075	48324	12717	U4007	48149	12791	U5046	48165
12126	U6039	48404	12472	U2068	48325	12718	U1043	48188	12792	U5013	48040
12128	U6053	49076	12473	U5066	48237	12719	U6008	48023	12793	U2034	48153
12129	U5155	48410	12474	U4024	48326	12720	U6005	48016	12794	U6013	48071
12130	U5156	48411	12479	U5110	48330	12721	U6010	48043	12795	U6018	48077
12133	U2077	48372	12480	U5111	48331	12722	U6007	48022	12796	U6015	48074
12137	U2013	48049	12481	U5112	48332	12723	U6002	48006	12797	U6022	48126
12138	U3020	48374	12482	U5113	48333	12724	U6003	48011	12798	U5036	48139
12144	U4027	48375	12484	U5114	48334	12725	U6036	48007	12799	U5033	48127
12145	U4028	48376	12486	U5115	48335	12726	U2011	48038	12800	U6025	48135
12146	U4031	48379	12498	U6041	48406	12727	U5002	48003	12801	U5005	48009
12153	U5314	49052	12589	U3002	48019	12728	U5003	48005	12802	U6001	48004
12154	U6042	48407	12596	U2007	48026	12729	U5028	48102	12803	U5050	48177
12155	U5147	48397	12598	U2015	48053	12730	U5035	48136	12804	U6030	48192
12166	U6054	49077	12599	U2032	48145	12731	U6040	48405	12805	U6029	48178
12167	U5148	48398	12601	U1008	48064	12732	U6011	48045	12806	U2043	48193
12175	U5130	49072	12602	U1030	48137	12733	U5022	48082	12807	U2012	48044
12179	U5210	49060	12603	U1041	48186	12734	U2018	48070	12808	U2036	48166
12183	U5323	49062	12606	U5004	48008	12735	U5032	48122	12809	U5054	48201
12185	U5181	48562	12607	U3003	48020	12736	U4026	48018	12810	U4010	48183
12202	U1002	48029	12608	U5012	48036	12737	U5010	48034	12811	U2031	48142
12203	U1005	48057	12609	U5005	48009	12738	U4005	48119	12812	U4006	48134
12301	U1012	48092	12610	U1024	48117	12739	U4001	48055	12813	U2042	48189
12302	U1007	48062	12611	U1021	48112	12740	U6020	48114	12814	U2035	48160
12303	U1029	48132	12613	U2009	48030	12741	U5018	48061	12815	U2040	48173
12304	U1009	48066	12614	U2005	48021	12742	U1028	48129	12816	U2039	48170
12306	U1012	48092	12615	U1084	48357	12743	U5047	48168	12817	U5034	48131
12400	U5067	48239	12616	U2017	48067	12744	U5016	48046	12818	U5037	48140
12401	U5068	48240	12617	U1022	48113	12745	U4004	48104	12819	U5030	48116
12402	U5069	48241	12618	U1016	48098	12746	U5038	48144	12820	U5025	48089
12403	U4015	48242	12619	U3001	48013	12747	U6009	48032	12821	U5014	48041
12406	U5072	48245	12620	U1025	48121	12748	U2021	48080	12822	U4002	48100
12408	U5073	48247	12622	U5012	48036	12749	U6004	48014	12824	U5145	48395
12409	U4022	48313	12623	U2006	48025	12750	U6012	48051	12825	U5052	48184
12411	U5123	48350	12624	U1036	48158	12751	U3010	48085	12826	U2037	48167
12412	U4023	48314	12626	U1002	48029	12752	U6023	48128	12828	U2047	48202
12413	U2052	48249	12635	U2020	48079	12752OE	U6023	48128	12829	U5042	48161
12414	U2053	48250	12636	U2046	48197	12753	U3006	48050	12830	U5017	48047
12415	U5151	48401	12639	U1023	48115	12754	U2033	48150	12831	U6027	48151
12416	U1028	48129	12646	U3008	48060	12755	U5021	48073	12832	U5043	48162
12418	U2054	48251	12647	U1013	48093	12756	U6014	48072	12833	U5058	48216
12419	U5074	48252	12648	U1014	48094	12757	U1020	48111	12834	U1054	48217
12420	U1059	48253	12649	U1013	48093	12758	U5055	48206	12835	U3015	48218
12421	U2066	48315	12651	U1038	48180	12759	U6028	48159	12836	U2041	48185
12424	U2055	48254	12652	U1018	48105	12760	U6006	48017	12837	U1085	48203
12425	U2056	48255	12653	U1045	48198	12761	U6019	48083	12838	U5053	48194
12428	U2023	48086	12659	U1004	48054	12763	U1027	48125	12839	U6032	48219
12430	U5076	48257	12660	U1017	48099	12764	U2019	48078	12840	U2044	48195
12431	U5149	48399	12661	U1015	48097	12765	U6016	48075	12841	U2049	48220
12432	U5077	48258	12662	U1026	48123	12766	U5008	48031	12842	U1086	48204
12433	U5078	48259	12667	U1033	48148	12767	U6017	48076	12843	U5049	48174
12434	U2057	48260	12669	U1039	48181	12768	U3004	48024	12844	U2045	48196

INTERMOTOR	NGK → STOCK No.		ISUZU	NGK → STOCK No.		KERR NELSON	NGK → STOCK No.		KERR NELSON	NGK → STOCK No.	
12845	U6031	48205	9825135050	U1056	48236	IIS062	U5021	48073	IIS145	U1008	48064
12846	U5055	48206	9825135080	U1079	48342	IIS063	U5055	48206	IIS146	U3006	48050
12847	U4009	48171	9825135090	U1056	48236	IIS064	U6028	48159	IIS147	U3010	48085
12848	U5039	48147				IIS065	U6016	48075	IIS148	U1069	48306
12849	U5244	49066				IIS066	U6017	48076	IIS150	U1010	48069
12850	U5090	48278	JAGUAR	NGK → STOCK No.		IIS067	U5044	48163	IIS151	U2012	48044
12851	U2010	48037	AJ810445	U5082	48267	IIS068	U5031	48120	IIS152	U2035	48160
12852	U5181	48562	AJ83415	U5082	48267	IIS069	U6033	48234	IIS153	U6025	48135
12855	U5051	48179	AJ87644	U5082	48267	IIS070	U5015	48042	IIS154	U1066	48303
12856	U4013	48223	C2S11480	U5083	48268	IIS071	U5019	48063	IIS155	U2019	48078
12857	U5056	48207	C2S42673	U5083	48268	IIS072	U6026	48146	IIS156	U1071	48308
12858	U6021	48124	C2S42751	U5031	48120	IIS073	U5014	48041	IIS157	U2015	48053
12860	U4008	48157	C2S7928	U5083	48268	IIS074	U5045	48164	IIS158	U1023	48115
12861	U5091	48279	DAC2692	U1073	48310	IIS075	U6012	48051	IIS159	U1029	48132
12862	U3018	48280	DAC4608	U1047	48200	IIS076	U2001	48001	IIS160	U5005	48009
12863	U2050	48224	LCA1510AB	U5103	48320	IIS077	U3001	48013	IIS161	U1062	48299
12864	U4011	48208	LHE1510AB	U5045	48164	IIS078	U1001	48000	IIS162	U1078	48341
12865	U4014	48225	LNE1510AB	U5102	48319	IIS079	U1006	48059	IIS163	U1016	48098
12866	U5029	48107	XR827823	U5038	48144	IIS080	U2001	48001	IIS164	U1024	48117
12867	U5061	48226	XR842741	U5031	48120	IIS081	U1018	48105	IIS165	U1013	48093
12868	U5065	48235	XW9312029AB	U5102	48319	IIS082	U1004	48054	IIS166	U2027	48106
12869	U2048	48209				IIS085	U1079	48342	IIS168	U1012	48092
12870	U5062	48227	JEEP - see GM			IIS086	U1056	48236	IIS169	U5050	48177
12871	U3016	48228				IIS087	U5006	48015	IIS170	U5030	48116
12873	U5063	48229	KERR NELSON	NGK → STOCK No.		IIS088	U1076	48339	IIS171	U1025	48121
12874	U2051	48230	IIS001	U5003	48005	IIS089	U2003	48010	IIS172	U6014	48072
12875	U5064	48231	IIS002	U6005	48016	IIS090	U2007	48026	IIS173	U2039	48170
12876	U4012	48210	IIS003	U6008	48023	IIS091	U3002	48019	IIS174	U5036	48139
12877	U5092	48281	IIS004	U5029	48107	IIS092	U2006	48025	IIS175	U1030	48137
12878	U2028	48108	IIS005	U5012	48036	IIS093	U3003	48020	IIS176	U2020	48079
12879	U6034	48282	IIS006	U4026	48018	IIS094	U2005	48021	IIS177	U2032	48145
12880	U5093	48283	IIS008	U4007	48149	IIS095	U2008	48027	IIS178	U1026	48123
12882	U5094	48284	IIS009	U6010	48043	IIS096	U6004	48014	IIS179	U2024	48087
12883	U5095	48285	IIS010	U5001	48002	IIS098	U1005	48057	IIS180	U1037	48176
12884	U5096	48286	IIS011	U4012	48210	IIS099	U6009	48032	IIS181	U5037	48140
12885	U2060	48287	IIS012	U4005	48119	IIS100	U2009	48030	IIS182	U1020	48111
12886	U2061	48288	IIS013	U4003	48103	IIS101	U2016	48056	IIS183	U1031	48141
12887	U2062	48289	IIS014	U5040	48154	IIS102	U3007	48058	IIS184	U2026	48101
12888	U2063	48290	IIS015	U5004	48008	IIS103	U1063	48300	IIS185	U6055	49086
12889	U5117	48337	IIS016	U5047	48168	IIS104	U3005	48028	IIS186	U1015	48097
12890	U5118	48338	IIS017	U4004	48104	IIS105	U6001	48004	IIS187	U6029	48178
12891	U4020	48291	IIS018	U5016	48046	IIS106	U1061	48298	IIS188	U1014	48094
12893	U5097	48292	IIS020	U5022	48082	IIS107	U3008	48060	IIS189	U1043	48188
12894	U5098	48293	IIS021	U5095	48285	IIS108	U5008	48031	IIS190	U5042	48161
12895	U5024	48088	IIS022	U5092	48281	IIS109	U1027	48125	IIS191	U1003	48039
12896	U4021	48294	IIS023	U4008	48157	IIS110	U5013	48040	IIS192	U1022	48113
12897	U5099	48295	IIS026	U5051	48179	IIS111	U3009	48068	IIS193	U1040	48182
12898	U2064	48296	IIS027	U5032	48122	IIS112	U1080	48343	IIS194	U1033	48148
12899	U5100	48297	IIS030	U5027	48095	IIS113	U2017	48067	IIS195	U1064	48301
12907	U1032	48143	IIS031	U6003	48011	IIS114	U2004	48012	IIS197	U6015	48074
12909	U1076	48339	IIS032	U6007	48022	IIS115	U2025	48096	IIS198	U2043	48193
12910	U1032	48143	IIS033	U6002	48006	IIS116	U2014	48052	IIS199	U2045	48196
12916	U1001	48000	IIS034	U5026	48091	IIS117	U2018	48052	IIS200	U1077	48340
12917	U2004	48012	IIS035	U5048	48172	IIS119	U2018	48070	IIS201	U5054	48201
12918	U1003	48039	IIS036	U4001	48055	IIS123	U1083	48346	IIS202	U1038	48180
12919	U2003	48010	IIS037	U5018	48061	IIS124	U5020	48065	IIS203	U6030	48192
12921	U1035	48156	IIS038	U6012	48051	IIS125	U1068	48305	IIS204	U1021	48112
12922	U2024	48087	IIS039	U5025	48089	IIS126	U2021	48080	IIS205	U2040	48173
12923	U2026	48101	IIS041	U5014	48041	IIS127	U2030	48133	IIS206	U1047	48200
12924	U6037	48048	IIS042	U5002	48003	IIS128	U2031	48142	IIS207	U1036	48158
			IIS043	U6011	48045	IIS129	U3004	48024	IIS208	U1084	48357
			IIS046	U5034	48131	IIS130	U6006	48017	IIS209	U1034	48152
ISUZU	NGK → STOCK No.		IIS047	U6019	48083	IIS131	U1002	48029	IIS210	U6013	48071
5813600050	U1079	48342	IIS049	U5035	48136	IIS132	U1028	48129	IIS211	U2036	48166
5862061610	U1020	48111	IIS050	U4006	48134	IIS133	U1070	48307	IIS212	U6021	48124
5862071980	U1020	48111	IIS052	U5017	48047	IIS135	U1081	48344	IIS213	U1039	48181
8011038300	U3015	48218	IIS053	U5033	48127	IIS136	U1009	48066	IIS214	U2034	48153
8011153150	U1054	48217	IIS054	U5041	48155	IIS137	U1065	48302	IIS215	U1050	48211
8011154660	U1054	48217	IIS055	U4002	48100	IIS138	U1082	48345	IIS217	U2042	48189
8104683910	U3015	48218	IIS056	U5010	48034	IIS139	U6022	48126	IIS218	U5055	48206
8104724010	U3015	48218	IIS057	U4015	48242	IIS140	U2033	48150	IIS219	U6027	48151
8944045450	U1013	48093	IIS058	U4011	48208	IIS141	U1035	48156	IIS220	U4010	48183
9813600070	U1056	48236	IIS059	U5028	48102	IIS142	U2011	48038	IIS221	U2041	48185
9825112400	U1056	48236	IIS060	U6020	48114	IIS143	U1032	48143	IIS222	U3017	48233
9825115350	U1079	48342	IIS061	U5038	48144	IIS144					

KERR NELSON	NGK → STOCK No.	KERR NELSON	NGK → STOCK No.	LEMARK	NGK → STOCK No.	LEMARK	NGK → STOCK No.
IIS223	U6018 48077	IIS324	U2057 48260	CP001	U5001 48002	CP131	U2066 48315
IIS224	U2047 48202	IIS325	U2058 48261	CP002	U2001 48001	CP134	U2055 48254
IIS225	U2037 48167	IIS329	U4017 48264	CP003	U5002 48003	CP135	U2056 48255
IIS226	U5053 48194	IIS330	U5121 48265	CP004	U1001 48000	CP138	U2023 48086
IIS227	U1054 48217	IIS331	U5081 48266	CP005	U6005 48016	CP140	U5076 48257
IIS228	U4009 48171	IIS332	U5082 48267	CP006	U2001 48001	CP142	U5077 48258
IIS229	U5039 48147	IIS334	U5083 48268	CP007	U6008 48023	CP143	U5078 48259
IIS230	U1073 48310	IIS336	U5084 48269	CP008	U6002 48006	CP144	U2057 48260
IIS231	U5011 48035	IIS337	U5101 48317	CP010	U6003 48011	CP145	U2058 48261
IIS232	U5046 48165	IIS339	U4019 48270	CP011	U2003 48010	CP148	U4017 48264
IIS234	U5052 48184	IIS342	U2059 48272	CP012	U6036 48007	CP149	U5121 48265
IIS235	U5049 48174	IIS344	U5086 48273	CP013	U5003 48005	CP150	U5081 48266
IIS236	U5043 48162	IIS348	U5088 48275	CP014	U5055 48206	CP151	U5082 48267
IIS237	U5058 48216	IIS349	U5089 48276	CP015	U5006 48015	CP153	U5084 48269
IIS238	U1085 48203	IIS351	U2029 48110	CP016	U5011 48035	CP155	U4019 48270
IIS239	U6032 48219	IIS352	U5102 48319	CP017	U6010 48043	CP157	U6035 48318
IIS240	U2044 48195	IIS353	U5103 48320	CP018	U5005 48009	CP158	U2059 48272
IIS241	U2049 48220	IIS358	U5104 48321	CP019	U4005 48119	CP160	U5086 48273
IIS242	U1086 48204	IIS359	U5105 48322	CP020	U5027 48095	CP163	U5087 48274
IIS243	U3015 48218	IIS360	U5106 48323	CP021	U6007 48022	CP164	U5088 48275
IIS244	U6031 48205	IIS361	U1075 48324	CP022	U6001 48004	CP165	U5089 48276
IIS245	U5181 48562	IIS362	U2068 48325	CP023	U6019 48083	CP166	U2029 48110
IIS247	U4013 48223	IIS415	U5244 49066	CP024	U6009 48032	CP167	U5102 48319
IIS249	U2050 48224	IIS417	U5310 49048	CP025	U6004 48014	CP168	U5103 48320
IIS250	U4014 48225	IIS437	U6053 49076	CP026	U4001 48055	CP170	U5104 48321
IIS251	U5056 48207	IIS511	U5314 49052	CP027	U2004 48012	CP171	U5105 48322
IIS252	U5061 48226	IIS513	U5147 48397	CP028	U2008 48027	CP172	U5106 48323
IIS253	U5065 48235	IIS514	U5315 49053	CP029	U5019 48063	CP173	U1075 48324
IIS254	U2048 48209	IIS519	U5316 49054	CP030	U2012 48044	CP174	U2068 48325
IIS255	U5062 48227	IIS520	U5317 49055	CP031	U2031 48142	CP175	U5066 48237
IIS256	U3016 48228	IIS521	U6054 49077	CP032	U2028 48108	CP176	U4024 48326
IIS258	U5063 48229	IIS523	U5319 49057	CP033	U6021 48124	CP180	U5110 48330
IIS259	U2051 48230	IIS527	U5320 49058	CP034	U5032 48122	CP181	U5111 48331
IIS260	U5064 48231	IIS528	U5322 49061	CP036	U5083 48268	CP182	U5112 48332
IIS261	U2010 48037	IIS531	U5210 49060	CP037	U5015 48042	CP183	U5113 48333
IIS262	U2028 48108	IIS535	U5323 49062	CP038	U6041 48406	CP184	U5114 48334
IIS263	U5091 48279			CP039	U5055 48206	CP186	U5115 48335
IIS264	U5093 48283	KIA - see HYUNDAI/KIA		CP040	U6039 48404	CP189	U3002 48019
IIS265	U3018 48280			CP041	U1010 48069	CP190	U2007 48026
IIS266	U6036 48007	LADA NGK → STOCK No.		CP042	U2073 48368	CP191	U2015 48053
IIS269	U5094 48284	21083705010	U1076 48339	CP045	U2076 48371	CP192	U2032 48145
IIS270	U5096 48286	210137050560	U1079 48342	CP052	U1018 48105	CP193	U1008 48064
IIS271	U2060 48287	2101370500002	U1079 48342	CP054	U5310 49048	CP194	U1030 48137
IIS272	U2062 48289	2101370506000	U1079 48342	CP067	U6053 49076	CP195	U1041 48186
IIS273	U2063 48290	273705	U1076 48339	CP068	U5155 48410	CP196	U5004 48008
IIS274	U6037 48048	LAMBORGHINI NGK → STOCK No.		CP074	U2013 48049	CP197	U3003 48020
IIS275	U4020 48291	16004528	U3001 48013	CP080	U4028 48376	CP198	U5005 48009
IIS276	U2061 48288	LANCIA - see FIAT		CP081	U4031 48379	CP199	U1024 48117
IIS278	U5097 48292			CP095	U5316 49054	CP200	U1021 48112
IIS279	U5098 48293	LAND ROVER NGK → STOCK No.		CP096	U5317 49055	CP201	U2009 48030
IIS280	U5024 48088	4526466	U5082 48267	CP097	U6054 49077	CP202	U2005 48021
IIS281	U4021 48294	4744015	U5082 48267	CP098	U5148 48398	CP203	U1084 48357
IIS282	U5099 48295	573038	U1056 48236	CP099	U5319 49057	CP204	U2017 48067
IIS283	U2064 48296	8510047	U1056 48236	CP103	U5320 49058	CP205	U1016 48098
IIS284	U5100 48297	ERR6045	U2006 48025	CP105	U1005 48057	CP206	U3001 48013
IIS287	U5090 48278	ERR6269	U2045 48196	CP106	U1012 48092	CP207	U1025 48121
IIS288	U6034 48282	ERR6566	U2006 48025	CP107	U1007 48062	CP208	U1001 48000
IIS292	U5067 48239	LR002954	U5149 48399	CP108	U1029 48132	CP209	U5012 48036
IIS293	U5068 48240	LR022494	U5005 48009	CP109	U1009 48066	CP210	U2006 48025
IIS294	U5069 48241	NEC000070	U5026 48091	CP110	U1012 48092	CP211	U1036 48158
IIS295	U5072 48245	NEC000070L	U5026 48091	CP111	U5067 48239	CP212	U1002 48029
IIS296	U5073 48247	NEC000110L	U5026 48091	CP112	U5068 48240	CP214	U2020 48079
IIS298	U2052 48249	NEC000120L	U4001 48055	CP113	U5069 48241	CP215	U2046 48197
IIS299	U2053 48250	NEC100730L	U4001 48055	CP114	U4015 48242	CP216	U1023 48115
IIS304	U2054 48251	NEC100800	U1027 48125	CP117	U5072 48245	CP218	U3008 48060
IIS305	U5074 48252	NEC100800L	U1027 48125	CP118	U5073 48247	CP219	U1014 48094
IIS306	U5087 48274	PRC9858	U1079 48342	CP119	U4022 48313	CP220	U1013 48093
IIS307	U1059 48253	RTC3433	U1079 48342	CP121	U5123 48350	CP221	U1038 48180
IIS311	U2055 48254	RTC5628	U1076 48339	CP122	U4023 48314	CP222	U1018 48105
IIS312	U2056 48255	RTC5629	U1079 48342	CP123	U2052 48249	CP223	U1045 48198
IIS315	U2023 48086			CP124	U2053 48250	CP224	U1004 48054
IIS317	U5076 48257			CP128	U2054 48251	CP225	U1015 48097
IIS321	U5077 48258			CP129	U5074 48252	CP226	U1033 48148
IIS323	U5078 48259			CP130	U1059 48253	CP227	U1039 48181

LEMARK	NGK → STOCK No.	
CP228	U1040	48182
CP229	U1050	48211
CP231	U2016	48056
CP232	U3005	48028
CP235	U1034	48152
CP236	U1044	48191
CP237	U1047	48200
CP238	U2014	48052
CP239	U3009	48068
CP240	U3007	48058
CP242	U1037	48176
CP243	U2030	48133
CP244	U2025	48096
CP245	U2027	48106
CP246	U4003	48103
CP247	U4007	48149
CP248	U1043	48188
CP249	U2011	48038
CP250	U5028	48102
CP251	U5035	48136
CP252	U6012	48051
CP253	U6011	48045
CP254	U5022	48082
CP255	U2018	48070
CP256	U4026	48018
CP257	U5010	48034
CP258	U6020	48114
CP259	U5018	48061
CP260	U1028	48129
CP261	U5047	48168
CP262	U5016	48046
CP263	U4004	48104
CP264	U5038	48144
CP265	U2021	48080
CP266	U6012	48051
CP267	U3010	48085
CP268	U3006	48050
CP269	U2033	48150
CP270	U5021	48073
CP271	U6014	48072
CP272	U1020	48111
CP273	U6028	48159
CP274	U6006	48017
CP275	U1027	48125
CP276	U2019	48078
CP277	U6016	48075
CP278	U5008	48031
CP279	U6017	48076
CP280	U3004	48024
CP281	U5040	48154
CP282	U5044	48163
CP283	U5031	48120
CP284	U5026	48091
CP285	U6033	48234
CP286	U5041	48155
CP287	U1031	48141
CP288	U6026	48146
CP289	U5048	48172
CP290	U5045	48164
CP291	U6055	49086
CP292	U5020	48065
CP293	U5046	48165
CP294	U5013	48040
CP295	U2034	48153
CP296	U6013	48071
CP297	U6018	48077
CP298	U6015	48074
CP299	U6022	48126
CP300	U5036	48139
CP301	U5033	48127
CP302	U6025	48135
CP303	U5050	48177
CP304	U6030	48192
CP305	U6029	48178

LEMARK	NGK → STOCK No.	
CP306	U2043	48193
CP307	U2036	48166
CP308	U5054	48201
CP309	U4010	48183
CP310	U4006	48134
CP311	U2042	48189
CP312	U2035	48160
CP313	U2040	48173
CP314	U2039	48170
CP315	U5034	48131
CP316	U5037	48140
CP317	U5030	48116
CP318	U5025	48089
CP319	U5014	48041
CP320	U4002	48100
CP322	U5052	48184
CP324	U2047	48202
CP325	U5042	48161
CP326	U5017	48047
CP327	U6027	48151
CP328	U5043	48162
CP329	U5058	48216
CP330	U1054	48217
CP331	U3015	48218
CP332	U2041	48185
CP333	U1085	48203
CP334	U5053	48194
CP335	U6032	48219
CP336	U2044	48195
CP337	U2049	48220
CP338	U1086	48204
CP339	U5049	48174
CP340	U2045	48196
CP341	U6031	48205
CP342	U4009	48171
CP343	U5039	48147
CP344	U5244	49066
CP345	U5090	48278
CP346	U2010	48037
CP347	U5181	48562
CP350	U5051	48179
CP351	U4013	48223
CP352	U5056	48207
CP353	U4008	48157
CP354	U5091	48279
CP355	U3018	48280
CP356	U2050	48224
CP357	U4011	48208
CP358	U4014	48225
CP359	U5029	48107
CP360	U5061	48226
CP361	U5065	48235
CP362	U2048	48209
CP363	U5062	48227
CP364	U3016	48228
CP366	U5063	48229
CP367	U2051	48230
CP368	U5064	48231
CP369	U4012	48210
CP370	U5092	48281
CP371	U2028	48108
CP372	U6034	48282
CP373	U5093	48283
CP375	U5094	48284
CP376	U5095	48285
CP377	U5096	48286
CP378	U2060	48287
CP379	U2061	48288
CP380	U2062	48289
CP381	U2063	48290
CP382	U5117	48337
CP383	U5118	48338
CP384	U4020	48291
CP386	U5097	48292

LEMARK	NGK → STOCK No.	
CP387	U5098	48293
CP388	U5024	48088
CP389	U4021	48294
CP390	U5099	48295
CP391	U2064	48296
CP392	U5100	48297
CP393	U1032	48143
CP394	U1003	48039
CP395	U1035	48156
CP396	U2024	48087
CP397	U2026	48101
CP398	U6037	48048
CP400	U6023	48128
CP403	U5130	49072
CP408	U5210	49060
CP409	U5322	49061
CP412	U5323	49062

LEXUS - see TOYOTA

LUCAS	NGK → STOCK No.	
45058	U1079	48342
45065	U1062	48299
45212	U1079	48342
45213	U1079	48342
45226	U1056	48236
45289	U1079	48342
45290	U1056	48236
36501008	U1056	48236
42533D	U5045	48164
BFU21949604	U1068	48305
CL1	U1079	48342
CL101	U1079	48342
CL102	U1056	48236
CL2	U1079	48342
CL20	U1063	48300
CL201	U1079	48342
CL21	U1079	48342
CL23	U1062	48299
CL25	U1079	48342
CL31	U1079	48342
CL4	U1056	48236
CL5	U1079	48342
CL61	U1079	48342
CL62	U1079	48342
CL63	U1079	48342
CL71	U1056	48236
CL72	U1056	48236
CL73	U1056	48236
DAB427	U1001	48000
DAB430	U1003	48039
DLB100	U1061	48298
DLB101	U1079	48342
DLB102	U1056	48236
DLB103	U1062	48299
DLB109	U1068	48305
DLB120	U1063	48300
DLB170	U1073	48310
DLB198	U1076	48339
DLB199	U1076	48339
DLB205	U1007	48062
DLB206	U1029	48132
DLB222	U3017	48233
DLB231	U1068	48305
DLB232	U1076	48339
DLB233	U1009	48066
DLB237	U1065	48302
DLB238	U1066	48303
DLB241	U1068	48305
DLB242	U1082	48345
DLB243	U1076	48339
DLB246	U1081	48344
DLB247	U1070	48307
DLB248	U1070	48307

LUCAS	NGK → STOCK No.	
DLB301	U1026	48123
DLB303	U1079	48342
DLB306	U1076	48339
DLB310	U1083	48346
DLB313	U1071	48308
DLB314	U3001	48013
DLB332	U1044	48191
DLB400	U1065	48302
DLB401	U1078	48341
DLB402	U1069	48306
DLB403	U1080	48343
DLB404	U1083	48346
DLB405	U1077	48340
DLB406	U1064	48301
DLB407	U1072	48309
DLB700	U1010	48069
DLB704	U1005	48057
DLB705	U1016	48098
DLB706	U1025	48121
DLB707	U1002	48029
DLB800	U1008	48064
DLB801	U1030	48137
DLB802	U1041	48186
DLB803	U3013	48175
DLJ206	U1068	48305
DLJ300	U1024	48117
DLJ313	U1004	48054
DLJ400	U1021	48112
DLJ401	U1022	48113
DLJ402	U1036	48158
DLJ431	U1013	48093
DLJ454	U1043	48188
DMB976	U5244	49066
DMB1001	U1025	48121
DMB1003	U1071	48308
DMB1006	U2003	48010
DMB1007	U4012	48210
DMB1008	U5017	48047
DMB1010	U4014	48225
DMB1013	U4020	48291
DMB1014	U2010	48037
DMB1015	U2005	48021
DMB1017	U5092	48281
DMB1019	U6053	49076
DMB1021	U5024	48088
DMB1022	U5054	48201
DMB1023	U2048	48209
DMB1024	U2054	48251
DMB1025	U2064	48296
DMB1026	U4021	48294
DMB1027	U2060	48287
DMB1028	U2063	48290
DMB1029	U5005	48206
DMB1030	U2068	48325
DMB1031	U4008	48157
DMB1032	U2029	48110
DMB1035	U5037	48140
DMB1043	U5014	48041
DMB1044	U5017	48047
DMB1047	U2044	48195
DMB1049	U5029	48107
DMB1049	U5029	48107
DMB1054	U1050	48211
DMB1058	U1025	48121
DMB1061	U5089	48276
DMB1062	U5091	48279
DMB1065	U5099	48295
DMB1066	U5097	48292
DMB1067	U5098	48293
DMB1072	U2051	48230
DMB1073	U5067	48239
DMB1074	U5074	48252
DMB1075	U4023	48314
DMB1077	U1085	48203

LUCAS	NGK → STOCK No.	LUCAS	NGK → STOCK No.	LUCAS	NGK → STOCK No.	LUCAS	NGK → STOCK No.
DMB1078	U5053 48194	DMB814	U6010 48043	DMB902	U5027 48095	DMB979	U5181 48562
DMB1080	U1059 48253	DMB815	U6007 48022	DMB903	U2028 48108	DMB981	U6037 48048
DMB1081	U4019 48270	DMB816	U6002 48006	DMB903	U2028 48108	DMB983	U5051 48179
DMB1083	U2045 48196	DMB817	U6003 48011	DMB904	U6033 48234	DMB984	U4013 48223
DMB1084	U5100 48297	DMB818	U5028 48102	DMB905	U5041 48155	DMB985	U5056 48207
DMB1087	U2053 48250	DMB819	U5035 48136	DMB906	U5014 48041	DMB986	U6021 48124
DMB1089	U5056 48207	DMB820	U5022 48082	DMB907	U5006 48015	DMB988	U4008 48157
DMB1090	U5114 48334	DMB821	U4001 48055	DMB908	U5015 48042	DMB989	U5091 48279
DMB1092	U5043 48162	DMB822	U2004 48012	DMB909	U5048 48172	DMB990	U2066 48315
DMB1096	U2047 48202	DMB823	U1012 48092	DMB910	U5011 48035	DMB992	U2052 48249
DMB1097	U4010 48183	DMB824	U2032 48145	DMB911	U2038 48169	DMB993	U1017 48099
DMB1099	U5090 48278	DMB825	U3013 48175	DMB911	U6055 49086	DMB998	U2062 48289
DMB1102	U4009 48171	DMB829	U1084 48357	DMB912	U5020 48065	DMB999	U2061 48288
DMB1103	U5244 49066	DMB830	U1023 48115	DMB913	U5046 48165	ELC0427	U1001 48000
DMB1106	U5086 48273	DMB832	U1038 48180	DMB914	U5013 48040	ELC0804	U5001 48002
DMB1109	U1043 48188	DMB833	U1018 48105	DMB915	U2034 48153	ELC0805	U2001 48001
DMB1112	U5082 48267	DMB834	U1015 48097	DMB916	U6015 48074	ELC0807	U5002 48003
DMB1114	U1071 48308	DMB835	U1039 48181	DMB917	U6013 48071	ELC0808	U5003 48005
DMB1115	U5083 48268	DMB836	U1040 48182	DMB918	U6018 48077	ELC0809	U6036 48007
DMB1116	U3015 48218	DMB841	U1034 48152	DMB919	U5036 48139	ELC0810	U2001 48001
DMB1117	U5087 48274	DMB846	U1037 48176	DMB920	U6022 48126	ELC0812	U6008 48023
DMB1118	U2023 48086	DMB847	U2030 48133	DMB921	U2026 48101	ELC0813	U6005 48016
DMB1119	U5096 48286	DMB848	U2025 48096	DMB922	U2012 48044	ELC0816	U6002 48006
DMB1121	U5112 48332	DMB849	U2027 48106	DMB923	U6025 48135	ELC0817	U6003 48011
DMB1123	U5061 48226	DMB850	U4003 48103	DMB924	U5050 48177	ELC0821	U4001 48055
DMB1124	U5094 48284	DMB851	U4007 48149	DMB925	U5005 48009	HA12	U1079 48342
DMB1125	U5084 48269	DMB852	U2011 48038	DMB926	U2043 48193	LA12	U1061 48298
DMB1127	U5076 48257	DMB853	U6012 48051	DMB927	U5033 48127	LA6	U1062 48299
DMB1139	U5118 48338	DMB854	U6011 48045	DMB928	U2031 48142		
DMB1140	U3018 48280	DMB855	U2018 48070	DMB929	U2042 48189	MAGNETI MARELLI NGK → STOCK No.	
DMB1143	U4024 48326	DMB856	U5032 48122	DMB930	U4010 48183	060705404010	U1025 48121
DMB1146	U1001 48000	DMB857	U4026 48018	DMB931	U2035 48160	060794001010	U2038 48169
DMB1151	U5103 48320	DMB858	U5010 48034	DMB932	U5054 48201	060794001010	U6055 49086
DMB1152	U5102 48319	DMB859	U4005 48119	DMB933	U2036 48166	MASERATI NGK → STOCK No.	
DMB1154	U5093 48283	DMB860	U6020 48114	DMB934	U2040 48173	571084200	U5044 48163
DMB1155	U6039 48404	DMB861	U5018 48061	DMB935	U2039 48170		
DMB1156	U5063 48229	DMB862	U1028 48129	DMB936	U6029 48178	MAZDA NGK → STOCK No.	
DMB1159	U5065 48235	DMB863	U5047 48168	DMB937	U6030 48192	022218100B	U1056 48236
DMB200	U2009 48030	DMB864	U5016 48046	DMB938	U4006 48134	027518100	U1056 48236
DMB201	U2017 48067	DMB865	U4004 48104	DMB939	U6001 48004	055418100	U1056 48236
DMB202	U1006 48059	DMB866	U6009 48032	DMB940	U5034 48131	152418100A	U1056 48236
DMB2057	U6054 49077	DMB867	U2021 48080	DMB941	U5037 48140	1E031810X	U2001 48001
DMB2062	U5319 49057	DMB868	U6004 48014	DMB942	U1033 48148	1E041810X	U2001 48001
DMB2072	U5317 49055	DMB869	U6012 48051	DMB943	U1047 48200	1E0518100	U2005 48021
DMB2077	U5315 49053	DMB870	U3010 48085	DMB944	U5030 48116	1E0518100A	U2005 48021
DMB2078	U5314 49052	DMB871	U6023 48128	DMB945	U5025 48089	1E0518100B	U2001 48001
DMB2079	U5316 49054	DMB872	U3006 48050	DMB946	U5014 48041	1F2018100	U2001 48001
DMB2090	U5320 49058	DMB873	U2033 48150	DMB947	U4002 48100	29018100	U1079 48342
DMB300	U2006 48025	DMB874	U5021 48073	DMB949	U1014 48094	71018100	U1079 48342
DMB400	U5012 48036	DMB875	U6014 48072	DMB952	U2047 48202	AJ0318100	U5089 48276
DMB403	U5004 48008	DMB876	U1020 48111	DMB954	U5052 48184	AJ0318100A	U5089 48276
DMB404	U3009 48068	DMB877	U5009 48033	DMB955	U5049 48174	AJ0918100	U5089 48276
DMB405	U3007 48058	DMB877	U5055 48206	DMB956	U2037 48167	AJ0918100A	U5089 48276
DMB406	U2019 48078	DMB878	U6028 48159	DMB957	U5017 48047	AJC118100	U5089 48276
DMB407	U3002 48019	DMB879	U6006 48017	DMB958	U5042 48161	B1211810X	U1033 48148
DMB408	U2007 48026	DMB880	U6019 48083	DMB959	U6027 48151	B5411810XA	U1033 48148
DMB409	U3003 48020	DMB882	U1027 48125	DMB960	U5043 48162	B5421810XA	U1033 48148
DMB410	U2015 48053	DMB883	U2019 48078	DMB961	U5058 48216	B61P1810XC	U2053 48250
DMB411	U5045 48164	DMB884	U6016 48075	DMB962	U2041 48185	B61P1810XD	U2053 48250
DMB751	U2005 48021	DMB885	U5008 48031	DMB963	U1085 48203	B6S71810XA	U1036 48158
DMB752	U2020 48079	DMB886	U6017 48076	DMB964	U5053 48194	B6S81810XA	U1036 48158
DMB800	U2016 48056	DMB887	U3004 48024	DMB965	U6032 48219	BP6D18100A	U4013 48223
DMB801	U3008 48060	DMB888	U5040 48154	DMB966	U2044 48195	BP6D18100A9U	U4013 48223
DMB802	U3005 48028	DMB889	U5044 48163	DMB967	U2049 48220	BPE81810XA	U2050 48224
DMB804	U5001 48002	DMB890	U1032 48143	DMB968	U1086 48204	BPE81810XB	U2037 48167
DMB805	U2001 48001	DMB891	U2003 48010	DMB969	U1054 48217	BPE81810XC	U2037 48167
DMB806	U5038 48144	DMB892	U1035 48156	DMB970	U3015 48218	BPE81810XC9U	U2037 48167
DMB807	U5002 48003	DMB893	U5031 48120	DMB972	U6031 48205	C40118100A	U2008 48027
DMB808	U5003 48005	DMB894	U1031 48141	DMB973	U5055 48206	E30118100	U1068 48305
DMB809	U6036 48007	DMB895	U2024 48087	DMB974	U4009 48171	E30118100A	U1068 48305
DMB810	U2001 48001	DMB896	U6026 48146	DMB975	U5039 48147	E80118100B	U1068 48305
DMB811	U2014 48052	DMB897	U2008 48027	DMB977	U5090 48278	F21018100	U1021 48112
DMB812	U6008 48023	DMB899	U5019 48063	DMB978	U2010 48037	F21018100B	U1021 48112
DMB813	U6005 48016	DMB901	U5026 48091	DMB979	U5059 48221		

MAZDA	NGK → STOCK No.		MEAT & DORIA	NGK → STOCK No.		MEAT & DORIA	NGK → STOCK No.		MERCEDES BENZ	NGK → STOCK No.	
F21118100A	U1021	48112	10334	U5028	48102	10554	U5059	48221	1587203	U5114	48334
F80118100B	U1068	48305	10336	U2007	48026	10554	U5181	48562	158720364	U5114	48334
FFY118100	U4011	48208	10338	U4003	48103	10555	U5037	48140	1587303	U3004	48024
FP8518100B	U4011	48208	10341	U5025	48089	10558	U5065	48235	1587803	U3004	48024
FP8518100C	U4011	48208	10342	U5004	48008	10560	U5068	48240	1601587703	U3010	48085
FPY118100	U4011	48208	10345	U3002	48019	10561	U5084	48269	2729060060	U5117	48337
FSD718100	U2005	48021	10347	U3003	48020	10563	U5099	48295	A0001500280	U4026	48018
G60118100	U1033	48148	10351	U5009	48033	10564	U5058	48216	A0001500480	U3006	48050
G6011810X	U1033	48148	10351	U5055	48206	10567	U1086	48204	A0001501380	U6006	48017
G60218100	U1033	48148	10353	U5005	48009	10568	U5053	48194	A0001501580	U5034	48131
G6021810X	U1033	48148	10354	U3008	48060	10570	U2023	48086	A0001501780	U5025	48089
G60718100	U1033	48148	10355	U5005	48009	10579	U5077	48258	A0001501980	U5117	48337
G6071810X	U1033	48148	10357	U5027	48095	10582	U5072	48245	A0001502580	U5056	48207
G62218100	U1033	48148	10361	U1037	48176	10586	U2059	48272	A0001502680	U5117	48337
G6221810X	U1033	48148	10362	U3004	48024	10600	U5117	48337	A0001502780	U5117	48337
G62318100	U1033	48148	10364	U2024	48087	10601	U5073	48247	A0001502880	U5025	48089
G6231810X	U1033	48148	10367	U3009	48068	10604	U6041	48406	A0001502980	U5034	48131
GY0718100	U2023	48086	10368	U2039	48170	10605	U4009	48171	A0001584503	U1023	48115
JE4818100B	U1033	48148	10371	U5015	48042	10608	U5063	48229	A0001586503	U1074	48311
JE481810XB	U1033	48148	10377	U2021	48080	10609	U5083	48268	A0001586803	U3006	48050
JE4918100B	U1033	48148	10379	U2019	48078	10611	U2053	48250	A0001587003	U4026	48018
JE491810XB	U1033	48148	10382	U2030	48133	10613	U5115	48335	A0001587103	U4026	48018
JF0118100B	U1021	48112	10391	U6009	48032	10617	U5076	48257	A0001587303	U3004	48024
KF0118100	U1033	48148	10394	U6033	48234	10618	U5087	48274	A0001587503	U4026	48018
KF011810X	U1033	48148	10395	U2038	48169	10624	U5105	48322	A0001587703	U3010	48085
KL6418100	U2029	48110	10395	U6055	49086	10647	U5093	48283	A0001587803	U3004	48024
KL6418100A	U2029	48110	10401	U4006	48134	10648	U5082	48267	A0002729060060	U5117	48337
L3G218100A	U5063	48229	10403	U2076	48371	10650	U5121	48265	A0031585001	U2024	48087
L3G218100A9U	U5063	48229	10404	U2052	48249	10653	U2055	48254	A1601587703	U3010	48085
L3G218100B	U5063	48229	10405	U6004	48014	10654	U2056	48255			
L80718100Z04	U5050	48177	10406	U5032	48122	10655	U5078	48259	METZGER	NGK → STOCK No.	
L81318100	U2074	48369	10409	U2041	48185	10656	U2057	48260	0880118	U4014	48225
LF0118100	U2001	48001	10412	U4014	48225	10666	U4011	48208			
LF1618100	U5019	48063	10413	U5030	48116	10674	U4015	48242	MINI - see BMW		
LF1618100A	U5019	48063	10414	U4008	48157	10676	U5031	48120			
LF1618100B	U5019	48063	10416	U5021	48073	10678	U5062	48227	MITSUBISHI	NGK → STOCK No.	
N3H118100	U5093	48283	10420	U2028	48108	10680	U3013	48175	017612	U1079	48342
N3H1181009U	U5093	48283	10439	U4001	48055	10682	U3018	48280	1832A010	U4031	48379
N3H118100A	U5093	48283	10444	U5029	48107	10688	U5148	48398	1832A042	U5210	49060
N3H118100A9U	U5093	48283	10446	U4021	48294	10695	U1075	48324	H3T024	U1011	48090
N3H118100B	U5093	48283	10449	U2061	48288	10696	U5089	48276	H6T11471	U5210	49060
N3H118100B9U	U5093	48283	10453	U2048	48209	10713	U5155	48410	H6T15371ZC	U5315	49053
OK2011810XB	U1011	48090	10456	U5034	48131	10717	U5147	48397	H6T60271	U5244	49066
YF091810X	U2001	48001	10460	U5006	48015	10729	U5104	48321	H006T11471	U5210	49060
ZL0118100	U4015	48242	10461	U5041	48155	10730	U6034	48282	M04557468	U2044	48195
ZL0118100A	U4015	48242	10462	U2008	48027	10744	U4007	48149	MD001800	U1079	48342
ZL0118100B	U4015	48242	10463	U6019	48083				MD001804	U1079	48342
ZZL018100	U2029	48110	10464	U6021	48124	MERCEDES BENZ	NGK → STOCK No.		MD003823	U1056	48236
ZZM018100	U2005	48021	10468	U6016	48075	0001500280	U4026	48018	MD013780	U1068	48305
ZZM718100	U2029	48110	10470	U6017	48076	0001500480	U3006	48050	MD080624	U1068	48305
			10471	U6015	48074	0001501380	U6006	48017	MD104696	U1034	48152
MEAT & DORIA	NGK → STOCK No.		10472	U6013	48071	0001501580	U5034	48131	MD111950	U1022	48113
10300	U5001	48002	10478	U5002	48003	0001501780	U5025	48089	MD113551	U1084	48357
10302	U3001	48013	10480	U6001	48004	0001501980	U5117	48337	MD114994	U1022	48113
10303	U2014	48052	10482	U5033	48127	0001502580	U5056	48207	MD120167	U1022	48113
10307	U2003	48010	10483	U6022	48126	0001502680	U5117	48337	MD126461	U2042	48189
10308	U1001	48000	10485	U5020	48065	0001502780	U5117	48337	MD131711	U1084	48357
10314	U2005	48021	10487	U5036	48139	0001502880	U5025	48089	MD158409	U3020	48374
10315	U6002	48006	10491	U2066	48315	0001502980	U5034	48131	MD163599	U3020	48374
10316	U2004	48012	10493	U2031	48142	0001584003	U1076	48339	MD179787	U3020	48374
10318	U2001	48001	10497	U5013	48040	0001586103	U1023	48115	MD184230	U3020	48374
10318	U2001	48001	10500	U5043	48162	0001586503	U1074	48311	MD192126	U3020	48374
10320	U4004	48104	10503	U5046	48165	0001586803	U3006	48050	MD310298	U3020	48374
10321	U4026	48018	10504	U5024	48088	0001587003	U4026	48018	MD314583	U3016	48228
10322	U2018	48070	10512	U4010	48183	0001587103	U4026	48018	MD321461	U4028	48376
10323	U6008	48023	10514	U5054	48201	0001587203	U5114	48334	MD325048	U4014	48225
10324	U6005	48016	10516	U5113	48333	0001587303	U3004	48024	MD360384	U4014	48225
10325	U6036	48007	10517	U5111	48331	0001587503	U4026	48018	MD361710	U4027	48375
10326	U6007	48022	10528	U5039	48147	0001587703	U3010	48085	MD362903	U4027	48375
10327	U6010	48043	10530	U5055	48206	0001587803	U3004	48024	MD362907	U4014	48225
10328	U5003	48005	10532	U1018	48105	0031585001	U2024	48087	MD362913	U4012	48210
10330	U5022	48082	10532	U1045	48198	1500480	U3006	48050	MD363552	U4028	48376
10331	U5010	48034	10540	U1018	48105	1501380	U6006	48017	MD366821	U4012	48210
10332	U5018	48061	10548	U5049	48174	1586803	U3006	48050	MD52696760	U2041	48185

mitsubishi	NGK → STOCK No.	
MN195616	U5101	48317
M05269670	U2041	48185
MR994643	U5148	48398
MOBILTRON	NGK → STOCK No.	
CC-01	U3020	48374
CC-03	U1022	48113
CC-05	U1022	48113
CC-06	U1084	48357
CC-07	U1059	48253
CC-09	U1086	48204
CC-11	U1034	48152
CC-13	U1085	48203
CC-21	U2044	48195
CC-22	U2041	48185
CC-23	U4014	48225
CC-29	U2058	48261
CC-30	U4017	48264
CC-31	U5053	48194
CC-33	U5049	48174
CC-35	U5121	48265
CC-36	U5105	48322
CC-37	U5104	48321
CE-01	U1001	48000
CE-02	U1002	48029
CE-03	U1005	48057
CE-04	U1007	48062
CE-06	U1008	48064
CE-07	U1025	48121
CE-08	U3001	48013
CE-09	U1001	48000
CE-17	U1009	48066
CE-19	U1047	48200
CE-20	U1029	48132
CE-21	U1012	48092
CE-23	U2003	48010
CE-24	U2009	48030
CE-25	U6002	48006
CE-26	U6008	48023
CE-27	U6005	48016
CE-28	U5001	48002
CE-29	U3002	48019
CE-30	U3003	48020
CE-31	U1026	48123
CE-33	U3008	48060
CE-34	U3009	48068
CE-37	U2006	48025
CE-38	U2007	48026
CE-39	U2016	48056
CE-42	U6036	48007
CE-43	U2024	48087
CE-44	U2014	48052
CE-45	U5003	48005
CE-47	U3006	48050
CE-50	U5055	48206
CE-51	U5002	48003
CE-52	U5020	48065
CE-53	U1023	48115
CE-54	U3005	48028
CE-55	U6003	48011
CE-56	U5004	48008
CE-57	U4026	48018
CE-58	U1074	48311
CE-59	U2032	48145
CE-60	U2025	48096
CE-61	U3007	48058
CE-62	U1006	48059
CE-63	U2015	48053
CE-64	U2011	48038
CE-65	U2017	48067
CE-66	U6011	48045
CE-67	U6004	48014
CE-68	U6007	48022
CE-69	U6006	48017

MOBILTRON	NGK → STOCK No.	
CE-70	U6010	48043
CE-71	U5010	48034
CE-72	U5018	48061
CE-73	U2019	48078
CE-74	U2028	48108
CE-76	U2027	48106
CE-77	U5008	48031
CE-78	U6009	48032
CE-79	U6019	48083
CE-80	U6012	48051
CE-81	U6001	48004
CE-86	U3004	48024
CE-87	U2013	48049
CE-88	U5055	48206
CE-89	U5005	48009
CE-90	U5012	48036
CE-91	U5025	48089
CE-93	U5013	48040
CE-94	U3010	48085
CE-96	U5047	48168
CE-98	U5016	48046
CE-99	U1074	48311
CE-102	U5022	48082
CE-103	U4003	48103
CE-104	U4004	48104
CE-105	U6013	48071
CE-106	U6014	48072
CE-107	U5026	48091
CE-108	U6021	48124
CE-109	U2026	48101
CE-112	U4007	48149
CE-113	U6020	48114
CE-114	U6033	48234
CE-117	U5021	48073
CE-118	U6022	48126
CE-119	U6016	48075
CE-120	U1027	48125
CE-122	U5001	48002
CE-124	U5114	48334
CE-125	U5005	48009
CE-126	U5011	48035
CE-127	U4009	48171
CE-128	U5066	48237
CE-129	U5033	48127
CE-130	U5037	48140
CE-131	U6040	48405
CE-132	U6023	48128
CE-134	U6030	48192
CE-135	U6029	48178
CE-137	U5028	48102
CE-140	U2045	48196
CE-141	U2021	48080
CE-143	U5015	48042
CE-146	U2006	48025
CE-147	U2028	48108
CE-148	U5024	48088
CE-149	U5006	48015
CE-150	U5069	48241
CE-151	U5014	48041
CE-152	U6055	49086
CE-155	U5055	48206
CE-156	U6025	48135
CE-157	U2030	48133
CE-158	U6028	48159
CE-159	U5035	48136
CE-160	U5039	48147
CE-162	U6027	48151
CF-02	U2005	48021
CF-04	U1036	48158
CF-06	U1033	48148
CF-09	U1021	48112
CF-10	U1024	48117
CF-11	U1011	48090
CF-44	U2029	48110

MOBILTRON	NGK → STOCK No.	
CF-45	U2020	48079
CF-46	U2001	48001
CF-49	U1028	48129
CF-50	U5031	48120
CF-51	U5089	48276
CF-55	U4015	48242
CF-56	U2023	48086
CF-57	U4011	48208
CF-59	U2074	48369
CF-60	U5019	48063
CF-62	U2008	48027
CF-65	U4005	48119
CF-69	U2001	48001
CF-70	U5093	48283
CF-71	U5063	48229
CF-72	U5083	48268
CG-04	U1054	48217
CG-05	U3015	48218
CG-10	U1028	48129
CG-12	U1040	48182
CG-16	U2004	48012
CG-20	U2018	48070
CG-21	U2018	48070
CG-24	U2031	48142
CG-25	U1031	48141
CH-01	U1016	48098
CH-02	U1017	48099
CH-03	U1004	48054
CH-04	U1015	48097
CH-05	U1020	48111
CH-06	U1050	48211
CH-11	U1039	48181
CH-23	U5051	48179
CH-25	U5099	48295
CH-26	U5098	48293
CH-27	U5097	48292
CH-28	U5051	48179
CH-29	U5081	48266
CJ-01	U4010	48183
CJ-05	U4008	48157
CJ-07	U5062	48227
CJ-08	U5077	48258
CJ-09	U2056	48255
CJ-12	U2055	48254
CK-03	U1037	48176
CK-04	U2039	48170
CK-05	U2048	48209
CK-06	U2076	48371
CK-07	U4021	48294
CK-08	U4020	48291
CK-10	U2051	48230
CK-12	U2062	48289
CK-14	U4023	48314
CK-16	U2052	48249
CK-17	U2060	48287
CK-18	U2036	48166
CK-19	U2061	48288
CK-20	U2040	48173
CK-21	U2035	48160
CK-24	U4006	48134
CK-25	U5073	48247
CK-26	U2075	48370
CK-28	U6035	48318
CK-29	U2054	48251
CK-30	U2064	48296
CK-32	U5067	48239
CK-33	U5072	48245
CM-08	U4012	48210
CM-11	U3016	48228
CN-14	U5036	48139
CN-16	U5061	48226
CN-19	U5032	48122
CN-20	U5113	48333
CN-21	U5110	48330

MOBILTRON	NGK → STOCK No.	
CN-22	U5111	48331
CN-31	U5112	48332
CN-35	U5043	48162
CN-38	U5119	48347
CR-01	U4001	48055
CR-02	U4002	48100
CT-05	U1018	48105
CT-06	U1091	48363
CT-07	U1013	48093
CT-08	U1014	48094
CT-10	U4024	48326
CT-12	U1043	48188
CT-24	U5027	48095
CT-25	U5029	48107
CT-28	U5030	48116
CT-29	U5100	48297
CT-30	U3018	48280
CT-36	U5065	48235
CT-37	U5052	48184
CT-38	U5090	48278
CT-40	U5076	48257
CT-41	U5068	48240
CT-44	U5086	48273
CT-45	U5084	48269
CT-47	U5145	48395
CU-01	U5092	48281
CU-02	U5095	48285
CU-03	U2047	48202

NISSAN	NGK → STOCK No.	
2243314600	U1056	48236
2243314605	U1056	48236
2243314606	U1056	48236
2243314615	U1056	48236
2243314616	U1056	48236
2243314800	U1079	48342
2243314805	U1079	48342
2243314806	U1079	48342
2243314810	U1079	48342
2243314811	U1079	48342
2243314815	U1079	48342
2243314816	U1079	48342
2243314900	U1079	48342
2243314905	U1079	48342
2243328510	U1056	48236
2243328511	U1056	48236
2243331300	U1079	48342
2243331303	U1079	48342
2243358000	U1079	48342
2243378500	U1079	48342
2243378510	U1079	48342
2243379011	U1079	48342
2243379012	U1079	48342
2243301E10	U1070	48307
2243309E10	U1070	48307
2244800QAF	U6052	49075
2246201E10	U1070	48307
2243303A10	U1070	48307
224330B000	U1024	48117
2243351J10	U1024	48117
2243353A10	U1070	48307
2243353J20	U1024	48117
2243355S10	U1024	48117
2243356E11	U1024	48117
224338J115	U5112	48332
22433A5210	U1056	48236
22433A5400	U1056	48236
22433A5410	U1056	48236
22433C7910	U1056	48236
22433E5210	U1056	48236
22433S3100	U1056	48236
22433U3140	U1056	48236
2244800QAA	U5001	48002
2244800QAC	U5001	48002

SMPE - see INTERMOTOR		
SOVEREIGN	NGK → STOCK No.	
SC002	U6002	48006
SC003	U6007	48022
SC004	U6003	48011
SC005	U5027	48095
SC006	U5036	48139
SC009	U4008	48157
SC012	U5022	48082
SC017	U5004	48008
SC021A	U5001	48002
SC022	U6010	48043
SC028	U6008	48023
SC029	U6005	48016
SC030A	U5003	48005
SC034	U5033	48127
SC0420E	U5002	48003
SC047	U4001	48055
SC049	U6020	48114
SC051	U6004	48014
SC055	U5055	48206
SC061	U6023	48128
SC079	U6001	48004
SCL01	U6036	48007
SCP714A	U2001	48001
SUBARU	NGK → STOCK No.	
22433-AA240	U2047	48202
22433-AA370	U2047	48202
22433-AA400	U2056	48255
22433-AA410	U2055	48254
22433-AA418	U5319	49057
22433-AA41A	U2055	48254
22433-AA41B	U2055	48254
22433-AA451	U5062	48227
22433-AA480	U5319	49057
22433-AA540	U5319	49057
22433-AA570	U2055	48254
22433-AA640	U5319	49057
32055-2800	U1056	48236
32988-2800	U1056	48236
42988-7153	U1056	48236
42988-7163	U1056	48236
42988-7400	U1056	48236
42988-7500	U1056	48236
82988-4110	U1079	48342
82988-4112	U1079	48342
82988-6102	U1056	48236
82988-6111	U1079	48342
SUZUKI	NGK → STOCK No.	
33400-51K10	U5309	49047
33400-65G00	U4008	48157
33400-65G01	U4008	48157
33400-65G02	U4008	48157
33400-78J02	U5130	49072
33410-56B10	U1040	48182
33410-57B10	U1038	48180
33410-57B10-000	U1038	48180
33410-66D00	U4010	48183
33410-66D01	U4010	48183
33410-77E10	U5095	48285
33410-77E11	U5095	48285
33410-77E20	U5092	48281
33410-77E21	U5092	48281
33410-77E22	U5092	48281
33410-80C10	U1038	48180
33410-80C1000	U1038	48180
TESLA	NGK → STOCK No.	
CL001	U1001	48000
CL002	U2003	48010
CL005	U5003	48005
CL006	U2010	48037

TESLA	NGK → STOCK No.	
CL007	U6020	48114
CL008	U6033	48234
CL009	U5006	48015
CL010	U2011	48038
CL014	U5022	48082
CL015	U5014	48041
CL016	U5020	48065
CL019	U1003	48039
CL021	U2024	48087
CL022	U5017	48047
CL023	U5011	48035
CL024	U5046	48165
CL026	U2013	48049
CL028	U6037	48048
CL100	U5001	48002
CL104	U6004	48014
CL105	U5044	48163
CL106	U2017	48067
CL108	U1007	48062
CL109	U1009	48066
CL110	U6008	48023
CL111	U6005	48016
CL112	U6009	48032
CL114	U1029	48132
CL116	U2007	48026
CL118	U1012	48092
CL119	U1035	48156
CL120	U6015	48074
CL121	U5033	48127
CL127	U6011	48045
CL130	U6036	48007
CL131	U2019	48078
CL132	U5021	48073
CL133	U6014	48072
CL135	U5008	48031
CL138	U6013	48071
CL139	U6018	48077
CL140	U6016	48075
CL141	U6017	48076
CL150	U2028	48108
CL151	U6021	48124
CL200	U2004	48012
CL201	U2018	48070
CL205	U1002	48029
CL209	U2025	48096
CL210	U2043	48193
CL211	U1031	48141
CL212	U2021	48080
CL213	U6007	48022
CL216	U2034	48153
CL217	U6022	48126
CL218	U6025	48135
CL220	U2031	48142
CL221	U6001	48004
CL222	U2027	48106
CL223	U6028	48159
CL224	U6026	48146
CL225	U2062	48289
CL226	U6027	48151
CL229	U6029	48178
CL230	U6030	48192
CL302	U2006	48025
CL304	U1008	48064
CL306	U4003	48103
CL307	U4004	48104
CL309	U2038	48169
CL309	U6055	49086
CL313	U1025	48121
CL314	U5028	48102
CL315	U5035	48136
CL316	U3013	48175
CL317	U5047	48168
CL320	U5040	48154
CL321	U5042	48161

TESLA	NGK → STOCK No.	
CL323	U5096	48286
CL403	U2008	48027
CL404	U4005	48119
CL405	U5019	48063
CL406	U2012	48044
CL407	U5050	48177
CL408	U2020	48079
CL409	U2001	48001
CL410	U5037	48140
CL500	U1016	48098
CL501	U1004	48054
CL502	U2040	48173
CL503	U2035	48160
CL505	U4021	48294
CL506	U1036	48158
CL507	U1033	48148
CL508	U1022	48113
CL509	U1024	48117
CL511	U5036	48139
CL512	U5095	48285
CL513	U1013	48093
CL515	U4006	48134
CL520	U5027	48095
CL521	U5041	48155
CL522	U5085	48271
CL524	U2048	48209
CL525	U1034	48152
CL526	U2042	48189
CL527	U2052	48249
CL529	U2064	48296
CL530	U2061	48288
CL531	U2054	48251
CL532	U2067	48316
CL533	U4010	48183
CL534	U5054	48201
CL537	U5111	48331
CL537	U5111	48331
CL537	U5113	48333
CL538	U5113	48333
CL539	U2036	48166
CL541	U2063	48290
CL542	U5030	48116
CL543	U1084	48357
CL546	U2060	48287
CL547	U4014	48225
CL548	U4020	48291
CL549	U4012	48210
CL550	U5051	48179
CL553	U4022	48313
CL553	U4023	48314
CL554	U5043	48162
CL555	U5029	48107
CL556	U5099	48295
CL559	U1021	48112
CL560	U1017	48099
CL561	U4008	48157
CL566	U5072	48245
CL568	U1014	48094
CL569	U1020	48111
CL570	U2047	48202
CL571	U5100	48297
CL600	U5005	48009
CL601	U5012	48036
CL602	U5009	48033
CL602	U5055	48206
CL603	U5055	48206
CL605	U3004	48024
CL606	U4026	48018
CL607	U3010	48085
CL609	U1023	48115
CL610	U6006	48017
CL611	U3006	48050
CL613	U1074	48311
CL615	U2030	48133
CL616	U5025	48089

TESLA	NGK → STOCK No.	
CL617	U5114	48334
CL618	U5034	48131
CL702	U5026	48091
CL706	U2041	48185
CL707	U4009	48171
CL800	U5023	48084
CL802	U2065	48312
TOYOTA	NGK → STOCK No.	
19070-74170	U1043	48188
19500-74040	U1018	48105
19500-74050	U1045	48198
19500-74090	U1043	48188
19500-74091	U1043	48188
19500-74100	U1043	48188
90080-19008	U3018	48280
90080-19012	U4024	48326
90080-19015	U5029	48107
90080-19016	U5100	48297
90080-19017	U5030	48116
90080-19019	U5029	48107
90080-19021	U5027	48095
90919-02004	U1079	48342
90919-02006	U1056	48236
90919-02007	U1079	48342
90919-02008	U1079	48342
90919-02013	U1079	48342
90919-02014	U1079	48342
90919-02015	U1079	48342
90919-02016	U1079	48342
90919-02017	U1079	48342
90919-02019	U1079	48342
90919-02020	U1079	48342
90919-02026	U1079	48342
90919-02027	U1079	48342
90919-02030	U1079	48342
90919-02031	U1079	48342
90919-02042	U1056	48236
90919-02043	U1079	48342
90919-02058	U1079	48342
90919-02102	U1068	48305
90919-02111	U1056	48236
90919-02137	U1068	48305
90919-02163	U1014	48094
90919-02164	U1013	48093
90919-02185	U1091	48363
90919-02197	U1018	48105
90919-02208	U1018	48105
90919-02209	U1043	48188
90919-02215	U4024	48326
90919-02217	U3018	48280
90919-02218	U3018	48280
90919-02220	U3018	48280
90919-02230	U5065	48235
90919-02234	U5100	48297
90919-02237	U5086	48273
90919-02238	U5068	48240
90919-02239	U5029	48107
90919-02240	U5027	48095
90919-02243	U5052	48184
90919-02244	U5052	48184
90919-02247	U5090	48278
90919-02248	U5090	48278
90919-02250	U5084	48269
90919-02251	U5076	48257
90919-02252	U5145	48395
90919-02255	U5076	48257
90919-02256	U5084	48269
90919-02258	U5145	48395
90919-02262	U5029	48107
90919-02265	U5027	48095
90919-02266	U5052	48184
90919-19023	U5052	48184
90919-A2001	U5090	48278

VW GROUP	NGK → STOCK No.		VW GROUP	NGK → STOCK No.	
04E905110A	U5153	48408	077905115B	U5024	48088
04E905110B	U5153	48408	077905115C	U5024	48088
04E905110C	U5153	48408	077905115E	U5024	48088
04E905110D	U5153	48408	077905115F	U5024	48088
04E905110E	U5153	48408	077905115H	U5024	48088
04E905110F	U5153	48408	077905115K	U5024	48088
04E905110H	U5153	48408	077905115P	U5024	48088
04E905110J	U5153	48408	077905115Q	U5024	48088
04E905110K	U5153	48408	077905115T	U5024	48088
04E905110L	U5153	48408	078905101C	U2013	48049
04E905110M	U5153	48408	078905104	U2010	48037
058905101	U5004	48008	07C905115C	U5017	48047
058905101A	U6037	48048	07C905115D	U5017	48047
058905105	U5004	48008	07C905115E	U5017	48047
058905105A	U6037	48048	07C905115F	U5017	48047
066905100B	U5046	48165	07C905115H	U5017	48047
066905100C	U5046	48165	07C905115J	U5017	48047
066905100D	U5046	48165	07C905715	U5017	48047
066905100G	U5046	48165	07C905715A	U5017	48047
06A905097	U2011	48038	07K905115B	U5015	48042
06A905104	U2011	48038	07K905715	U5015	48042
06A905115	U5003	48005	07K905715A	U5015	48042
06A905115A	U5003	48005	07K905715B	U5015	48042
06A905115B	U5003	48005	07K905715C	U5015	48042
06A905115C	U5003	48005	07K905715D	U5015	48042
06A905115D	U5003	48005	07K905715E	U5015	48042
06B905105	U5022	48082	07K905715F	U5015	48042
06B905115	U5022	48082	07K905715J	U5015	48042
06B905115B	U5022	48082	115914010	U1072	48309
06B905115E	U5022	48082	171 905 115	U1065	48302
06B905115G	U5003	48005	171 905 115 A	U1066	48303
06B905115H	U5003	48005	211 905 115B	U1078	48341
06B905115J	U5003	48005	211 905 115D	U1080	48343
06B905115L	U5003	48005	251 905 115A	U1078	48341
06B905115N	U5003	48005	272 906 00 60	U5117	48337
06B905115R	U5003	48005	357905104	U1001	48000
06B905115S	U5003	48005	36905715	U5002	48003
06B905115T	U5003	48005	489051051	U2006	48025
06B905116J	U5003	48005	66905100	U5046	48165
06B905117L	U5003	48005	6N0905104	U1001	48000
06C905115B	U5013	48040	701 905 104	U1003	48039
06C905115E	U5014	48041	701 905 104A	U1003	48039
06C905115F	U5013	48040	811 905 115	U1081	48344
06C905115G	U5013	48040	867 905 104	U1001	48000
06C905115H	U5013	48040	867 905 104A	U1001	48000
06C905115K	U5013	48040	867 905 105A	U1003	48039
06C905115L	U5013	48040	955 602 101 05	U5020	48065
06C905115M	U5013	48040	J9091902197	U1018	48105
06C905115N	U5013	48040	SE028915.000B	U3008	48060
06D905115C	U5014	48041	SE141915000A	U1079	48342
06D905115D	U5014	48041			
06D905115F	U5014	48041			
06D905115G	U5014	48041			
06D905115K	U5014	48041			
06E905115	U5014	48041			
06E905115A	U5014	48041			
06E905115B	U5014	48041			
06E905115C	U5014	48041			
06E905115D	U5014	48041			
06E905115E	U5014	48041			
06F905115	U5015	48042			
06F905115A	U5015	48042			
06F905115B	U5015	48042			
06F905115C	U5015	48042			
06F905115E	U5015	48042			
06F905115F	U5015	48042			
06F905115G	U5015	48042			
06H905110D	U5154	48409			
06H905110E	U5154	48409			
06H905110F	U5154	48409			
06H905110G	U5154	48409			
06H905199A	U5154	48409			
071905106	U2033	48150			
077905115AB	U5024	48088			

YUGO - see ZASTAVA**ZASTAVA NGK → STOCK No.**

1610283 U1079 48342

facebook.com/ngksparkplugsuk



twitter.com/ngk_uk



NGK UK YouTube



ngkntk.co.uk



WE'VE GOT HER BACK

'Go Charlie' Martin - Championnat
de France de la Montagne hillclimb



IGNITION
PARTS



VEHICLE
ELECTRONICS

SPARK PLUGS : GLOW PLUGS : COILS : SENSORS FROM THE WORLD'S NO.1

THE NO.1 CHOICE THE WORLD OVER

NGK Spark Plugs (UK) Limited
Maylands Avenue
Hemel Hempstead
Hertfordshire
HP2 4SD

Tel: 01442 281000
Fax: 01442 281001



IGNITION
PARTS

www.ngkntk.co.uk