



SPARK PLUG COVERS

STANDARD PLUG COVERS



EPDM RUBBER PLUG COVERS



The NGK range of resistor covers are designed to give perfect noise suppression across all frequencies whilst engine performance is not adversely affected whatsoever.

Featuring a resistor element pressed in between the plug terminal and the high tension wire connection, the construction is extremely durable, the resistor element is long enough to prevent interior flashover, and steady resistance is maintained. Superlative ceramic materials are incorporated that resist deterioration and have small resistance variation under over-load, whilst the plug connector is made of sturdy phenolic resin, practically oblivious to tremendous heat and high tension, and very rugged rubber material. The heat press insertion makes the construction all the more tough and vibration-resistant. Special rubber liners on both ends prevent moisture from causing electrical leakage.

All motorcycle manufacturers now comply with current legislation which demands a standard of noise suppression on every vehicle. This is achieved usually by fitting NGK resistor covers though in many cases a combination of NGK resistor covers and NGK resistor spark plugs (R type) is necessary to satisfy the ministry tests. It is emphasized that despite the use of both resistor covers and spark plugs in such engines, due to the unique and superior construction of NGK products there is no loss of performance or shortening of service life.

LBO5EMH and SDO5FM being of tough EPDM rubber construction are intended for competition/trial applications.

COVER SYMBOLS EXPLANATION CHART

L		B		10		E		H		F	
External appearance		Suitable Ø Plug Thread		Resistance		Suitable Terminal Type		Special Feature			
L	90° Elbow Type	B	14 mm minimum	None	Non-resistor	E	Terminal nut or solid post	A	Special design		
S	Straight	C	10 mm minimum	01	1 k Ω	F	Terminal stud	H	Compact type		
X	102° Elbow Std.	D	10 & 12 mm	05	5 k Ω			P	Special waterproof cover		
V	120° Elbow (Long)	Z	10, 12 & 14 mm	10	10 k Ω			K	Silicon waterproof cover		
Y	120° Elbow (Short)							M	Rubber sheathed		
T	'T' Type							G	With rubber grommet		
								W	Double connector springs		
								F	For Ø 5mm HT cable		
								L	Inductive resistor type		
								Y	With handle		
								Z	Special design		

NGK RESISTOR PLUG COVERS

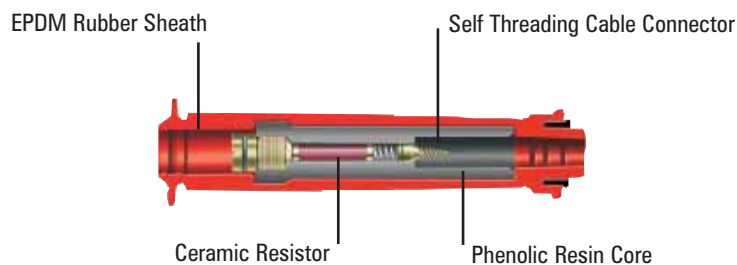
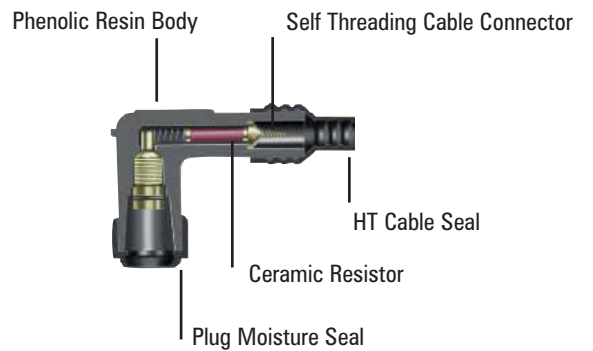
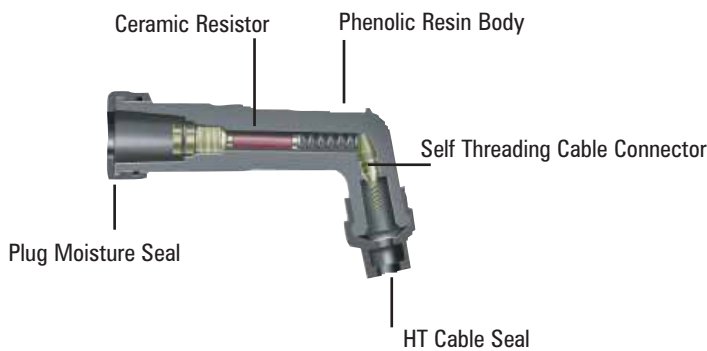

See pages 94 to 95 for full range of plug covers

SPARK PLUG COVERS

Part No.	Stock No.	Colour	Resistor	Ø Plug	Terminal Type
LB05E	8031	Black	5 kΩ	14mm	
LB05E-R	8898	Red	5 kΩ	14mm	
LB05F	8051	Black	5 kΩ	14mm	
LB05F-R	8854	Red	5 kΩ	14mm	

Description: 90° Elbow Type

Material: Phenolic Resin

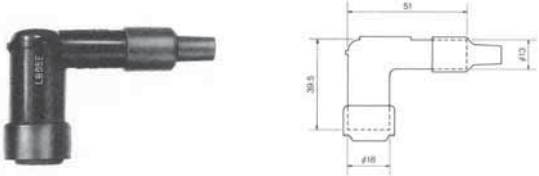

Part No.	Stock No.	Colour	Resistor	Ø Plug	Terminal Type
LZFH	8710	Black	None	10 - 14mm	

Description: 90° Non-resistor type

Material: Phenolic Resin

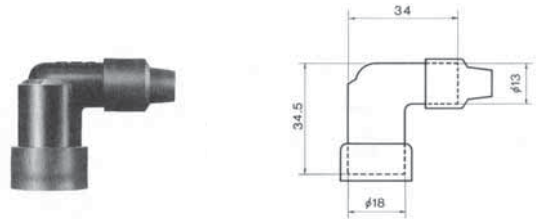

Part No.	Stock No.	Colour	Resistor	Ø Plug	Terminal Type
LB05EH	8334	Black	5 kΩ	14mm	
LB05EH-R	8688	Red	5 kΩ	14mm	
LB10EHF	8055	Black	10 kΩ	14mm	
LB10EHF-R	8058	Red	10 kΩ	14mm	

Description: 90° Elbow Type

Material: Phenolic Resin

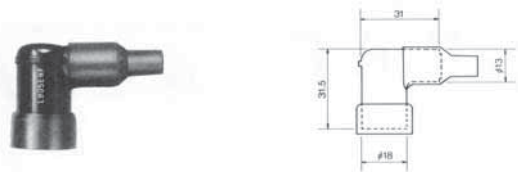

Part No.	Stock No.	Colour	Resistor	Ø Plug	Terminal Type
LB05EMH	8338	Black	5 kΩ	14mm	
LB05EMH-R	8160	Red	5 kΩ	14mm	

Description: 90° Rubber Sheathed

Material: EPDM Rubber

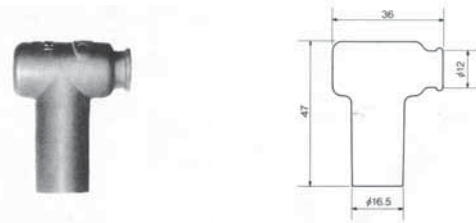

Part No.	Stock No.	Colour	Resistor	Ø Plug	Terminal Type
LD05F	8060	Black	5 kΩ	10 - 12mm	
LD05F-R	8231	Red	5 kΩ	10 - 12mm	

Description: 90° Elbow Type

Material: Phenolic Resin

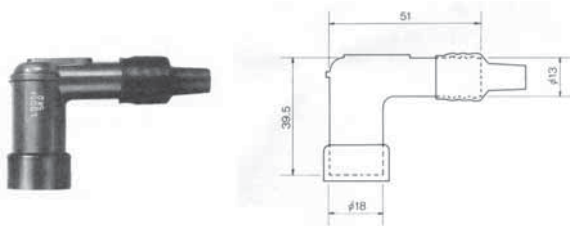

Part No.	Stock No.	Colour	Resistor	Ø Plug	Terminal Type
SB05E	8374	Black	5 kΩ	14mm	
SB05EC	8511	Red	5 kΩ	14mm	
SB05F	8080	Black	5 kΩ	14mm	
SB05F-R	8567	Red	5 kΩ	14mm	
SD05F	8022	Black	5 kΩ	10 - 12mm	
SD05F-R	8238	Red	5 kΩ	10 - 12mm	

Description: Straight Type

Material: Phenolic Resin



Part No.	Stock No.	Colour	Resistor	Ø Plug	Terminal Type
SD05FM	8392	Black	5 kΩ	10 - 12mm	
SD05FM-R	8673	Red	5 kΩ	10 - 12mm	

Description: Straight Rubber Sheathed

Material: EPDM Rubber

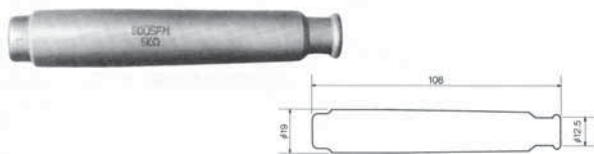

Part No.	Stock No.	Colour	Resistor	Ø Plug	Terminal Type
TB05EMA	8636	Black	5 kΩ	14mm	

Description: 90° Rubber Sheathed

Material: Silicon Rubber

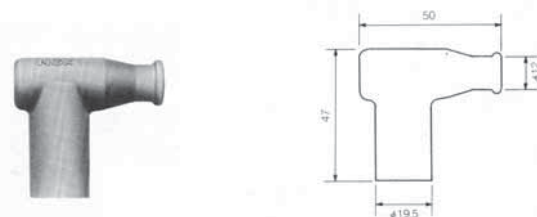

SPARK PLUG COVERS

Part No.	Stock No.	Colour	Resistor	Ø Plug	Terminal Type
XB05F	8062	Black	5 kΩ	14mm	
XB05F-R	8592	Red	5 kΩ	14mm	
XD05F	8072	Black	5 kΩ	10 - 12mm	
XD05F-R	8768	Red	5 kΩ	10 - 12mm	

Description: 102° Elbow Type Material: Phenolic Resin

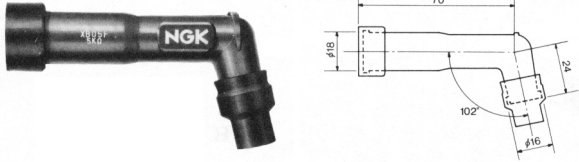

Part No.	Stock No.	Colour	Resistor	Ø Plug	Terminal Type
VB05F	8032	Black	5 kΩ	14mm	
VB05F-R	8759	Red	5 kΩ	14mm	
VD05F	8052	Black	5 kΩ	10 - 12mm	
VD05F-R	8376	Red	5 kΩ	10 - 12mm	

Description: 120° Elbow (Long) Type Material: Phenolic Resin

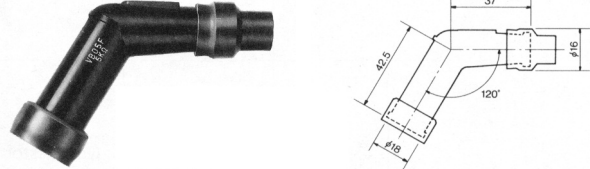

Part No.	Stock No.	Colour	Resistor	Ø Plug	Terminal Type
YB05F	8082	Black	5 kΩ	14mm	
YB05F-R	8162	Red	5 kΩ	14mm	

Description: 120° Elbow (Short) Type Material: Phenolic Resin

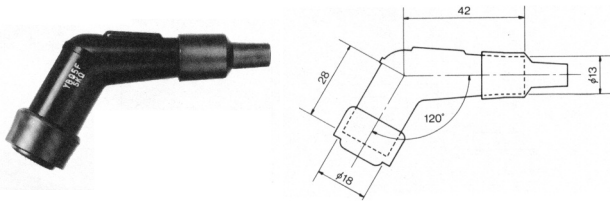

Part No.	Stock No.	Colour	Resistor	Ø Plug	Terminal Type
LBER-R	8307	Red	None	14mm	
LBER-B	8308	Blue	None	14mm	

Description: 90° Rubber Sheathed Material: Silicon Rubber

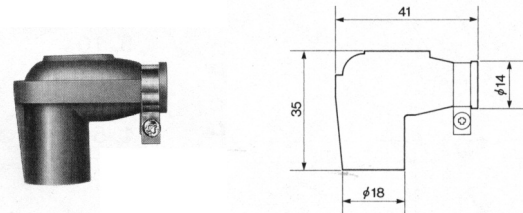

Part No.	Stock No.	Colour	Resistor	Ø Plug	Terminal Type
TRS1225-B	8787	Blue	5 kΩ	14mm	Special*

Description: 90° Compact Type Material: Silicon Rubber

***Suitable for use with R6120-□ racing spark plugs only**
***Suitable for use with R7282-□ racing spark plugs only**

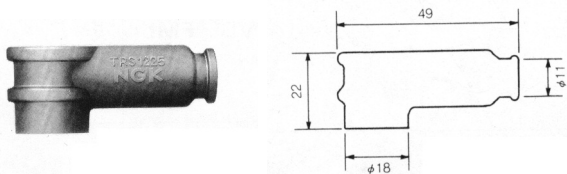

Part No.	Stock No.	Colour	Resistor	Ø Plug	Terminal Type
TRS1408F-B	8871	Blue	5 kΩ	14mm	Special*

Description: 90° Compact Type Material: Silicon Rubber

***Suitable for use with R5300A-□ racing spark plugs only**

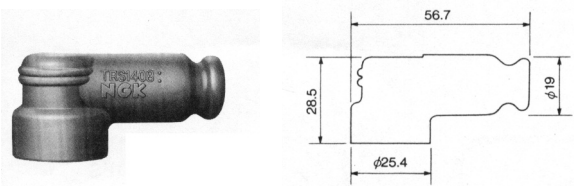

Part No.	Stock No.	Colour	Resistor	Ø Plug	Terminal Type
TRS1409-R	8733	Red	None	14mm	

Description: 90° Compact Type Material: Silicon Rubber

***Suitable for use with R5540F-□ racing spark plugs**

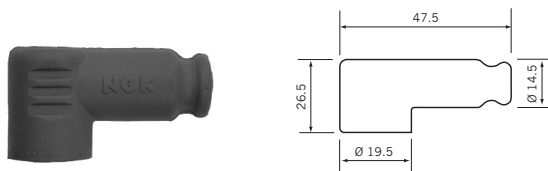

Part No.	Stock No.	Colour	Resistor	Ø Plug	Terminal Type
SD05EG	5818	Black	5 kΩ	10 - 12mm	

Description: Straight Type Material: Phenolic Resin

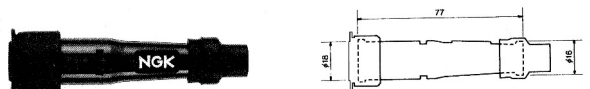

PLUG COVER SUPERSESSIONS

Current Part No.	Stock Number	replaced by	Replacement Part No.	Stock Number
LB05E (red)	8898	→	LB05E-R	8898
LB05EH (red)	8688	→	LB05EH-R	8688
LB05EMH (red)	8160	→	LB05EMH-R	8160
LB05F (red)	8854	→	LB05F-R	8854
LB10EHF (red)	8058	→	LB10EHF-R	8058
LBER (blue)	8308	→	LBER-B	8308
LBER (red)	8307	→	LBER-R	8307
LD05F (red)	8231	→	LD05F-R	8231
SB05F (red)	8567	→	SB05F-R	8567
SD05F (red)	8238	→	SD05F-R	8238
SD05FM (red)	8673	→	SD05FM-R	8673
TRS1225	8787	→	TRS1225-B	8787
TRS1408F	8871	→	TRS1408F-B	8871
TRS1409	8733	→	TRS1409-R	8733
VB05F (red)	8759	→	VB05F-R	8759
VD05F (red)	8376	→	VD05F-R	8376
XB05F (red)	8592	→	XB05F-R	8592
XD05F (red)	8768	→	XD05F-R	8768
YB05F (red)	8162	→	YB05F-R	8162

To assist in identifying the red or blue coloured variant for popular plug covers a small change to the descriptive part number has been instigated. Implementation will be managed on a running change basis i.e. when current stocks are exhausted orders will be fulfilled by supplying the replacement item. There is no change to the Stock Number. Black covers which are considered standard are unaffected.